

PACCAR PX-7

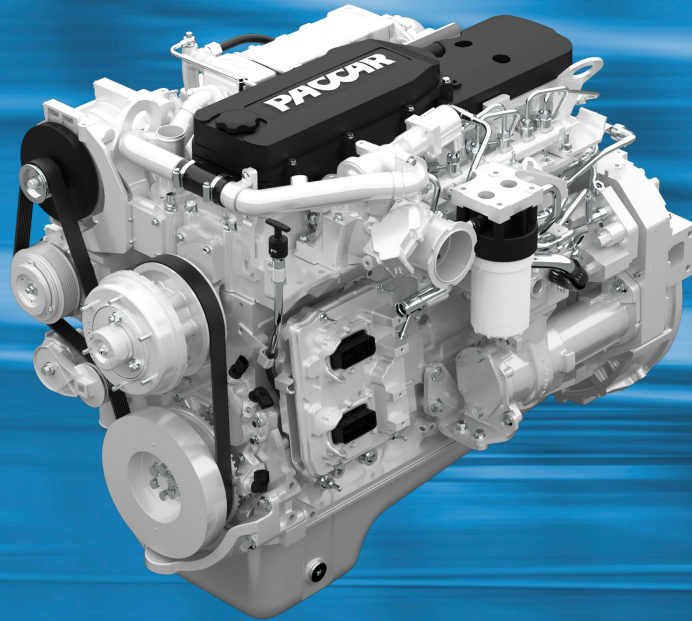

Operator's Manual

Contents

Safety

1

Emergency

2

Controls

3

Driving

4

Maintenance

5

Information

6

Index

7

Contents

©2012 Paccar Inc - All Rights Reserved

This manual illustrates and describes the operation of features or equipment which may be either standard or optional on this vehicle. This manual may also include a description of features and equipment which are no longer available or were not ordered on this vehicle. Please disregard any illustrations or descriptions relating to features or equipment which are not on this vehicle.

PACCAR reserves the right to discontinue, change specifications, or change the design of its vehicles at any time without notice and without incurring any obligation.

The information contained in this manual is proprietary to PACCAR. Reproduction, in whole or in part, by any means is strictly prohibited without prior written authorization from PACCAR Inc.

INTRODUCTION

Safety Alerts	1-3
Illustrations.	1-5
Foreword	1-6
Important Reference Numbers	1-7
General Safety Instructions.	1-9
Acronyms and Abbreviations	1-12
Unique Operating Characteristics of an Engine with On-Board Diagnostic	1-13

INTRODUCTION

Safety Alerts

Please read and follow all of the safety alerts contained in this manual. They are there for your protection and information. These alerts can help you avoid injury to yourself, your passengers, and help prevent costly damage to the vehicle. Safety alerts are highlighted by safety alert symbols and signal words such as "**WARNING**", "**CAUTION**", or "**NOTE**". Please do not ignore any of these alerts.

WARNING



The safety alert following this symbol and signal word provides a warning against operating procedures which could cause death or injury. They could also cause equipment or property damage. The alert will identify the hazard, how to avoid it, and the probable consequence of not avoiding the hazard.

Example:

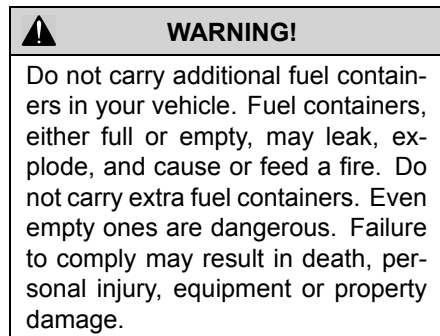

INTRODUCTION

1

CAUTION

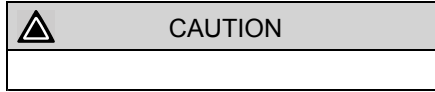

The safety alert following this symbol and signal word provides a caution against operating procedures which could cause equipment or property damage. The alert will identify the hazard, how to avoid it, and the probable consequence of not avoiding the hazard.

Example:

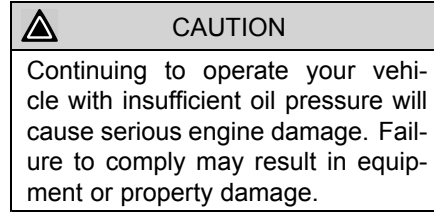

NOTE

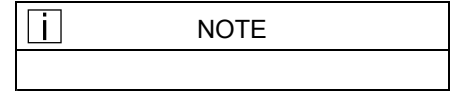

The alert following this symbol and signal word provides important information that is not safety related but should be followed. The alert will highlight things that may not be obvious and is useful to your efficient operation of the vehicle.

Example:

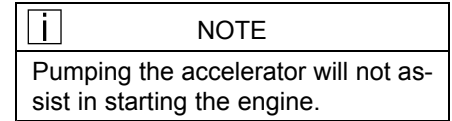

Illustrations

General Information

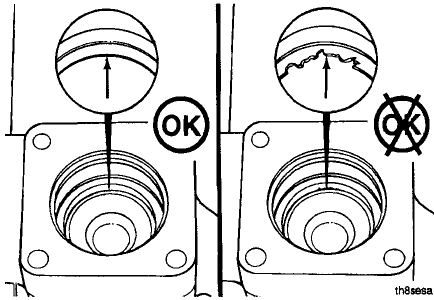

Some of the illustrations throughout this manual are generic and will **not** look exactly like the engine or parts used in your application. The illustrations can contain symbols to indicate an action required and an acceptable or **not** acceptable condition.

The illustrations are intended to show repair or replacement procedures. The procedure will be the same for all applications, although the illustration can differ.

INTRODUCTION

1

Foreword

This manual contains information for the correct operation and maintenance of your PACCAR engine. Read and follow all safety instructions. Refer to the WARNING in the “General Safety Instructions” beginning on page 1-9. Keep this manual with the equipment. If the equipment is traded or sold, give the manual to the new owner. The information, specifications, and recommended maintenance guidelines in this manual are based on information in effect at the time of printing. PACCAR reserves the right to make changes at any time without obligation.

If you find differences between your engine and the information in this manual, contact your local PACCAR Authorized Repair Location or write to PACCAR c/o PACCAR Engines, PO Box 1518, Bellevue, WA 98009. The latest technology and the highest quality components were used to produce this engine. When replacement parts are needed, we recommend using only genuine parts from PACCAR.

i	NOTE
Warranty information including the EPA and California Emission Warranty is located in the section entitled “WARRANTY” on page 6-8. Make sure you are familiar with the warranty or warranties applicable to your engine.	

Important Reference Numbers

Fill in the part name and number in the blank spaces provided below. This will give you a reference whenever service or maintenance is required.

Part Name	Number
Engine Model (See Engine Identification on page 6-3.)	
Engine Serial Number (ESN) (See Engine Identification on page 6-3.)	
Oil Type (See Lubricating Oil Recommendations and Specifications on page 5-25.)	
Filter Part Numbers:	
Air Cleaner Element	
Lubricating Oil (See Lubricating Oil Recommendations and Specifications on page 5-25.)	
Fuel (Use ultra-low sulfur diesel fuel only) (See Acceptable Types of Fuels on page 5-21.)	

INTRODUCTION

1

Coolant (See Coolant Recommendations and Specifications on page 5-30.)	
Belt Part Numbers:	

General Safety Instructions

Important Safety Notice



WARNING!

Improper practices, carelessness, or ignoring any warnings may cause death, personal injury, equipment or property damage.

Read and understand all of the safety precautions and warnings before performing any repair. This list contains the general safety precautions that must be followed to provide personal safety. Special safety precautions are included in the procedures when they apply.

- Work areas should be dry, well lit, ventilated, free from clutter, loose tools, parts, ignition sources and hazardous substances. Be aware of hazardous conditions that can exist.
- Wear protective glasses and protective shoes when working.
- Rotating parts can cause cuts, mutilation or strangulation.
- Do not wear loose-fitting or torn clothing. Remove all jewelry when working.
- Before beginning any repair, disconnect the battery (negative [-] cable) and discharge any capacitors.
- Disconnect the air starting motor if equipped to prevent accidental engine starting.
- Put a "**DO NOT OPERATE**" tag in the operator's compartment or on the controls.
- Use the proper tool for manually rotating the engine. Do not attempt to rotate the crankshaft by pulling or prying on the fan. This practice can cause death, personal injury, equipment damage, or damage to the fan blade(s), causing premature fan failure.
- Allow the engine to cool before slowly loosening the coolant filler cap to relieve the pressure from the cooling system.
- Always use blocks or proper stands to support the vehicle or vehicle components before performing any service work. Do not work on anything that is supported only by lifting jacks or a hoist.
- Before removing or disconnecting any lines, fittings, or related items, relieve all pressure in the air, oil, fuel, and cooling systems. Remain alert for possible pressure when disconnecting any device from a system that contains pressure. High pressure oil or fuel can cause death or personal injury.

INTRODUCTION

1

- Always wear protective clothing when working on any refrigerant lines and make sure that the workplace is in a well-ventilated area. Inhalation of fumes can cause death or personal injury. To protect the environment, liquid refrigerant systems must be properly emptied and filled using equipment that prevents the release of refrigerant gas. Federal law requires capturing and recycling refrigerant.
 - To reduce the possibility of personal injury, use a hoist or get assistance when lifting components that weigh 23 kg [50 lb] or more. Ensure all lifting devices such as chains, hooks, or slings are in good condition and are of the correct load capacity. Make sure any lifting devices are positioned correctly. Always use a spreader bar when necessary.
- The lifting hooks must not be side-loaded.
- Corrosion inhibitors and lubricating oils may contain alkali. Do not get the substance in eyes and avoid prolonged or repeated contact with skin. Do not swallow. In case of contact, immediately wash skin with soap and water. In case of harmful contact, immediately contact a physician. **Always keep any chemicals OUT OF REACH OF CHILDREN.**
 - Naptha and Methyl Ethyl Ketone (MEK) are flammable materials and must be used with caution. Follow the manufacturer's instructions to ensure safety when using these materials. **Always keep any chemicals OUT OF REACH OF CHILDREN.**
 - When working on the vehicle, be alert for hot parts on systems that have just been turned off, exhaust gas flow, and hot fluids in lines, tubes, and compartments. Contact with any hot surface may cause burns.
- Always use tools that are in good condition. Make sure you have the proper understanding of how to use the tools before performing any service work. Use **ONLY** genuine replacement parts from PACCAR.
 - Always use the same fastener part number (or equivalent) when replacing items. Do not use a fastener of lesser quality if replacements are necessary.
 - Do not perform any repair when impaired, tired, fatigued or after consuming alcohol or drugs that can impair your functioning.
 - Some state and federal agencies in the United States of America have determined that used engine

- oil can be carcinogenic and can cause reproductive toxicity. Avoid inhalation of vapors, ingestion, and prolonged contact with used engine oil.
- Liquefied petroleum gas is heavier than air and can accumulate near the floor, in sumps, and low-lying areas.
 - Natural gas is lighter than air and can accumulate under hood and awnings.
 - To reduce the possibility of suffocation and frostbite, wear protective clothing and ONLY disconnect natural gas and liquefied petroleum gas lines in a well-ventilated area.
 - Do not connect the jumper starting or battery charging cables to any ignition or governor control wiring. This can cause electrical damage to the ignition or governor.
 - Always torque fasteners and fuel connections to the required specifications. Overtightening or under-tightening can allow leakage. Close the manual fuel valves prior to performing maintenance and repairs, and when storing the vehicle inside.
 - Coolant is toxic. If not reused, dispose of coolant in accordance with local environmental regulations.
 - The Diesel Exhaust Fluid contains urea. Do not get the substance in your eyes. In case of contact, immediately flood eyes with large amounts of water for a minimum of 15 minutes. Avoid prolonged contact with skin. In case of contact, immediately wash skin with soap and water. Do not swallow internally. In the event the Diesel Exhaust Fluid is ingested, contact a physician immediately.
 - California Proposition 65 Warning - Diesel engine exhaust and some of its constituents are known to the State of California to cause cancer, birth defects, and other reproductive harm.
 - The catalyst substrate located in the Diesel Particulate Filter contains Vanadium Pentoxide. Vanadium Pentoxide has been determined by the State of California to cause cancer. Always wear protective clothing and eye protection when handling the catalyst assembly. Dispose of the catalyst in accordance with local regulations. If catalyst material gets into the eyes, immediately flood eyes with water for a minimum of 15 minutes. Avoid prolonged contact with skin. In case of contact, immediately wash skin with soap and water. In case of harmful contact, immediately contact a physician.



CAUTION

Corrosive chemicals can damage the engine. Do not use corrosive chemicals on the engine. Failure to comply may result in equipment or property damage.

Acronyms and Abbreviations

General Information

The following list contains some of the acronyms and abbreviations used in this manual.

API	American Petroleum Institute
ASTM	American Society of Testing and Materials
ATS	After-Treatment System
BTU	British Thermal Unit
°C	Celsius
CARB	California Air Resources Board
CCA	Cold Cranking Amperes
C.I.D.	Cubic Inch Displacement
CPL	Control Parts List
cSt	Centistokes
DEF	Diesel Exhaust Fluid
DOC	Diesel Oxidation Catalyst
DPF	Diesel Particulate Filter
ECM	Electronic Control Module
EGR	Exhaust Gas Recirculation
ELC	Extended Life Coolant
EMI	Electromagnetic Interference
EPA	Environmental Protection Agency
ESN	Engine Serial Number

°F	Fahrenheit
FMI	Failure Mode Identifier
ft-lb	Foot-Pound Force
GVW	Gross Vehicle Weight
HEST	High Exhaust System Temperature
Hg	Mercury
hp	Horsepower
H ₂ O	Water
ICM	Ignition Control Module
inHg	Inches of Mercury
in H ₂ O	Inches of Water
km/l	Kilometers per Liter
kPa	Kilopascal
LTA	Low Temperature Aftercooling
MPa	Megapascal
mph	Miles Per Hour
mpq	Miles Per Quart
N·m	Newton-meter
NG	Natural Gas
NOx	Mono-Nitrogen Oxides
O ₂	Oxygen
OBD	On-Board Diagnostics
OEM	Original Equipment Manufacturer
PID	Parameter Identification Descriptions
ppm	Parts Per Million
psi	Pounds Per Square Inch
PTO	Power Takeoff
REPTO	Rear Power Take Off
RGT	Rear Gear Train

rpm	Revolutions Per Minute
SAE	Society of Automotive Engineers
SCA	Supplemental Coolant Additive
SCR	Selective Catalytic Reduction
SID	Subsystem Identification Descriptions
STC	Step Timing Control
VDC	Volts of Direct Current
VGt	Variable Geometry Turbocharger
VS	Variable Speed
VSS	Vehicle Speed Sensor

Unique Operating Characteristics of an Engine with On-Board Diagnostic General Information

The engines supported by this manual are required to meet Heavy Duty On-Board Diagnostics (OBD) regulations. EPA HD OBD is required for all U.S. vehicles with a gross vehicle weight over 6350 kg [14,000 lb].

OBD exists to make sure the engine is operating within emissions limits. OBD continuously monitors the engine and aftertreatment system to detect malfunctions that adversely affect emissions. Once a malfunction is detected, a malfunction indicator lamp (MIL) illuminates to inform the driver of the malfunction and a fault code, which identifies the likely malfunction, is stored in the engine control module (ECM).

An OBD system operates in a manner very similar to the traditional PACCAR diagnostic system. Both systems store fault codes, induce derates when required to protect the engine and aftertreatment from further damage, and illuminate dashboard lamps. These fault codes are used by the service channel for troubleshooting and repair.

The differences between an OBD system and the traditional PACCAR diagnostic system are that an OBD system:

- illuminates the MIL
- detects deteriorated components and systems (not just total malfunctions)
- performs multiple trip diagnostics

Multiple trip diagnostics are malfunctions that must occur in

INTRODUCTION

1

multiple consecutive trips before the MIL is illuminated. A trip is a condition or operating state the engine must operate for the OBD fault code to gather information and determine if a malfunction has occurred. The MIL turns on when an OBD fault code is logged, and in most cases, it requires three trips without a malfunction occurrence to clear the lamp.

For more information on the MIL and what the operator should do when the MIL illuminates, see Malfunction Indicator Lamp on page 3-4.

WHAT TO DO IF...

You Need Roadside Assistance 2-3
Stop Engine Lamp Turns On 2-3
Engine Oil Pressure Lamp Turns On. 2-4
Check Engine Lamp Turns On 2-5
Engine is Overheating 2-5

WHAT TO DO IF...

You Need Roadside Assistance

Call toll-FREE to talk to someone at the PACCAR Customer Center. The toll-FREE telephone number is located on the windshield decal.

- Open 24-7-365 days a year
- They can help you get roadside assistance.
- They have a custom mapping system which locates authorized PACCAR engine dealers and Independent Service Providers (ISPs) near you and lists types of services offered, hours of operation and contact information.

- They can assist with jump and pull starts, tires, trailers, fines and permits, chains, towing, hazardous clean-up, out of fuel (roadside), mechanical repairs and preventive maintenance services.
- They have multilingual agents and access to a translation service to ensure quality assistance for customers who speak any language.
- They can't answer your warranty questions but can get you in contact with an authorized dealer who can.
- The PACCAR Customer Center service is FREE.

Stop Engine Lamp Turns On



If the Stop Engine warning lamp illuminates, it means you have a serious engine system problem.



WARNING!

This should be considered an emergency. You should stop the vehicle as safely as possible and turn "OFF" the ignition. The vehicle must be serviced and the problem corrected before driving again. Failure to do so may result in personal injury, severe engine damage, equipment or property damage.

Engine Oil Pressure Lamp Turns On



It is important to maintain oil pressure within acceptable limits. If oil pressure drops below the minimum psi a Red Warning Lamp on the oil pressure gauge and the Stop Engine Lamp will come ON.



CAUTION

Continuing to operate your vehicle with insufficient oil pressure may cause severe engine damage, equipment or property damage.

- If the oil pressure fails to rise within 10 seconds after the engine starts, stop the engine and determine the cause.

- See Lubricating Oil System on page 5-17, for the correct oil pressure ranges for your vehicle's engine.
- If the oil pressure suddenly drops, or the audible alarm and engine oil pressure warning light come on while driving, do the following:
 1. Slow down carefully.
 2. Move a safe distance off the road and stop.
 3. Place the transmission in neutral and set the parking brake. (See Parking Brake Valve and OPERATING THE TRANSMISSION in your vehicle Operator's Manual, for transmission shifting and parking brake information.)
 4. Turn "OFF" the engine.
 5. Turn "ON" the emergency flasher and use other warning devices to alert other motorists.
 6. Wait a few minutes to allow oil to drain into the engine oil pan, and then check the oil level. (See Inspection of the Engine Oil Level on page 5-3.)
 7. Add oil if necessary. If the problem persists, contact an authorized PACCAR engine dealer as soon as possible.

Check Engine Lamp Turns On



The Check Engine Lamp turns on when a problem exists, but the vehicle can still be safely driven. Vehicle should be serviced to correct the problem but the situation should not be considered an emergency.

Engine is Overheating



CAUTION

The cooling system may overheat if the engine coolant is at the minimum level. A sudden loss of coolant, caused by a split hose or broken hose clamp could also lead to an overheat condition. Always inspect to ensure hoses and clamps are not cracked, worn, or loose. Failure to comply may result in equipment or property damage.



NOTE

The system may also temporarily overheat during severe operating conditions such as:

- Climbing a hill on a hot day.
- Stopping after high-speed/high-load driving.
- Debris blocking air flow through the cooling module (radiator).

If the engine coolant temperature warning lamp comes on and the audible alarm sounds showing an overheat condition, or if you have any other reason to suspect the engine may be overheating, **DO NOT TURN OFF THE ENGINE** unless a low water warning device indicates a loss of coolant. Follow these steps:

1. Reduce engine speed or stop. When stopped, place the transmission in neutral and set the parking brake. See the vehicle operator's manual for instructions on transmission shifting and parking brake information.
2. Check to ensure that the oil pressure gauge reads normal.
3. Increase the engine speed to 1,100 to 1,200 rpm maximum for 2-3 minutes.
4. Monitor the engine temperature. After the temperature returns to

WHAT TO DO IF...

2

normal, allow the engine to idle 3-5 minutes before shutting it off. This allows the engine to cool gradually and uniformly.

5. If the overheating came from severe operating conditions, the temperature should have cooled by this time.
6. Check the coolant level at the cooling module surge tank.



WARNING!

Removing the surge tank fill cap while the engine is hot can be dangerous. Never remove the surge tank cap while the engine is still hot; you could be badly burned. Failure to comply may result in death, personal injury, equipment or property damage.

Removing the surge tank fill cap while the engine is too hot is dangerous. Scalding steam and fluid under pressure may escape and cause serious personal injuries. When removing the surge tank fill cap, follow these steps:

1. Wait until the coolant temperature is below 122°F [50°C].
2. Protect your face, hands, and arms by covering the cap with a large, thick rag to protect against escaping fluid and steam.
3. Carefully and slowly turn the cap one turn to allow excess pressure to escape, then push down and turn for final removal. See the vehicle operator's manual for instructions on checking and filling the cooling module surge tank.



WARNING!

To reduce the chance of personal injury and/or vehicle damage caused by engine overheating, never leave the engine idling when the vehicle is unattended. If the engine overheats, immediate action is required to correct the condition. Continued unattended operation of the engine, even for a short time, may result in serious engine damage or a fire. Failure to comply may result in death, personal injury, equipment or property damage.



CAUTION

Do not allow your engine to idle, at low rpm's (400-600 rpm), longer than five minutes. Long periods of idling after the engine has reached operating temperatures can decrease engine temperature and cause gummed piston rings, clogged injectors, and possible engine damage from lack of lubrication. The normal torsional vibrations generated by the engine can also cause transmission wear. If an engine must idle for an extended period of time, it should be done at fast idle (1,000 rpm or greater).



NOTE

An idle shutdown feature, available on PACCAR Engines, can be programmed to shut the engine down after a period of low idle speed operation with no driver activity. A flashing warning lamp will inform the driver of an impending shutdown.



NOTE

The power take off (PTO) feature, available on PACCAR engines, can be programmed to adjust engine idle speed with the use of switches to pre-programmed set points.

OPERATING INSTRUCTIONS

Engine Warning Lamps	3-3
Engine Operating Range	3-7
Engine Braking System	3-8

OPERATING INSTRUCTIONS

Engine Warning Lamps General Information

The following engine indicator lamps cover only the lamps controlled by the engine's ECM. The vehicle manufacturer can provide additional indicator lamps. Please refer to the vehicle's operator's manual for additional lamp information.

Wait-to-Start Lamp



The WAIT TO START lamp illuminates when the intake air heater (grid heater) needs to warm the intake air prior to starting the engine.

The WAIT TO START lamp "ON" time will vary depending on the ambient air temperature. See "Normal Starting Procedure" on page 4-4.

For vehicles equipped with an engine starting motor protection feature, another function of the WAIT TO START lamp is to flash for two minutes if the starting motor is engaged for 30 seconds or more.

The WAIT TO START lamp can look like:

- The words WAIT TO START spelled out
- A symbol similar to the graphic illustrated
- The color of the symbol or words can vary, based on the manufacturer of the vehicle, but will typically be red or amber.

OPERATING INSTRUCTIONS

Check Engine Lamp



3

The CHECK ENGINE lamp illuminates when the engine needs service at the first available opportunity.

The CHECK ENGINE lamp is amber, and can look like:

- The words WARNING or CHECK ENGINE spelled out.
- A symbol of an engine, similar to the graphic illustrated.

The CHECK ENGINE lamp is located on the face of the tachometer and illuminates when a problem exists, but the vehicle can still be safely driven. Vehicle should be serviced to correct the problem, but the situation should not be considered an emergency. The

Check Engine lamp will activate for several reasons. These include but are not limited to Water in Fuel and Diesel Particulate Filter (DPF) generation required.

Another function of the CHECK ENGINE lamp is to flash for 30 seconds at key ON when one of the following occurs. This flashing function is referred to as the MAINTENANCE lamp. The MAINTENANCE lamp could flash for any of the following reasons:

- Maintenance required (if the Maintenance Monitor is enabled)
- Water-in-fuel is detected
- Coolant level is low.

Malfunction Indicator Lamp

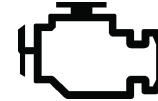

Illuminates when an engine emissions failure has occurred. The vehicle can be safely driven but should be serviced to correct the problem. The situation should not be considered an emergency. In some cases, the Malfunction Indicator Lamp will activate in conjunction with the High Exhaust Temperature, Diesel Particulate Filter (DPF) and Diesel Exhaust Fluid (DEF) Warning Lights.

Stop Engine Lamp



The STOP ENGINE lamp indicates, when illuminated, the need to stop the engine as soon as it can be safely done. **The engine must remain shut down until the engine can be repaired.**

For engines with the Engine Protection Shutdown feature enabled, if the STOP ENGINE lamp begins to flash, the engine will automatically shut down after 30 seconds. The flashing STOP engine lamp alerts the operator to the impending shutdown.

High Exhaust System Temperature (HEST) Warning Lamp



HEST Warning Lamp

Refer to Engine Aftertreatment Systems Operator's Manual for additional information.

Diesel Particulate Filter (DPF) Warning Lamp

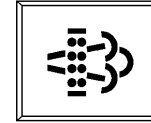

A flashing AFTERTREATMENT DIESEL PARTICULATE FILTER lamp indicates that the aftertreatment diesel particulate filter needs to be regenerated at the next possible opportunity. Engine power may be reduced automatically. When this lamp is flashing, the operator should:

1. Change to a more challenging duty cycle, such as highway driving, for at least 20 minutes.
2. Performing a stationary regeneration.

OPERATING INSTRUCTIONS

3

A flashing AFTERTREATMENT DIESEL PARTICULATE FILTER lamp combined with an illuminated WARNING or CHECK ENGINE lamp indicates that the aftertreatment diesel particulate filter needs be regenerated immediately. Engine power will be reduced automatically.

When these lamps are illuminated, a stationary regeneration is required.

i	NOTE
If a stationary regeneration is not performed, the STOP ENGINE lamp will illuminate and the vehicle will need to be taken to an authorized repair location.	

Refer to Engine Aftertreatment Systems Operator's Manual for additional information.

Diesel Exhaust Fluid (DEF) Lamp



Diesel Exhaust Fluid (DEF) Lamp

The AFTERTREATMENT DIESEL EXHAUST FLUID lamp indicates, when illuminated or flashing, that the diesel exhaust fluid level is low.

An illuminated AFTERTREATMENT DIESEL EXHAUST FLUID lamp indicates that the diesel exhaust fluid level has fallen below the initial warning level. This can be corrected by filling the diesel exhaust fluid tank with diesel exhaust fluid.

i	NOTE
It is recommended that the diesel exhaust fluid tank be filled completely full of diesel exhaust fluid in order to correct any fault conditions.	

A flashing AFTERTREATMENT DIESEL EXHAUST FLUID lamp indicates that the diesel exhaust fluid level has fallen below the critical warning level. This can be corrected by filling the diesel exhaust fluid tank with diesel exhaust fluid.

i	NOTE
It is recommended that the diesel exhaust fluid tank be filled completely full of diesel exhaust fluid in order to correct any fault conditions.	

A flashing AFTERTREATMENT DIESEL EXHAUST FLUID lamp combined with an illuminated WARNING or CHECK ENGINE lamp

indicates that the diesel exhaust fluid level has fallen below the initial derate level. The engine power will be limited automatically. This can be corrected by filling the diesel exhaust fluid tank with diesel exhaust fluid.

i	NOTE
It is recommended that the diesel exhaust fluid tank be filled completely full of diesel exhaust fluid in order to correct any fault conditions.	

Allowing the diesel exhaust fluid tank to become empty will cause the aftertreatment diesel exhaust fluid dosing system to lose prime. A loss of prime condition may cause fault codes to become active.

i	NOTE
On OBD certified products, the MIL may become illuminated for a loss of prime condition.	

i	NOTE
It is recommended that the diesel exhaust fluid tank be filled completely full of diesel exhaust fluid in order to correct any fault conditions.	

Refer to Engine Aftertreatment Systems Operator's Manual for additional information.

Engine Operating Range General Information

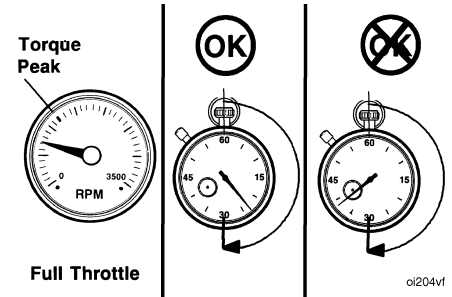

⚠	CAUTION
Operating the engine at full throttle below peak torque will shorten engine life to overhaul, can cause serious engine damage, and is considered engine abuse. Do not operate the engine at full throttle operation below peak torque rpm for more than 30 seconds. Failure to comply may result in equipment or property damage.	

OPERATING INSTRUCTIONS

PACCAR engines are designed to operate at full throttle under momentary conditions down to peak torque engine speed. This is consistent with recommended operating practices.

3



CAUTION

Operating the engine beyond the maximum engine speed can cause severe engine damage. Use proper operating techniques for the vehicle to prevent engine overspeed. The maximum engine speed specification is listed in the "General Engine Specifications" on page 5-16. Failure to comply may result in equipment or property damage.

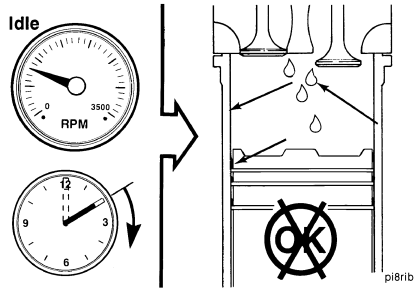

CAUTION

Do not idle the engine for excessively long periods. Long periods of idling, more than 10 minutes, can cause poor engine performance.

Engine Braking System Variable Geometry Turbo (VGT) Brake System General Information

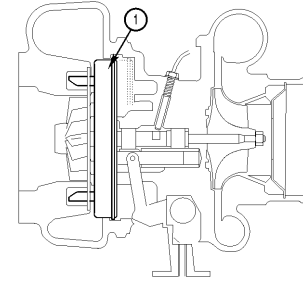

10d00376

1. Sliding Nozzle

This engine may be equipped with a variable geometry turbocharger (VGT) with an exhaust brake feature. This feature allows the variable geometry turbocharger to act as an exhaust brake by retarding the speed of the engine to provide additional vehicle braking power and extend the life of the vehicle service brakes. The

ON/OFF function is controlled by a switch located on the dash of the vehicle. The engine (VGT) exhaust brake works by retarding engine speed by creating high exhaust back pressure. This back pressure is obtained by restricting airflow through the turbine housing of the turbocharger. This restriction through the turbine housing of the turbocharger is created through positioning of the sliding nozzle (1) located internally to the variable geometry turbocharger (VGT). The position of the sliding nozzle is controlled by the engine electronic control module (ECM). This option may not be available on your vehicle.



WARNING!

The exhaust brake is not intended as the primary brake for the vehicle, nor is it an emergency brake. The service brakes must be used in an emergency. Relying solely on the exhaust brake to stop the vehicle in an emergency could cause an accident and lead to personal injury. The exhaust brake only helps the service brakes by using pressure to slow the drive train. You must use the service brakes for quick or emergency stops. Failure to comply may result in death, personal injury, equipment or property damage.



WARNING!

Do not use the exhaust brake when operating on surface with poor traction (such as wet, icy or snow covered roads). Retarders can cause the wheels to skid on a slippery surface. You could lose control of the vehicle and jackknife if the wheels begin to skid, resulting in an accident. Failure to comply may result in death, personal injury, equipment or property damage.

OPERATING INSTRUCTIONS

3



WARNING!

Do not use an exhaust brake when driving bobtail or with an unloaded trailer. There may not be enough weight on the rear axle to provide traction. This could cause a loss of control and jackknife resulting in an injury accident. Make sure the exhaust brake is switched "OFF" when bobtailing or with an unloaded trailer. Failure to comply may result in death, personal injury, equipment or property damage.



NOTE

When the engine (VGT) exhaust brake switch is in the "ON" position, the engine's electronic control module (ECM) monitors inputs (such as accelerator pedal position and engine speed). From these inputs, the ECM determines when to enable the engine (VGT) exhaust brake feature when the proper braking conditions are present.

Other features/switches like cruise control, can also affect when the engine (VGT) exhaust brake activates. For more information on how the engine (VGT) exhaust brake functions, refer to vehicle operation manual or contact a PACCAR Authorized Repair Location.



WARNING!

To reduce the possibility of personal injury or property damage, always be prepared to use the vehicle service brakes for emergency stopping. The safe control speed of a vehicle will vary with the size of the load, the type of load, the grade, and the road conditions. Failure to comply may result in death, personal injury, equipment or property damage.



NOTE

The exhaust brake can only be activated when the accelerator pedal is at its low idle position. With the throttle at low idle position, fueling commands to the cylinders will not detract from the braking power of the brake system.

i NOTE

The engine (VGT) exhaust brake is designed to assist the vehicle's service brakes when slowing the vehicle to a stop.

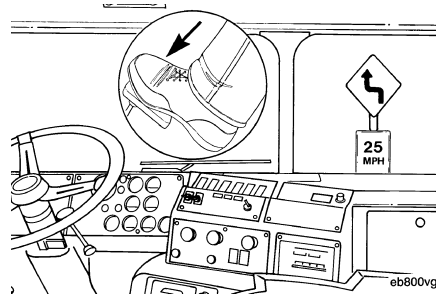
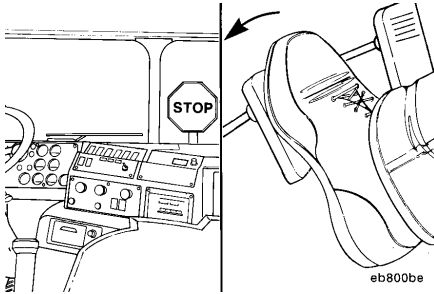

Vehicle service brakes must always be used. The engine brake is not intended to be used as the primary brake of the vehicle, nor is it an emergency brake. The engine retarder only helps the service brakes by using pressure to slow the drivetrain. Use the service brakes for quick stops.

⚠ CAUTION

Exceeding governed engine speed can cause engine damage. Operating the engine beyond the maximum engine speed may cause serious engine damage and is considered engine abuse. Use the engine and vehicle braking systems to control engine speed.

OPERATING INSTRUCTIONS

The optimum braking power of the engine (VGT) exhaust brake is reached at rated engine speed. Correct gear selection, therefore, is critical.

Typically, on vehicles equipped with automatic transmissions, the engine electronic control module (ECM) and the transmission will determine the correct gear selection.

3

DRIVING INSTRUCTIONS

General Information 4-3

Normal Starting Procedure 4-4

Cold Weather Starting 4-9

Starting Procedure After Extended Shutdown or Oil
Change 4-9

Operating the Engine 4-10

Cold Weather 4-13

Engine Shutdown 4-15

Electromagnetic Interference (EMI) 4-15

Tips for Operation on Level and Dry Pavement 4-17

Tips for Operation on Grades with Dry Pavement 4-18

Tips for Operation on Slick Roads 4-20

DRIVING INSTRUCTIONS

General Information

Correct care of your engine will result in longer life, better performance, and more economical operation.

Follow the daily maintenance checks listed in "Maintenance Schedule" on page 5-3.

The new PACCAR engine associated with this manual does not require a "break-in" procedure. This section of the manual provides all of the necessary information required for proper engine operation.

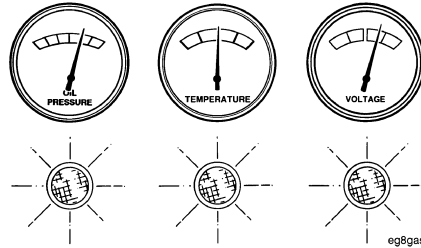

Check the oil pressure indicators, temperature indicators, warning lights, and other gauges daily to make sure they are operational.

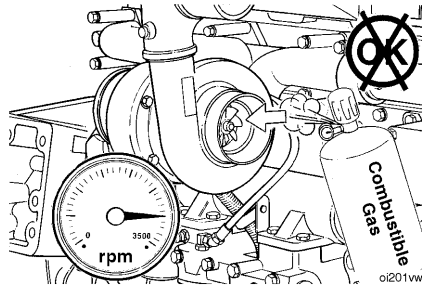

	WARNING!
<p>Combustible vapors near the air intake system could be ingested into the engine, causing the engine to suddenly accelerate and overspeed. This condition could result in operator losing control of the vehicle if an unexpected increase in engine rpm occurs. Combustible vapors could also cause a fire. Do not operate your vehicle in an area where combustible chemicals or vapors may be present. Failure to comply may result in death, personal injury, equipment or property damage.</p>	

IT IS THE RESPONSIBILITY OF THE OWNER AND OPERATOR TO OPERATE THE VEHICLE IN A SAFE ENVIRONMENT.

DRIVING INSTRUCTIONS

i	NOTE
Numerous safety devices (ie engine shutoff devices) are available to minimize the risk of engine overspeeding caused by combustible vapors being ingested into the air intake system.	

a combustible environment, such as from a fuel spill or gas leak.

Normal Starting Procedure Starting

Ensure the parking brake is set "ON" and the transmission shift lever is in neutral. For automatic transmissions that have park position, place the shift lever in park.

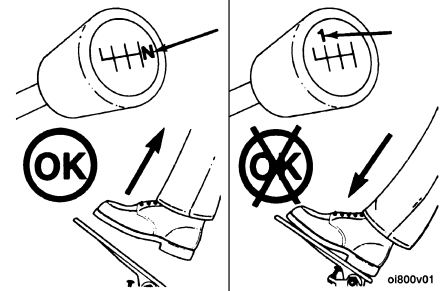

With the accelerator pedal in the idle position, turn the key switch to the "ON" position.

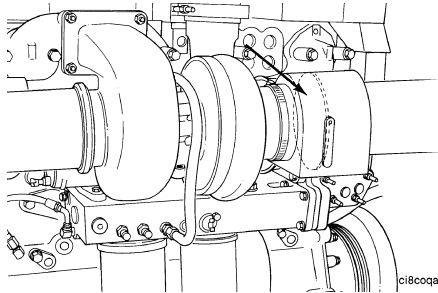

PACCAR recommends the installation of an air intake shutoff device or a similar safety device to minimize the risk of overspeeding, as can occur when the vehicle is being operated in

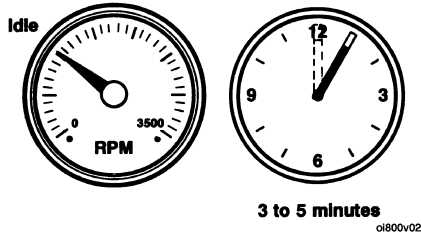

Idle the engine 3 to 5 minutes before operating with a load.

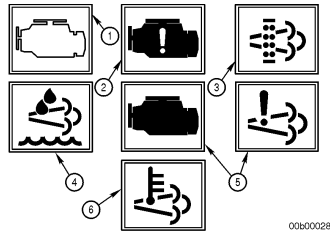

With the key in the "ON" position, the engine warning lamps will come on momentarily and then go out. The engine warning lamps include:

1. Check engine lamp; amber in color.
2. STOP engine lamp; red in color.
3. Aftertreatment Diesel Particulate Filter; yellow in color.
4. Aftertreatment Diesel Exhaust Fluid lamp; amber in color.
5. Malfunction Indicator lamp; amber in color.
6. High Exhaust System Temperature; amber in color.

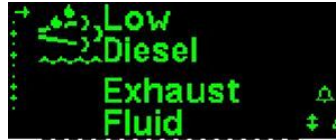

The DEF Warning screen is displayed when the DEF Fluid level has reached a critically low level. It may be suppressed by pushing enter on the MCS (Menu Control Switch). This

warning may be accompanied by the DEF Level in the low range, DEF Lamp on solid or flashing, the Check Engine lamp, the Stop Engine lamp, the MIL lamp, and/or engine derate.

If any of the lamps remain on or begin to flash, refer to "Engine Indicator Lamps" on page 3-3.

DRIVING INSTRUCTIONS



Under cold conditions, the Wait-to-Start lamp will illuminate at key on, and will stay on for a period of up to 30 seconds.

4



NOTE

The length of time the Wait-to-Start lamp remains illuminated depends on the ambient temperature. The lower the ambient temperature, the longer the lamp will be illuminated.

Once the Wait-to-Start lamp turns off, turn the key to the starting position to start the engine.



NOTE

Some engines are equipped with an engine starting motor protection feature. If the starting motor is engaged for 30 or more seconds, without the engine starting, the starter will be locked out from operating, allowing for proper cooling of the starting motor. During this time, the WAIT TO START lamp will flash for 2 minutes. Once the lamp discontinues flashing, the starting motor will be allowed to function.



NOTE

Engines equipped with air starting motors require a minimum of 480 kPa [70 psi].



CAUTION

Engaging the starter motor for more than 30 seconds may cause it to overheat and can damage the starter motor. Never engage the starter motor for more than 30 seconds and wait 2 minutes between each attempt to start the engine to allow the starter motor to cool. This caution does not apply to air starters.



CAUTION

The engine must have adequate oil pressure within 15 seconds after starting the engine. If the oil pressure gauge does not register the minimum pressure, or drops below the minimum pressure, a red warning light in the gauge will come on, a warning buzzer will sound, and the Stop Engine Lamp will come on. This should be considered an emergency. Operating the engine in this condition may cause severe engine damage. You should stop the vehicle as safely as possible. The vehicle must be serviced and the problem corrected before driving again.

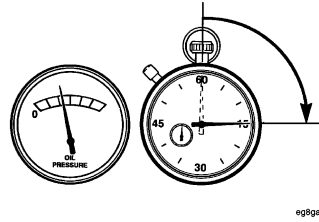

eg8gask

Idle the engine 3 to 5 minutes before operating with a load.

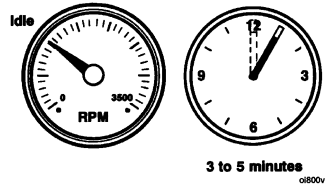

3 to 5 minutes
01800v02

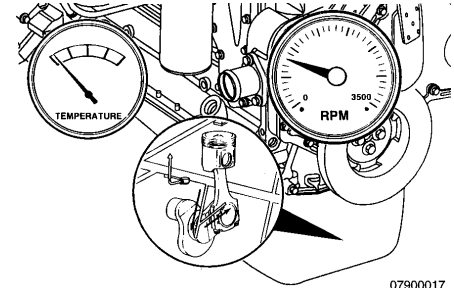

07900017

After starting a cold engine, increase the engine speed (rpm) slowly to provide adequate lubrication to the bearings and to allow the oil pressure to stabilize.

DRIVING INSTRUCTIONS

4

i	NOTE
<p>For engines equipped with the engine warm-up protection feature; this feature limits engine speed and torque following engine start-up until sufficient oil pressure is available to the engine components. This feature reduces the risk of engine part damage due to operating at engine speeds too high or loads before adequate oil pressure is achieved.</p>	

Some engines are equipped with a Fast Idle Warm Up feature. When enabled, this feature elevates the idle speed of the engine in cold ambient conditions, in order to shorten the time necessary to warm up the engine. When the idle speed is elevated, the engine noise may change, this is normal. To bring the engine back to low idle speed:

- For vehicles equipped with a manual transmission and clutch switch: Depress the clutch pedal.
- For vehicles equipped with a brake switch: Depress the service brake pedal.
- Depress the accelerator pedal.

For more information on the Fast Idle Warm Up feature, contact a PACCAR authorized repair location.

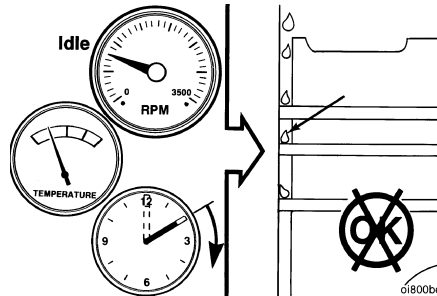

⚠	CAUTION
<p>Do not operate the engine at low idle for long periods with engine coolant temperature below the minimum specification in “Cooling System” on page 5-18. This can result in the following:</p> <ul style="list-style-type: none">• Fuel dilution of the lubricating oil.• Carbon build up in the cylinder.• Cylinder head valve sticking.• Reduced performance. <p>If an engine must idle for an extended period of time, it should be done at fast idle (1,000 rpm or greater) until the coolant temperature meets the specification.</p>	

Cold Weather Starting

General Information



CAUTION

To reduce the possibility of damage to the lubricating oil pan, due to the composite materials used in the manufacture of the lubricating oil pan, under no circumstances should an external heat source be applied directly or indirectly to the lubricating oil pan.

Follow the Normal Starting Procedure in this section. If equipped with an intake air heater, the Wait-To-Start lamp will stay on longer.

Refer to the vehicle operator's manual instructions for any additional cold weather starting procedures.

Using Starting Aids

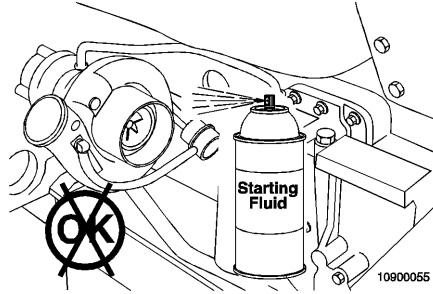

This engine is equipped with an intake grid heater to help start the engine in cold weather conditions. Contact your authorized PACCAR repair location for other cold weather starting aid options.



WARNING!

Using starting fluid to help start the engine could cause a fire or explosion, resulting in personal injury, property damage and severe engine damage. Do not use starting fluid to start this engine.

Starting Procedure After Extended Shutdown or Oil Change

General Information

Follow the Normal Starting Procedure in this section. The engine will run at idle only until the minimum oil pressure is detected by the ECM. It can take more cranking time to start the engine after an extended shut down or oil change.

DRIVING INSTRUCTIONS

Operating the Engine

Normal

Monitor the oil pressure and coolant temperature gauges frequently. Refer to “Lubricating Oil System” on page 5-17 and “Cooling System” on page 5-18 for recommended operating pressures and temperatures. Shut off the engine if any pressure or temperature does **not** meet the specifications.

Continuous operation with engine coolant temperature above or below the engine coolant temperature specifications listed in “Cooling System” on page 5-18 can damage the engine.

Engine Overheating



CAUTION

The cooling system may overheat if the engine coolant is at the minimum level. A sudden loss of coolant, caused by a split hose or broken hose clamp could also lead to an overheat condition. Always inspect to ensure hoses and clamps are not cracked, worn, or loose. Failure to comply may result in equipment or property damage.



NOTE

The system may also temporarily overheat during severe operations conditions such as:

- Climbing a hill on a hot day.
- Stopping after high-speed/high-load driving.
- Debris blocking air flow through the cooling module (radiator).

4

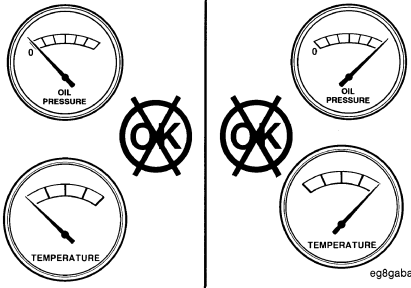

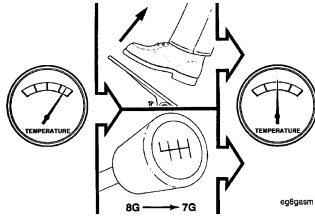

If an overheating condition starts to occur, reduce the power output of the engine by releasing the accelerator pedal or shifting the transmission to a lower gear, or both, until the temperature returns to the normal operating range. If the engine temperature does not return to normal, shut off the engine, and refer to Troubleshooting Symptoms, or contact a PACCAR Authorized Repair Location.

i	NOTE
<p>If the engine coolant temperature warning lamp comes on and the audible alarm sounds showing an overheat condition, or if you have any other reason to suspect the engine may be overheating, DO NOT TURN OFF THE ENGINE unless a low water warning device indicates a loss of coolant. Follow these steps:</p>	

1. Reduce engine speed or stop. When stopped, place the transmission in neutral and set the parking brake. See the vehicle operator's manual for instructions on transmission shifting and parking brake information.
2. Check to ensure that the oil pressure gauge reads normal.
3. Increase the engine speed to about one-half of full operating speed, or 1,100 to 1,200 rpm, maximum for 2-3 minutes.

4. Return the engine speed to normal idle after two or three minutes.
5. Monitor the engine temperature. After the temperature returns to normal, allow the engine to idle 3-5 minutes before shutting it off. This allows the engine to cool gradually and uniformly.
6. If the overheating came from severe operating conditions, the temperature should have cooled by this time.
7. Check the sight gauge (glass level indicator) on the side of the coolant expansion tank.

DRIVING INSTRUCTIONS



CAUTION

Never leave the engine idling when the vehicle is unattended. If the engine should overheat, immediate action is required to correct the condition. Failure to take immediate action may result in serious engine damage. If you must leave your vehicle unattended, shut down the engine.

4



WARNING!

Removing the radiator fill cap while the engine is hot can be dangerous. Never remove the radiator tank cap while the engine is still hot; you could be badly burned. Failure to comply may result in death, personal injury, equipment or property damage.

Removing the surge tank fill cap while the engine is too hot is dangerous. Scalding steam and fluid under pressure may escape and cause

serious personal injuries. When removing the surge tank fill cap, follow these steps:

1. Wait until the coolant temperature is below 122°F [50°C].
2. Protect your face, hands, and arms by covering the cap with a large, thick rag to protect against escaping fluid and steam.
3. Carefully and slowly turn the cap one turn to allow excess pressure to escape, then push down and turn for final removal. See the vehicle operator's manual for instructions on checking and filling the cooling module surge tank.

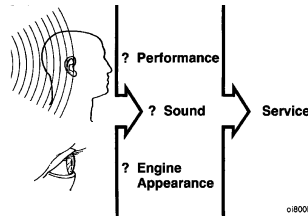



Take the time to learn what normal operating conditions are for your engine so that when an abnormal condition arises, you will be able to recognize it as such and take the appropriate action.

Most failures give an early warning. Look and listen for changes in performance, sound, or engine appearance that can indicate service or engine repair is needed. Some changes to look for are:

- Engine misfires.
- Vibration.
- Unusual engine noises.
- Sudden changes in engine operating temperatures or pressures.
- Excessive smoke.
- Loss of power.

- An increase in oil consumption.
- An increase in fuel consumption.
- Fuel, oil, or coolant leaks.

 CAUTION
Do not allow your engine to idle, at low rpm's (400-600 rpm), longer than five minutes. Long periods of idling after the engine has reached operating temperatures can decrease engine temperature and cause gummed piston rings, clogged injectors, and possible engine damage from lack of lubrication. The normal torsional vibrations generated by the engine can also cause transmission wear. If an engine must idle for an extended period of time, it should be done at fast idle (1,000 rpm or greater).

 NOTE
An idle shutdown feature, available on PACCAR Engines, can be programmed to shut the engine down after a period of low idle speed operation with no driver activity. A flashing warning lamp will inform the driver of an impending shutdown. If the truck is equipped with PTO equipment, the idle shutdown system can be deactivated when the PTO is operational; however, engine low RPM idle periods should not exceed 5 minutes whenever possible.

 NOTE
The power take off (PTO) feature, available on PACCAR engines, can be programmed to adjust engine idle speed with the use of switches to pre-programmed set points.

Cold Weather

It is possible to operate engines in extremely cold environments if they are properly prepared and maintained. Satisfactory performance of an engine in low ambient temperature conditions requires modification of the engine, surrounding equipment, operating practices and maintenance procedures.

The correct engine coolant, lubricating oil and fuels must be used for the cold weather range in which the engine is being operated. See the Maintenance Section on page 5-3 for these critical engine fluids recommendations and specifications.

DRIVING INSTRUCTIONS

Cold Weather Operating Aids

The following cold weather operating aids are required for cold weather situations:

4

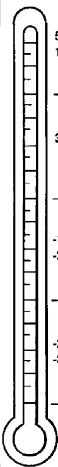
Cold Weather Operating Aids										
Temperature	Starting Aid	Coolant Heater	Oil Heater	Under-hood Air	Fuel Heater	Battery Heater	Radiator Shutters	Engine Enclosure	Winter Front	Thermostatic Fan
 50 to 32° F 10 to 0° C <hr/> 32 to -10° F 0 to -23° C <hr/> -10 to -25° F -23 to -32° C <hr/> -25 to -65° F -32 to -54° C										
		↑	↑	↑	↑	↑	↑	↑	↑	↑
	Required	Required	Required	Required	Required	Required	Required	Required	Required	Required
		↓	↓	↓	↓	↓	↓	↓	↓	↓
* Required dependent upon viscosity/pour point.										
oi202vj										

Engine Shutdown Before Stopping the Engine

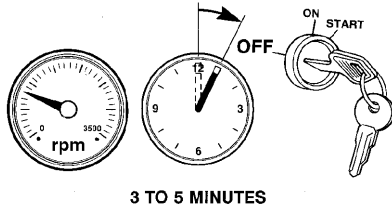

©i800v05

Allow the engine to idle 3 to 5 minutes before shutting it off after a full-load operation. This allows adequate cool down of pistons, cylinders, bearings, and turbocharger components. You will greatly increase its service life.

	NOTE
<p>For engines equipped with an electronic control module (ECM) ensure the key switch is turned off for a minimum of 70 seconds prior to disconnecting the continuous (unswitched) battery power supply. If the unswitched battery power supply is disconnected in less than 70 seconds after the key switch is turned off, active fault codes and incorrect ECM information can occur.</p>	

Turn the ignition switch to the OFF position. If the engine does not shut down, refer to Troubleshooting Symptom (Section TS) in the appropriate maintenance manual.

	CAUTION
<p>Failure to follow the correct shutdown procedure may result in damage to the turbocharger and shorten the turbocharger life.</p>	

Electromagnetic Interference (EMI) General Information

If not installed correctly, some vehicle accessories (CB radios, mobile transmitters, etc.) can generate and use radio frequency energy that may cause electromagnetic interference (EMI) between the accessory and the electronic controlled fuel system. Under these conditions, PACCAR is not liable for any performance problems with either the fuel system or the accessory. EMI is not considered by PACCAR to be an engine failure and therefore is not warrantable.

DRIVING INSTRUCTIONS

System EMI Susceptibility

PACCAR products are designed and tested for minimum sensitivity to incoming electromagnetic energy. The fuel system EMI susceptibility has been designed with a high tolerance against EMI and in most normal circumstances, if not all, electromagnetic energy-emitting devices that meet the Federal Communications Commission legal requirements should cause no interference.

System EMI Radiation Levels

Electronic components are required to pass various PACCAR and industry EMI specifications. Our testing has shown that when the engine is properly installed and maintained, it will not interfere with properly installed onboard communication equipment.

If any interference condition is noticed, follow these suggestions to reduce the amount of EMI:

1. Locate the accessory receiving antenna further away.
2. Check with the accessory supplier representative in your area to:
 - Accurately calibrate the accessory for proper frequency, power output, and sensitivity.

- Determine the optimum antenna location by obtaining antenna reflective energy data measurements.
- Ensure that the optimum antenna type and mounting arrangement is being used.
- Ensure the accessory equipment is properly constructed for maximum filtering to reject incoming electromagnetic noise.

Tips for Operation on Level and Dry Pavement



WARNING!

Do not use the engine brake when operating on road surfaces with poor traction (such as wet, icy, or snow covered roads or gravel). Retarders can cause the wheels to skid on a slippery surface. You could lose control of the vehicle and/or jackknife if the wheels begin to skid, resulting in an accident. Failure to comply may result in death, personal injury, equipment or property damage.



WARNING!

Do not use an engine brake when driving bobtail or with an unloaded trailer. There may not be enough weight on the rear axle to provide traction. This could cause a loss of control and jackknife resulting in an injury accident. Make sure the engine brake is switched "OFF" when bobtailing or with an unloaded trailer. Failure to comply may result in death, personal injury, equipment or property damage.

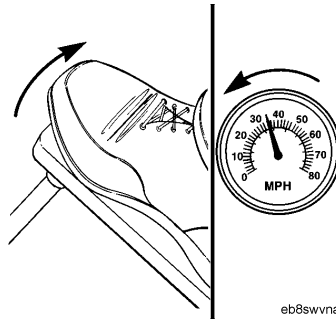

eb8swvna

To reduce vehicle speed, put the engine brake ON/OFF switch in the "ON" position. Remove your foot from the accelerator pedal and clutch pedal. The engine brakes will immediately begin to operate, slowing the vehicle.

For operation on dry and relatively flat surfaces, when greater retarding power is not required, put the two-position selector switch in the "LOW" position.

For operation on dry pavement when maximum retarding power is required, put the two-position selector switch in the "HI" position.

DRIVING INSTRUCTIONS

Tips for Operation on Grades with Dry Pavement

4



WARNING!

The engine brake is not intended as the primary brake for the vehicle, nor is it an emergency brake. The service brakes must be used in an emergency. Relying solely on the engine brake to stop the vehicle in an emergency could cause an accident and lead to personal injury. The engine brake only helps the service brakes by using pressure to slow the drive train. You must use the service brakes for quick or emergency stops. Failure to comply may result in death, personal injury, equipment or property damage.



WARNING!

Do not use the engine brake when operating on surface with poor traction (such as wet, icy, or snow covered roads). Retarders can cause the wheels to skid on a slippery surface. You could lose control of the vehicle and jackknife if the wheels begin to skid, resulting in an accident. Failure to comply may result in death, personal injury, equipment or property damage.



WARNING!

Do not use an engine brake when driving bobtail or with an unloaded trailer. There may not be enough weight on the rear axle to provide traction. This could cause a loss of control and jackknife resulting in an injury accident. Make sure the engine brake is switched "OFF" when bobtailing or with an unloaded trailer. Failure to comply may result in death, personal injury, equipment or property damage.

Control speed is the speed at which the forces pushing a vehicle down a grade are equal to the forces holding it back.

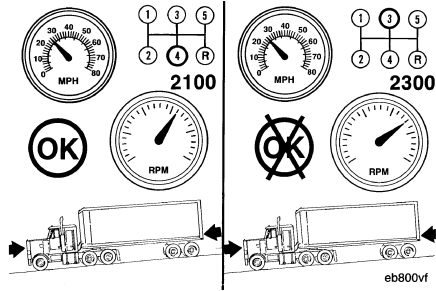

CAUTION

Never exceed governed engine speed because engine damage can occur. Operating engine beyond the governed speed causes additional strain on valve train and internal engine components. Operate the engine within governed engine speed.

NOTE

Once you have determined what the safe speed is for your vehicle, operate the engine brakes with the transmission in the lowest gear that will not cause the engine speed to exceed the rated engine speed. The optimum braking power of the engine brakes is reached at rated engine speed. Correct gear selection, therefore, is critical.

The two-position selector switch can be used to vary braking power as road conditions change.

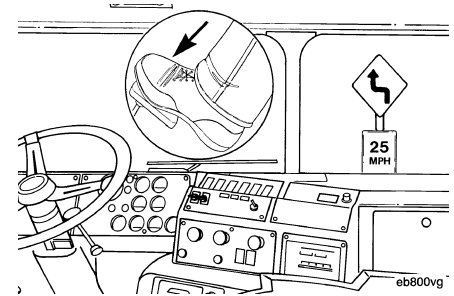

The engine brake is **NOT** intended as the primary brake for the vehicle, nor is it an emergency brake. The engine brake only helps the service brakes by using pressure to slow the drivetrain. Use the service brakes for quick stops.

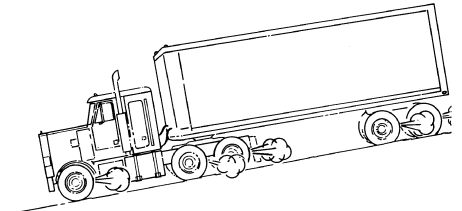

DRIVING INSTRUCTIONS

4



WARNING!

Do not drive with frequent or continuous use of the service brakes. This can overheat the brakes and result in excessive lining wear, increased stopping distances, possibly an accident and may lead to personal injury. Before descending a steep grade, shift to a lower gear, keep the vehicle speed low, and avoid continuous application to the brakes. Failure to comply may result in death, personal injury, equipment or property damage.



NOTE

The longer or steeper the hill, the more important it is to use your engine brakes. Make maximum use of your engine brakes by gearing down and letting the engine brakes do the work.

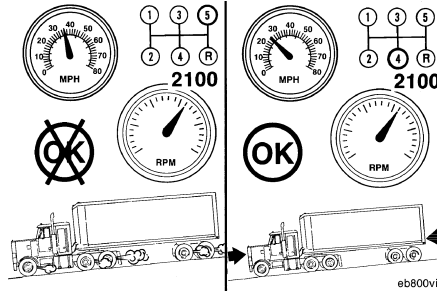

If frequent use of the vehicle service brakes is required, it is recommended that a slower control speed be used by selecting a lower transmission gear.

Tips for Operation on Slick Roads

The operation of any vehicle is difficult to predict on slick roads. The first 10 to 15 minutes of rainfall are the most dangerous, as road dirt and oil mixed with rain create a very slippery surface.

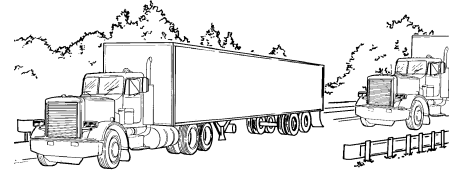

eb800bc



WARNING!

Do not operate the engine brake when driving/operating your vehicle bobtail or with a loaded or unloaded trailer on road surfaces with poor traction (wet, icy, or snow covered roads) or in heavy traffic. Braking caused by the normal operation of the engine brake could cause you to lose control of the vehicle resulting in an injury accident. Failure to comply may result in death, personal injury, equipment or property damage.

When driving on slick roads, start with the ON/OFF switch in the "OFF" position and the two-position selector switch in the "LOW" position.

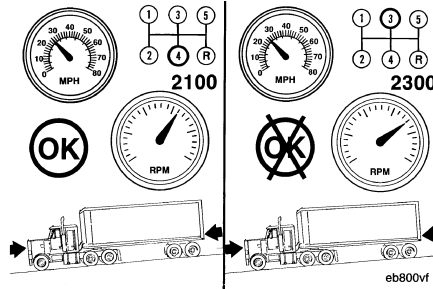

If your tractor is equipped with a twin-screw rear axle, position the power divider switch in the unlocked position.

Remove your foot from the accelerator pedal to make sure the vehicle will maintain traction with the retarding power of the engine alone.

If the vehicle drive wheels begin to skid or if there is a fishtailing motion, do not activate the engine brakes.

If traction is maintained using the retarding power of the engine alone and more braking power is required, switch the two-position selector switch to the "LOW" position and activate the engine brakes by switching the ON/OFF switch to the "ON" position.

If the vehicle's drive wheels begin to skid or there is a fishtailing motion, switch the ON/OFF switch to the "OFF" position.

If traction is maintained when the engine brakes are activated and more braking power is required, move the two-position selector switch to the "HI" position.

DRIVING INSTRUCTIONS

Again, if the vehicle has lost traction or if there is a fishtailing motion, switch the ON/OFF switch to the "OFF" position. Do not attempt to use the engine brakes in the "HI" position.

MAINTENANCE GUIDELINES

Overview 5-3
Maintenance Schedule 5-3
Maintenance Record Form 5-15

Maintenance Specifications

General Engine Specifications 5-16
Lubricating Oil System. 5-17
Cooling System. 5-18
Filter Specifications 5-19
Diesel Exhaust Fluid Recommendations and
Specifications 5-19
Fuel Recommendations 5-21
Warranty and the Use of Biodiesel Fuel 5-24
Lubricating Oil Recommendations and Specifications 5-25
Coolant Recommendations and Specifications . . . 5-30

MAINTENANCE GUIDELINES

Overview

General Information

PACCAR recommends that the engine be maintained according to the maintenance schedule in this section.

If the engine is operating in ambient temperatures below 0°F [-18°C] or above 100°F [38°C], perform maintenance at shorter intervals. Shorter maintenance intervals are also required if the engine is operated in a dusty environment or if frequent stops are made.

Some of these maintenance procedures require special tools or must be completed by qualified personnel. Contact your local PACCAR authorized repair location for detailed information.

If your engine is equipped with a component or accessory not manufactured by PACCAR Inc, refer to the component manufacturer's maintenance recommendations.

Maintenance Schedule

General Information

Perform maintenance at whichever interval occurs first.

At each scheduled maintenance interval, perform all previous maintenance checks that are due for scheduled maintenance.

Use the Maintenance Record Form on page 5-15 to record maintenance performed on the engine.

MAINTENANCE GUIDELINES

Daily or Refueling – Maintenance Check

- Engine Lubrication Oil Level - Check/Correct
 - To check engine oil level, park vehicle on level ground and wait 5 minutes after shutting off engine.
 - Remove dipstick and wipe it off with a clean, lint free rag.
 - Reinsert dipstick all the way in and pull it out again to check oil level.
 - Correct oil level is between the low (L) and high (H) marks on the dipstick.
- Fuel – Water Separator (if installed) - Drain trapped water
- Crankcase Breather Tube - Check
- Aftertreatment Diesel Exhaust Fluid Level - Check

- Air Intake Piping – Inspect
 - Hose/Pipe condition – Chaffing, deterioration/signs of leaking
 - Hose clamps for tightness
 - Clearance to other components
- Aftertreatment Exhaust Piping – Inspect
 - Cracks
 - Clearance to other components (i.e. electrical harnesses, etc.)
 - Hose/pipe condition – deterioration/signs of leaking
- Air Tank and Reservoirs (if equipped) - Inspect
- Cooling Fan – Inspect
 - Cracks

- Clearance to other components
- Engine Coolant Level – Check/Correct

With the engine off and temperature cool:

- Check coolant level. It should be visible through the clear plastic surge tank.
- Add coolant as necessary by removing the pressure cap on the neck of the surge tank or sight glass.
- Replacement or top up coolant should have the same antifreeze concentration and corrosion inhibitor content as the original coolant in the cooling system.
- Never add 100% antifreeze to the cooling system. Always

dilute antifreeze to the correct concentration based on freeze protection before adding it to the cooling system. Adding or using 100% antifreeze in a cooling system may result in cooling system plugging and overheating problems.

- Diesel Emission Fluid (DEF) level – Check/Top Up:

	NOTE
It is recommended to top up DEF when refueling. See Engine Aftertreatment Systems Operator’s Manual for DEF information.	

- **Check for any signs of fluid leaks**
- Ensure all access caps/covers are installed and tight.

Every 12,000 km [7,500 mi], 250 Hours, or 3 months – Maintenance Check

- Air Cleaner Restriction - Check/Correct
 - Service filter element when air cleaner restriction gauge (option) locks in the extreme high position.
 - Hose/Pipe Condition - deterioration/signs of leaking
 - Hose Clamp torque
- Charge Air Piping - Check/Correct
 - Hose/Pipe Condition - deterioration/signs of leaking
 - Hose Clamps for tightness
 - Clearance to other components
- Charge Air Cooler - Check/Correct

- Cracked tubes or header
- Clogged fins/tubes
- Hose/Pipe Condition - deterioration/signs of leaking
- Hose clamp torque
- Exhaust system - Check/Correct
 - Check for leaks and proper support

MAINTENANCE GUIDELINES

Every 24,000 km [15,000 mi], 500 Hours, or 6 months – Maintenance Check

- Fuel Filter (Spin On type) - Replace¹
- Lubricating Oil – Change²
- Lubricating Oil Filters – Replace²
- Antifreeze Concentration - Check³
- Radiator Pressure Cap - Check
- Batteries – Check⁵
- Battery Cables and Connections – Check⁵
- Battery Condition - electrolyte level, cracks, signs of leaking, overcharging
- Harness/Cables - loose connections, corrosion, chafing, broken retention clips
- Battery Hold-Downs - for tightness

- Battery Box Mounting Bolt - torque

Every 48,000 km [30,000 mi], 1000 Hours, or 1 Year - Maintenance Check

- Drive Belts - Check/Correct
 - Belt condition - signs of wear/deterioration
 - Belt alignment
- Engine Coolant Antifreeze - Check
- Fan Belt Tensioner - Check/Correct
 - Mounting bolt torque
 - Tensioner maintains proper belt tension
- Air Compressor Carbon Build-up - Check/Correct
- Cooling System - Check
 - Radiator Pressure Cap - Check

- Coolant level
- Coolant Protection

i	NOTE
Test coolant at once per year to determine if the coolant must be replaced. If it is determined that the coolant should be replaced, make sure to flush the coolant system. Contact a PACCAR authorized repair location for flushing the coolant system.	

Every 96,000 km [60,000 mi], 2000 Hours, - Maintenance Check

- Crankcase Breather Element - Change

Every 96,000 km [60,000 mi], 2000 Hours, or 2 Years - Maintenance Check

- Cooling System - Drain/Flush/Fill³
- Engine Steam Cleaning - Clean
- Air Compressor Discharge Lines - Clean
- Radiator Hoses – Check
 - Hose condition - deterioration/signs of leaking
 - Hose clamp torque
- Crankshaft Vibration Damper - Check⁴
 - Damper for cracks, nicks, gouges
 - Condition of damper rubber isolator
 - Damper fastener torque

MAINTENANCE GUIDELINES

Every 125,000 km [75,000 mi], 2,500 Hours, or 2 Years – Maintenance Check

- Crankcase Ventilation Filter – Replace

Every 241,000 km [150,000 mi], 5,000 Hours, or 4 Years – Maintenance Check

- Overhead Set – Adjust
- Exhaust System - Change
 - Replace exhaust flex pipe(s)

Every 321,500 km [200,000 mi], 6500 Hours – Maintenance Check

- Aftertreatment Diesel Particulate Filter (DPF) - Clean⁴
 - Complete Cleaning of filter using a DPF cleaning machine
 - Replace filter if necessary
- Aftertreatment Diesel Exhaust Fluid (DEF) Dosing Unit (DEF Module) Filter – Replace

Every 1,200,000 km [750,000 mi], 22,000 Hours, or 6 years – Maintenance Check

- Change extended life coolant
 **(See note 3 below)

i	NOTE
Refer to the following footnotes when referenced in the preceding maintenance schedules.	

1. *If the oil drain interval being used is greater than 24,000 km [15,000 mi], as determined by the Oil Drain Intervals section below, the fuel filter change can be extended until the oil drain interval.*
2. *The oil drain intervals are based on an engine equipped with a 14.2 liter [15 qt] capacity lubricating oil pan and a normal duty cycle. For detailed information on oil drain intervals for a specific application/duty cycle, refer to the*

Oil Drain Intervals section of this procedure.

3. *A heavy-duty extended life coolant (ELC) that meets ASTM D 6210 chemical composition specifications must be used. The change interval is 750,000 miles (1,200,000 km) or 22,000 hours onroad use (8 years or 15,000 hours off-highway use) on initial fill with no extender added. The change interval is 1,000,000 miles [1,600,000 km]/20,000 hours/8 years with an extender addition at 500,000 miles [800,000 km]/10,000 hours/4 years. Antifreeze is essential for freeze, overheat, and corrosion protection. The use of supplemental coolant additives (SCAs) is not recommended.*
4. *The aftertreatment diesel particulate filter clean/replace interval is based on the use of lubricating oils that meet the*

Cummins Engineering Standard (C.E.S.) 20081 oil specification. If a non-low ash lubricating oil meeting the American Petroleum Institute (API) performance classification CI-4/SL and/or C.E.S. 20078 is used, the service intervals for the aftertreatment systems will be reduced to 241,000 km [150,000 mi] or 5000 Hours.

5. *Follow the manufacturers' recommended maintenance procedures for the starter, alternator, batteries, electrical components, exhaust brake, charge-air cooler, radiator, air compressor, air cleaner, refrigerant compressor, and fan clutch.*

MAINTENANCE GUIDELINES

Oil Drain Intervals

The lubricating oil and lubricating oil filter interval can be adjusted based on application, fuel consumption, gross vehicle weight, and idle time.

Use the following questions to determine the maximum recommended oil change and filter change intervals in kilometers, miles, hours, or months, whichever comes first.

Is the vehicle one of those listed below?

- Emergency Vehicle
- Delivery Truck
- Fire Truck
- School Bus

If Yes, select the correct oil drain interval from Table - 1. If No, is the vehicle one of those listed below?

- Dump Truck
- Mixer Truck
- Refuse Truck

If Yes, select the correct oil drain interval from Table - 2. If No, is the vehicle one of those listed below?

- Shuttle Bus
- Transit Bus

If Yes, select the correct oil drain interval from Table - 3.

If the vehicle is a recreational vehicle or a vehicle that is not listed, select the correct oil drain interval from Table - 4.

Table - 1 Maximum Oil Drain Intervals

(A) Severe Duty (If the Vehicle Meets Any of These Conditions)	(B) Normal Duty (If the Vehicle Meets All of These Conditions)
Average fuel economy is less than 2.98 km/liter [7.0 mpg], or idle time is 40 percent or greater, or vehicle operates in dusty areas, or gross vehicle weight is greater than 20,865 kg [46,000 lbs].	Average fuel economy is greater than 2.98 km/liter [7.0 mpg], and gross vehicle weight is less than 20,865 kg [46,000 lbs].
Vehicle uses the severe-duty oil drain interval (A).	Vehicle uses the normal-duty oil drain interval (B).
14.2 liter [15 qt] oil pan: 14,500 km [9000 mi], 500 hours, 6 months, or 7571 liters [2000 US gal] of fuel, whichever occurs first.	14.2 liter [15 qt] oil pan: 24,000 km [15,000 mi], 500 hours, 6 months, or 7571 liters [2000 US gal] of fuel, whichever occurs first.

Table - 2 Oil Drain Intervals

Dump Truck, Mixer, or Refuse Truck	Kilometers	Miles	Hours	Months
Below 10 mph average	4,850	3,000	500	6
10 to 15 mph average	9,650	6,000	500	6

MAINTENANCE GUIDELINES

15 to 20 mph average	13,750	8,500	500	6
20 to 25 mph average	14,500	9,000	500	6
Above 25 mph average	19,000	12,000	500	6

Table - 3 Oil Drain Intervals

Shuttle Bus or Transit Bus	Kilometers	Miles	Hours	Months
2 to 4 mph average	2,400	1,500	500	6
4 to 6 mph average	4,850	3,000	500	6
6 to 8 mph average	6,450	4,000	500	6
8 to 10 mph average	8,050	5,000	500	6
10 to 15 mph average	9,650	6,000	500	6

Table - 4 Oil Drain Intervals

Application	Kilometers	Miles	Hours	Months
Recreation Vehicle	24,000	15,000	500	12
Truck Crane	14,500	9,000	500	6
Yard Spotter	14,500	9,000	500	6
All Others	14,500	9,000	500	6

MAINTENANCE GUIDELINES

PACCAR bases its oil drain specifications on duty cycle and oil contamination. This contamination occurs in all engines at varying rates regardless of design.

Maintaining the correct oil and filter change interval is a vital factor in preserving the integrity of an engine. Filters must be changed when the oil is changed.

Maintenance Record Form

Engine Serial No.	Engine Model:
Owner's Name:	Equipment Name/No.

Date	km [Miles], Hours, or Time Interval	Actual km [Miles] or Hours	Maintenance Check Performed	Check Performed By	Comments

Maintenance Specifications

Maintenance Specifications

General Engine Specifications

Horsepower	See engine dataplate.	
Firing Order	1-5-3-6-2-4	
Crankshaft Rotation (viewed from front of engine)	Clockwise	
Displacement	6.7 liters [409 in ³]	
Bore and Stroke	107 mm [4.21 in.] × 124 mm [4.88 in.]	
Approximate Dry Weight (without standard accessories)	522 kg [1,151 lb]	
Overhead Adjustment	Intake Valve Adjustment	0.254 mm [0.010 in.]
	Exhaust Valve Adjustment	0.660 mm [0.026 in.]
Maximum Overspeed Capability (15 seconds maximum)	4,200 rpm	
Minimum Ambient Temperature for Unaided Cold Start	-12.2°C [-10°F]	
Typical Engine Cranking Speed	120 rpm	
Engine Idle Speed	Minimum 700 rpm to maximum 900 rpm	

Lubricating Oil System

Oil Pressure	At Low Idle (minimum allowable)		69 kPa [10 psi]
	At Road Speed (minimum allowable)		207 kPa [30 psi]
Oil Regulating Valve Opening Pressure Range			448 kPa (65 psi) to 517 kPa (75 psi)
Oil Filter Differential Pressure to Open Bypass			345 kPa (50 psi)
Lubricating Oil Filter Capacity			0.950 liters (1 qt)
Lubricating Oil Capacity of Standard Engine	Standard Oil Pan	Pan Only	14.2 liters (15 qt)
		Total System	16.7 liters (17.6 qt)
		High to Low (on dipstick)	1.9 liters (2 qt)
Maximum Oil Temperature			138°C (280°F)

Maintenance Specifications

Cooling System

Coolant Capacity (engine only)	11.5 liters (3.0 gal)
Standard Modulating Thermostat Range	86 to 97°C (186 to 207°F)
Minimum Recommended Pressure Cap	103 kPa (15 psi)
Maximum Recommended Pressure Cap	172 kPa (25 psi)
Minimum Recommended Operating Temperature	71°C (160°F)
Maximum Allowed Operating Temperature	107°C (225°F)



WARNING!

Coolant is toxic. Do not get the fluid in eyes. If contact with the eyes occurs, flood eyes with large amounts of water for 15 minutes. Avoid prolonged or repeated contact with skin. In case of contact, immediately wash skin with soap and water. Do not take internally. If swallowed, seek immediate medical attention. Do not induce vomiting. Failure to comply may result in death, personal injury, equipment or property damage.



NOTE

Coolant is harmful to the environment. Unused coolant must be stored as a toxic hazardous material in leakproof containers. Used coolant must be processed as industrial chemical waste. Please follow HAZMAT guidelines with both used and unused coolants.

Filter Specifications

General Information

Fleetguard filters are standard on new PACCAR engines. PACCAR recommends their use.

Fleetguard products meet all PACCAR test standards to provide the quality filtration necessary to achieve the engine's design life. If other brands are substituted, the purchaser should ensure the filter specification meet or exceed the Fleetguard specifications.

PACCAR cannot be responsible for problems caused by non-genuine filters that do not meet PACCAR performance or durability requirements.

Filter Part Numbers	
Lubricating Oil Filter Fleetguard® Part Number	LF9104
Fuel Filter (secondary, pressure side) Fleetguard® Part Number (Square Drive Base)	FF63008
Fuel Filter (secondary, pressure side) Fleetguard® Part Number (Hex Drive Base)	FF63009
Fuel Filter (primary, suction side, with water-in-fuel sensor) Fleetguard® Part Number	FS1065
Crankcase Breather Element Fleetguard® Part Number (Rocker Lever Cover Mounted)	CV5200100
Crankcase Breather Element Fleetguard® Part Number (Rear Engine Mounted)	CV5060700
Aftertreatment DEF Dosing Unit Filter Part Number	2880298

Diesel Exhaust Fluid Recommendations and Specifications



WARNING!

It is unlawful to tamper with or remove any component of the aftertreatment system. It is also unlawful to use a Diesel Exhaust Fluid (DEF) that does not meet the specifications provided or to operate the vehicle/equipment with no Diesel Exhaust Fluid (DEF).

Maintenance Specifications



WARNING!

Diesel Exhaust Fluid (DEF) contains urea. Do not get the substance in your eyes. In case of contact, immediately flush eyes with large amounts of water for a minimum of 15 minutes. Do not swallow internally. In the event the diesel exhaust fluid is ingested, contact a physician immediately. Reference the Materials Safety Data Sheets (MSDS) for additional information. Failure to comply may result in personal injury.



CAUTION

Never attempt to create Diesel Exhaust Fluid by mixing agricultural grade urea with water. Agricultural grade urea does not meet the necessary specifications required and the aftertreatment system may be damaged. Failure to comply may result in equipment damage.



NOTE

Some locations may reference the DIN 70070 standard. Diesel Exhaust Fluid specification limits of this standard are identical to ISO 22241-1. See the Engine Aftertreatment Systems Operator's Manual for further information on Diesel Exhaust Fluid.

PACCAR Inc. is not responsible for failures or damage resulting from what PACCAR Inc. determines to be abuse or neglect, including but not limited to: operation without correctly specified Diesel Exhaust Fluid; lack of maintenance of aftertreatment; improper storage, or shutdown practices; unauthorized modifications of the engine and aftertreatment. PACCAR Inc. is also not responsible for failures caused by incorrect Diesel Exhaust Fluid or by water, dirt or other contaminants in the Diesel Exhaust

Fluid. See the Engine Aftertreatment Systems Operator's Manual for further information on Diesel Exhaust Fluid.

Fuel Recommendations



WARNING!

The use of diesel fuel that has been mixed with other fuels may cause an explosion. Do not mix gasoline, alcohol, or gasohol with diesel fuel. Make sure you know your fuel source and use the recommended diesel fuel as indicated in this section of the manual. Failure to comply may result in death, personal injury, equipment or property damage.



CAUTION

Dirt or water in the fuel system can cause severe damage to both the fuel pump and the fuel injectors. Due to the precise tolerances of diesel injection systems, it is extremely important that the fuel be kept clean and free of dirt or water. Know your fuel source and make sure all steps are taken for dispensing or using clean fuel in your vehicle. Failure to comply may result in equipment or property damage.



CAUTION

Lighter fuel can reduce economy or possibly damage fuel system components. Lighter fuels typically do not have enough lubricity elements in the fuel to properly lubricate the fuel injection system. Be sure you follow the fuel recommendations as indicated in this section of the manual. Failure to comply may result in equipment or property damage.





CAUTION

Using diesel fuels blended with lubricants may cause damage to your exhaust aftertreatment system. Service intervals for aftertreatment systems will be reduced. Do not use diesel fuel blended with lubricating oil in engines equipped with an aftertreatment system. Failure to comply may result in equipment or property damage.

Maintenance Specifications

 CAUTION
Do not use high-sulfur diesel fuel as it will damage the exhaust aftertreatment system. Also, the engine will not meet emission regulations. Use only ultra-low-sulfur diesel (ULSD) fuel. Failure to comply may result in equipment or property damage.

 CAUTION
If ultra-low-sulfur diesel fuel is not used, the engine may not meet emission regulations, and damage may occur to the exhaust aftertreatment system. The use of high-sulfur diesel fuel will damage the exhaust aftertreatment system and impact the engine emission. Ultra-low-sulfur diesel fuel is required for correct operation of the aftertreatment system. The engine has been optimized for use with an aftertreatment system to meet the 2013 U.S. Environmental Protection Agency regulations. Failure to comply may result in equipment or property damage.

 NOTE
The engine has been optimized for use with an aftertreatment system together with ULSD fuel to meet the 2013 U.S. Environmental Protection Agency (EPA) regulations.

Ultra-low sulfur diesel fuel is defined as diesel fuel not exceeding 0.0015 [15 ppm] mass percent sulfur content (ultra-low diesel fuel is also defined by ASTM S-15). There are no acceptable substitutes.

PACCAR recommends the use of ASTM number 2D fuel. The use of number 2 diesel fuel will result in optimum engine performance.

At operating temperatures below 0°C [32°F], acceptable performance can be obtained by using blends of number 2D and number 1D.

The following chart lists acceptable types of fuels for this engine.

Acceptable Types of Fuels									
Number 1D Diesel ⁽¹⁾⁽²⁾	Number 2D Diesel ⁽²⁾	Number 1K Kerosene	Jet-A	Jet-A1	JP-5	JP-8	Jet-B	JP-4	CITE
OK	OK	NOT OK	NOT OK	NOT OK	NOT OK	NOT OK	NOT OK	NOT OK	NOT OK
48-34 ⁽³⁾	40-24 ⁽³⁾	50-35 ⁽³⁾	51-37 ⁽³⁾	51-37 ⁽³⁾	48-36 ⁽³⁾	51-37 ⁽³⁾	57-45 ⁽³⁾	57-45 ⁽³⁾	57-45 ⁽³⁾

- Any adjustment to compensate for reduced performance with a fuel system using alternate fuel is not warrantable.
- Winter blend fuels, such as found at commercial fuel dispensing outlets, are combinations of number 1D and number 2D diesel fuel and are acceptable.
- BTU Content/Degree API Gravity - Low API gravity fuels have a higher thermal energy content (BTU). As a general rule, there is a 3 to 5 percent decrease in BTU content for every 10 degree increase in API gravity, there is also a 0.7 degree API gravity increase with an increase in fuel temperature. This decrease in energy content equates roughly to the same percentage of power loss. Use of fuels with higher API gravity will cause higher than normal fuel consumption.

i NOTE
 PACCAR recommends that the cetane number of diesel fuel be a minimum of 45 for engines that are expected to operate at temperatures below 0°C [32°F] and a minimum of 42 for engines that are operated at temperatures above 0°C [32°F].

i NOTE
 Using diesel fuel with a lower than recommended cetane number can cause hard starting, instability, and excessive white smoke. To maintain satisfactory operation at low ambient temperatures, it is important to specify diesel fuel of the correct cetane number.

i NOTE
 PACCAR requires all permissible fuels to have adequate fuel lubricity. This means the BOCLE number is 3100 or greater as measured by ASTM specification D6078, Scuffing Load Ball On Cylinder Evaluator (SLBOCLE). Lubricity can also be measured by ASTM, specification D6079, ISO 12156, High Frequency Reciprocating Rig (HFRR) in which the fuel must have a wear scar diameter of 0.45 mm [0.02 in] or less.



NOTE

For information on alternative fuels, such as biodiesel, and additional information for fuel recommendations and specifications, please refer to the Fuel for PACCAR Engines, Bulletin 3379001.

Warranty and the Use of Biodiesel Fuel

PACCAR Inc approves the use of biodiesel fuel blends up to 5% by volume in diesel fuel that meets all of the following three conditions:

- The biodiesel used in the blend meets ASTM Standard D 6751 or EN 14214 specifications.
- The biodiesel used in the blend is sourced from a BQ-9000 Accredited Producer.
- The finished blend meets the fuel properties of ASTM Standard D 975 or EN 590 specifications.

The use of approved biodiesel fuel does not affect the PACCAR engine warranty.

Failures caused by the use of non-approved biodiesel fuels or other fuel additives that are of unacceptable quality or do not meet specified industry standards are not considered as defects of parts or workmanship by PACCAR and therefore will not be covered by the PACCAR engine warranty.

Lubricating Oil Recommendations and Specifications

General Information

CAUTION

Extending the oil and filter change interval beyond the recommendations will decrease the engine life due to factors such as corrosion, deposits, and wear. Engine oil filters capture dirt and remove deposits from the oil to prolong the life of internal moving components. Follow the oil and filter change intervals as recommended in this section of the manual. Failure to comply may result in equipment or property damage.

The use of quality engine lubricating oils, combined with appropriate oil drain and filter change intervals, is a critical factor in maintaining engine performance and durability. Extending the oil and filter change interval beyond the recommendations will decrease engine life due to factors such as corrosion, deposits, and wear. Refer to “Oil Drain Intervals” on page 5-11 to determine which oil drain interval to use for an application.

NOTE

It is the owners responsibility to correctly follow lubricating oil recommendations. If recommendations are ignored, the engine warranty could be affected.

API: American Petroleum Institute CES: Cummins Engineering Standard

PACCAR allows, for midrange applications, the use of lubricating oils that meet or exceed CES 20078 or CES 20081 with no change in oil drain interval. But, if a non-low ash lubricating oil meeting the Cummins Engineering Standard (CES) classification CES 20078 is used, the service interval(s) for the aftertreatment system will be reduced.

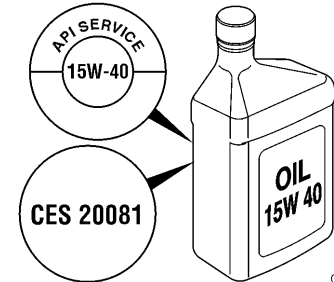

07d00259

Maintenance Specifications

To determine if the lubricating oil meets CES 20078 or CES 20081, review the label on the back of the lubricating oil bottle for the CES 20078 or CES 20081 reference. If acquiring the lubricating oil in bulk, contact the supplier for the lubricating oil specifications and confirm that the oil meets CES 20078 or CES 20081.

Also located on the lubricating oil bottle is the API service symbol which is shown in the illustration. The upper half of the symbol displays the appropriate oil categories. The center section identifies the SAE oil viscosity grade.

5

The following table shows how the Cummins Engineering Standard (CES) compares to the American Petroleum Institute (API) classification.

Cummins Engine Standard Classification (CES)	American Petroleum Institute Classification (API)	Comments
CES-20071 CES-20072 CES-20076 CES-20077	API CH-4/SJ	Not recommended. Lubricating oil drain interval must be reduced by 50%. Aftertreatment maintenance interval will be reduced.
CES-20078	CI-4/SL	Aftertreatment maintenance interval will be reduced.
CES-20081	CJ-4/SL	Maximum aftertreatment maintenance interval. No change in lubricating oil drain interval.

 NOTE
A lubricating oil that meets the American Petroleum Institute (API) performance classification CJ-4/SL may not meet the CES 20081 requirement. Always make sure the lubricating oil used meets the CES 20081 requirement in addition to the API performance classification CJ-4/SL.

PACCAR recommends the use of high-quality SAE 15W-40 heavy-duty engine oil.

The primary PACCAR recommendation is for the use of 15W- 40 multigrade lubricating oil for normal operation at ambient temperatures above -15°C [5°F]. The use of multigrade oil reduces deposit formation, improves engine cranking in low temperature conditions and increases engine durability by maintaining lubrication during high temperature operating conditions. Since multigrade oils have been shown to provide approximately 30 percent lower oil consumption compared with

monograde oils, it is important to use multigrade oils to be certain the engine will meet applicable emissions requirements.

Use of "synthetic engine oils" (those made with API group 3 or group 4 base stocks) is permitted subject to the same performance and viscosity limitations of petroleum (mineral) based engine oils. The same oil change intervals must be applied to synthetic oils that are applied to petroleum (mineral) based engine oils.

Maintenance Specifications

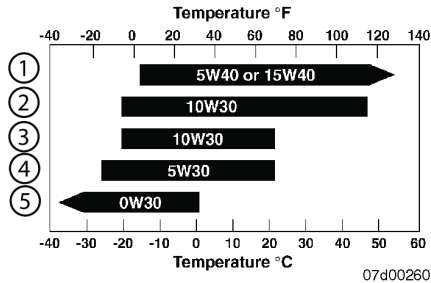

1. All Seasons
2. All Seasons
3. Winter Conditions
4. Winter Conditions
5. Arctic Conditions

5

While the preferred viscosity grade is 15W-40, lower viscosity multigrade oils can be used in colder climates. See the accompanying chart. Any viscosity grade lower than 15W-40 must still meet CES 20081.

Synthetic engine oils, API Group III and Group IV basestocks, are recommended for use in PACCAR

engines operating in ambient temperature conditions consistently below -25°C [-13°F]. Synthetic 0W-30 oils that meet the requirements of API Group III or Group IV basestocks, can be used in operations where the ambient temperature never exceeds 0°C [32°F]. Multiviscosity oils rated 0W-30 do not offer the same level of protection against fuel dilution as do higher multigrade oils. Higher cylinder wear can be experienced when using 0W-30 oils in high-load situations.

As these oils have directionally thinner oil films than 15W-40 oils, top-quality Fleetguard® filters must be used above 20°C [70°F]. Some oil suppliers might claim better fuel economy for these oils. PACCAR can neither approve nor disapprove any product not manufactured by PACCAR. These claims are between the customer and oil supplier. Obtain a commitment from the oil supplier that the oil will give

satisfactory performance in PACCAR engines or do not use the oil.

New Engine Break-In Oils

PACCAR does not approve the use of special “break-in” engine lubricating oils for new or rebuilt PACCAR engines. It is recommended to use the same lubricating oil for engine break-in that will be used during normal operation.



CAUTION

A sulfated ash limit of 1.85 percent has been placed on all engine lubricating oils recommended for use in PACCAR engines. Higher ash oils can cause valve and/or piston damage and lead to excessive oil consumption. Failure to comply may result in equipment damage.



CAUTION

The use of a synthetic-base oil does not justify extended oil change intervals. Extended oil change intervals can decrease engine life due to factors such as corrosion, deposits, and wear. Failure to comply may result in equipment damage.

Additional information regarding lubricating oil availability throughout the world is available in the EMA Lubricating Oils Data Book for Heavy-Duty Automotive and Industrial Engines. The data book can be ordered from: Engine Manufacturers Association, Two North LaSalle Street, Chicago, IL 60602; (312) 827-8733, (www.enginemanufacturers.org).

Aftermarket Oil Additive Usage

PACCAR does not recommend the use of aftermarket oil additives. Today's high-quality engine lubricating oils are very sophisticated. Most oils already contain precise amounts of additives blended into the lubricating oil to meet stringent performance requirements. These furnished oils meet performance characteristics that conform to the lubricant industry standards. Aftermarket lubricating oil additives are not necessary to enhance engine oil performance and in some cases can reduce the furnished oil's capability to protect the engine.

Maintenance Specifications

Coolant Recommendations and Specifications Fully Formulated Coolant/Antifreeze

The cooling system in your vehicle was factory filled with Extended Life Coolant (ELC) that meets or exceeds all ASTM D 6210 requirements. PACCAR recommends only using a 50/50 mixture of distilled water and ELC when cooling system service is required. A 50/50 mixture of ELC and distilled water will provide freeze protection down to -34°F [-36.7°C], which is adequate for most locations in North America. For extremely cold operating conditions, a 60/40 mixture (coolant/water ratio) can be used to provide freeze protection down to -62°F [-52.2°C].

Good-quality water is important for cooling system performance. Excessive levels of calcium and

magnesium contribute to scaling problems, and excessive levels of chlorides and sulfates cause cooling system corrosion.

Water Quality	
Calcium Magnesium (hardness)	Maximum 170 ppm as (CaCO ₃ + MgCO ₃)
Chloride	40 ppm as (Cl)
Sulfur	100 ppm as (SO ₄)

Fully formulated antifreeze must be mixed with good quality water at a 50/50 ratio (40- to 60-percent working range). A 50/50 mixture of antifreeze and water gives a -36°C [-33°F] freezing point and a 108°C [226°F] boiling point, which is adequate for locations in North America. The actual lowest freezing point of ethylene glycol antifreeze is at 68 percent. Using higher concentrations of antifreeze will raise the freezing point of the solution and increase the possibility of a silica gel problem.

PACCAR vehicle engine-cooling systems are filled with fully formulated extended-life coolant (ELC).

PACCAR recommends the use of fully formulated extended life coolant that meets the requirements of Cummins Engineering Standard (C.E. S.) 14603 for top off and service.

If the replacement coolant is Chevron Texaco, Shell Rotella or their private label counterparts which do not meet the elastomer compatibility section of CES 14603, the coolant must be treated by adding 0.24 liter [8oz] of liquid silicate fluid for every 45 liters [12 gal] of total coolant system volume. It is critical to not over treat the coolant with silicate fluid. If overtreatment is suspected, drain the cooling system and discard the filter. Clean the cooling system immediately. Symptoms of silicate over-treatment can be thickened coolant in the lower radiator tank, water pump seal leakage soon after silicate addition, reduced heater output and/or elevated engine temperatures.

To obtain order forms or ask questions relative to ordering the silicate fluid, contact:

Silicate Fluid Order Program

P.O. Box 27388
Houston, TX 77277-7388

Phone: 800-346-9041

Fax: 800-876-5317

If the replacement coolant is Chevron Texaco, Shell Rotella or their private label counterparts the coolant must be replaced with new coolant whenever the engine is overhauled or repairs involve the replacement of the following components:

- Rocker lever housing gasket.
- Lubricating oil cooler housing gasket.
- Cylinder head gasket.

- Thermostat housing gasket.

For further details of engine coolant for PACCAR PX-7 engines, refer to Cummins Coolant Requirements and Maintenance Bulletin 3666132.

Maintenance Specifications

Checking Coolant Condition

To ensure the Extended Life Coolant (ELC) in your vehicle always provides maximum freeze protection, perform the following tests:

1. Check the coolant color at every maintenance interval. It should be a bright red with no signs of debris or any oil.
2. Test the freeze point at least two times a year. A refractometer or test strips can be used to measure the protection level.
3. Keep the cooling system at full levels by topping-up using ELC pre-diluted to 50/50 blend.

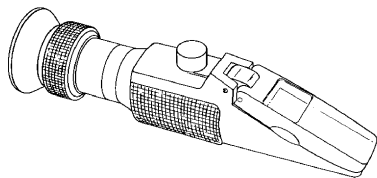



ra8toda

A refractometer must be used to measure the freezing point of the coolant accurately. Use Fleetguard® refractometer, Part Number C2800.

Recommended Extended Life Coolant Suppliers

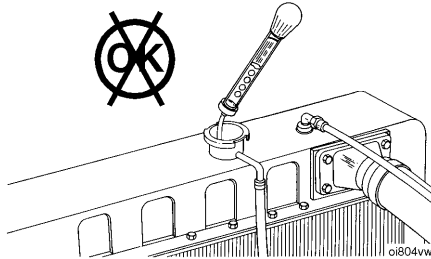
Brand Name	Supplier
TRP 	Authorized PACCAR Engine Dealer



 CAUTION
Do not use a floating ball hydrometer. The use of floating ball hydrometers can give an incorrect reading. Using a floating ball hydrometer for testing the freezing point of the coolant is an inaccurate test and will cause a false reading of the coolant freezing point. Use a refractometer to obtain an accurate test of the coolant freezing point. Failure to comply may result in equipment damage.

Cooling System Sealing Additives

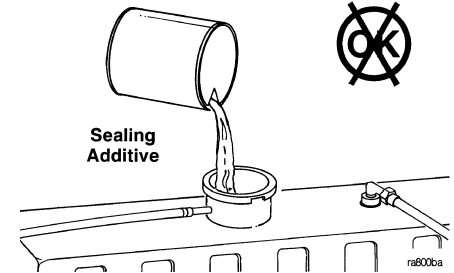

Maintenance Specifications

5



CAUTION

The use of sealing additives in the cooling system will cause damage to the engine. Sealing additives can plug various areas of the radiator, EGR system and oil cooler. The plugging of the cooling system can hamper heat transfer, causing internal engine damage. Do not use sealing additives in the cooling system. The use of sealing additives can:

- Build up in coolant low-flow areas.
- Plug the radiator and oil cooler.
- Damage the water pump seal.

Failure to comply may result in equipment damage.

Cooling System Soluble Oils

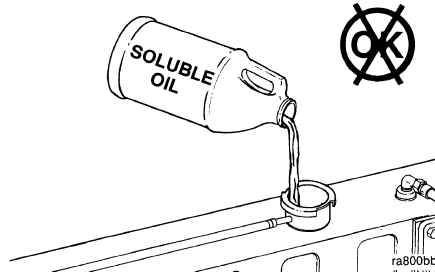

CAUTION

The use of soluble oils in the cooling system can cause damage to the engine. Soluble oils in the cooling system can:

- Damage heat transfer surfaces.
- Damage seals and hoses.
- Corrode brass and copper.

Failure to comply may result in equipment damage.

ENGINE IDENTIFICATION

Engine Dataplate 6-3
Fuel Injection Pump Dataplate 6-4
Engine Control Module Dataplate 6-5
PACCAR Engine Nomenclature. 6-5
Air Compressor. 6-6
Variable Geometry Turbocharger 6-6
PACCAR Engine Technology 6-7

Warranty

PACCAR PX-7 Engine United States and Canada
Coverage 6-8
United States and Canada Fire Apparatus Truck
Applications Coverage. 6-12
Emission Warranty 6-16
California Emission Control System Warranty,
On-Highway 6-18

ENGINE IDENTIFICATION

Engine Dataplate

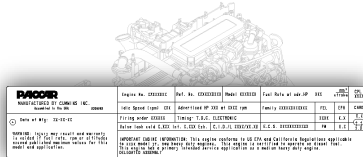

24500001

The engine dataplate provides important facts about the engine. The engine serial number (ESN) and control parts list (CPL) provide information for service and ordering parts. The engine dataplate must not be changed unless approved by PACCAR Inc.

PACCAR PX-7 MANUFACTURED BY CUMMINS INC. 5309099 Assembled in the U.S.A. Date of Mfg: XX-XX-XX WARNING: Injury may result and warranty is voided if fuel rate, rpm, or altitudes exceed published maximum values for this model and application. IMPORTANT ENGINE INFORMATION: This engine conforms to U.S. EPA and California regulations applicable to XXXX model year New Heavy Duty Engines. This engine is certified to operate on diesel fuel. This engine has a primary intended service application as a Medium Heavy Duty engine.	1	Engine No. XXXXXXXX	Ref. No. XXXXXXXX	2	Model XXXXXXX	Fuel rate at adv. HP XXX ^{mm³} / liter	XXX ^{mm³} / liter	3	CPL XXXX
	Idle Speed (rpm) XXX	Advertised HP XXX	at XXXX rpm	Family XXXXXXXXXXXXX	FEL XXX	EPA X.X	CARB X.X		
	Firing Order XXXXX	Timing / D.C. ELECTRONIC	Valve lash cold (mm) / .XXX in. X.XXX Esh.	C.I.D./L XXXX / XX.XX	E.C.S. XXXXXXXXXXXXX	PW X.X	X.X		
4	5								

The dataplate is located on rocker lever cover as illustrated.

Have the following engine data available when communicating with a PACCAR Authorized Repair Location:

1. Engine Serial Number (ESN)
2. Engine model information
3. Control Parts List (CPL)
4. Valve Lash
5. Horsepower and rpm rating

ENGINE IDENTIFICATION

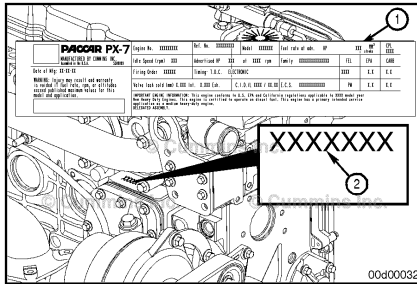

1. Dataplate
2. ESN

If the engine dataplate (1) is not readable, the ESN (2) can be found on the engine block on top of the lubricating oil cooler housing. Additional engine information is on the electronic control module (ECM) dataplate.

Fuel Injection Pump Dataplate

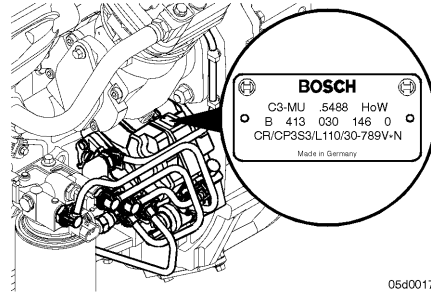

The Bosch fuel injection pump dataplate is located on the fuel pump.

The dataplate contains the following information to assist in servicing or replacement:

- Pump serial number
- PACCAR part number
- Factory code

Engine Control Module Dataplate

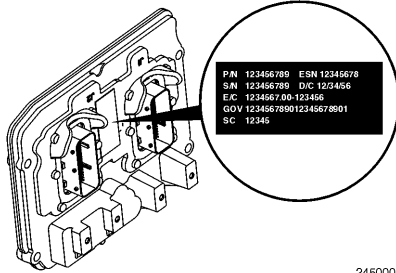

24500002

i NOTE
Not all engines have ECM dataplates.

Engines covered by this manual are equipped with a CM2350 ECM. A CM2350 ECM has two 96-pin connectors. One of the 96-pin connectors is for engine inputs and outputs. The second 96-pin connector and 14-pin connector are for

aftertreatment and vehicle inputs and outputs.

i NOTE
The presence of an ECM dataplate depends on the manufacturing plant and the date the engine was manufactured. If an ECM dataplate was not installed by the manufacturing plant, calibration data can be found on the engine dataplate.

PACCAR Engine Nomenclature

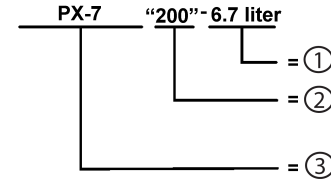

The PACCAR engine nomenclature provides the following information:

1. Displacement
2. Horsepower Rating
3. Engine Model

ENGINE IDENTIFICATION

Air Compressor

	NOTE
Not all engines are equipped with an air compressor.	

The air compressor dataplate is typically located on the side of the air compressor. The dataplate contains the following information to assist in servicing or replacement:

- Part number
- Serial number
- Date code

Variable Geometry Turbocharger

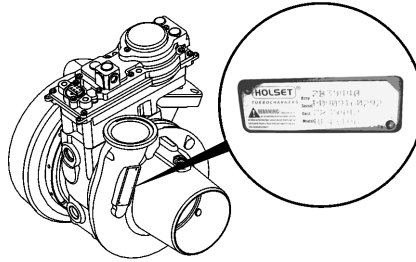

12d00095

The Holset® variable geometry turbocharger (VGT) dataplate is located on the turbocharger inlet compressor housing.

The dataplate contains the following information to assist in servicing or replacement:

- Assembly part number
- Serial number

- Customer number
- Model number.

	NOTE
The electronic actuator on the VGT is a serviceable component and has a separate dataplate that contains information to assist in servicing or replacement.	

PACCAR Engine Technology

General Information

The service model name for this product is PX-7.

This engine is being released first to meet EPA 2013.

This engine has the following Agency defined Emissions Control System (ECS) hardware:

- Charge-air cooler (CAC)
- Direct diesel injection (DDI)
- Engine control module (ECM)
- Exhaust gas recirculation (EGR)
- Oxidation catalyst (OC)
- Periodic trap oxidizer (PTOX)
- Selective catalytic reduction - urea (SCR-U)
- Turbocharger (TC).

This engine has the following emissions related hardware:

- Aftertreatment outlet NH₃ gas sensor
- CM2350 ECM
- Engine Intake Throttle Actuator
- Integrated aftertreatment DEF controller into the ECM
- Ambient Air temperature Sensor

Warranty

Warranty

PACCAR PX-7 Engine United States and Canada Coverage Products Warranted

This warranty applies to new PACCAR PX-7 Engines sold and used in the United States¹ or Canada and operated in on-highway applications with one exception - there is different warranty coverage for engines used in the fire apparatus truck applications.

The PACCAR PX-7 Engine is warranted directly to the first purchaser by PACCAR.

-
1. United States includes American Samoa, the Commonwealth of Northern Mariana Islands, Guam, Puerto Rico, and the U.S. Virgin Islands.

Base Engine Warranty

This warranty covers any failures of the Engine which result, under normal use and service, from a defect in material or factory workmanship (Warrantable Failure). This coverage begins on the date of delivery and ends two years after the date of delivery of the Engine to the first purchaser. Additional coverage is outlined in the Emission Warranty section.

Additional coverage is outlined in the Emission Warranty section.

PACCAR Responsibilities

PACCAR will pay for all parts and labor needed to repair the damage to the Engine resulting from a Warrantable Failure.

PACCAR will pay for the lubricating oil, antifreeze, filter elements, belts, hoses, and other maintenance items that are not reusable due to the Warrantable Failure. PACCAR will pay for reasonable labor costs for Engine removal and reinstallation when necessary to repair a Warrantable Failure.

PACCAR will pay for the first year from the date of delivery of the Engine to the first purchaser reasonable costs for towing a vehicle disabled by a Warrantable Failure to the nearest authorized repair station. In lieu of the towing expense and in its sole discretion, PACCAR may pay reasonable costs for a mechanic to travel to and from the location of the vehicle when an engine repair is performed at the site of the failure.

Owner Responsibilities

Owner is responsible for the operation and maintenance of the Engine as specified in the applicable PACCAR Operator's Manual. Owner is also responsible for providing proof that all recommended maintenance has been performed.

Before the expiration of the applicable warranty, Owner must notify a PACCAR authorized dealer or an authorized Cummins Distributor of any Warrantable Failure and make the engine available for repair by such facility. The Warrantable Failure must be brought to the attention of a PACCAR authorized engine dealer within 30 days of discovery. Owner must also deliver the Engine to the authorized engine repair facility during the warranty period unless deliver is impossible because the Engine has been disabled by a Warrantable failure.

Warranty

Owner is responsible for the cost of lubricating oil, antifreeze, filter elements and other maintenance items provided during warranty repairs unless such items are not reusable due to the Warrantable Failure. Owner is responsible for communication expenses, meals, lodging and similar costs incurred as a result of a Warrantable Failure.

Owner is responsible for non-Engine repairs and for "downtime" expenses, cargo damage, fines, all applicable taxes, all business costs and other losses resulting from a Warrantable Failure.

Limitations

Your sole and exclusive remedy against PACCAR and the Selling Dealer arising from your purchase and use of this Engine is limited to the repair or replacement of "warrantable failures" at authorized United States and Canadian PACCAR Engine Dealers, or an authorized Cummins Distributor, or an authorized PACCAR Engine facility where applicable, subject to PACCAR's time, mileage, and hour limitations of the engine warranty. The maximum time, mileage and hour limitations of the engine warranty begin running on the Date of Delivery to the First Purchaser. The accrued time, mileage, or hours is calculated when the engine is brought into an Authorized Dealer for correction of warrantable failures.

PACCAR is not responsible for failures or damage resulting from what PACCAR determines to be

abuse or neglect, including, but not limited to: damage due to accident; operation without adequate coolants or lubricants; overfueling; overspeeding; lack of maintenance of lubricating, cooling or intake systems; improper storage, starting, warm-up, run-in or shutdown practices; unauthorized modifications of the Engine. PACCAR is also not responsible for failures caused by incorrect oil or fuel or diesel exhaust fluid or by water, dirt or other contaminants in the fuel, oil, or diesel exhaust fluid. Failure of replacement parts used in repairs due to the above non-warrantable conditions is not warrantable.

This warranty does not apply to accessories supplied by the vehicle OEM which are covered by the OEM vehicle warranty.

Failures resulting in excessive oil consumption are covered for the duration of the coverage or 250,000

miles [402,336 kilometers] or 6,250 hours from the date of delivery of the Engine to the first purchaser, whichever of the three occurs first. Before a claim for excessive oil consumption will be considered, Owner must submit adequate documentation to show that consumption exceeds PACCAR published standards.

Failures of belts and hoses supplied by PACCAR are covered for the first year from the date of delivery of the Engine to the first purchaser.

PACCAR does not warrant antifreeze, lubricants, filters, filter elements, or any other part which is considered a maintenance item.

Parts used to repair a Warrantable Failure may be new parts, approved rebuilt parts, or repaired parts. PACCAR is not responsible for failures resulting from the use of parts not approved by PACCAR. A new

approved rebuilt part used to repair a Warrantable Failure assumes the identity of the part it replaced and is entitled to the remaining coverage hereunder.

PACCAR is not responsible for damage or loss resulting from Engine horsepower/torque upgrades.

PACCAR Inc reserves the right to interrogate Electronic Control Module (ECM) data for purposes of failure analysis.

PACCAR DOES NOT COVER WEAR OR WEAROUT OF COVERED PARTS.

THIS WARRANTY AND THE EMISSION WARRANTY SET FORTH HEREINAFTER ARE THE SOLE WARRANTIES MADE BY PACCAR IN REGARD TO THESE ENGINES.

THIS LIMITED WARRANTY IS THE SOLE WARRANTY MADE BY PACCAR AND THE SELLING DEALER. EXCEPT FOR THE ABOVE LIMITED WARRANTY, PACCAR AND THE SELLING DEALER MAKE NO OTHER WARRANTIES, EXPRESS OR IMPLIED. PACCAR AND THE SELLING DEALER EXPRESSLY DISCLAIM ANY WARRANTY OF MERCHANTABILITY OR WARRANTY OF FITNESS FOR A PARTICULAR PURPOSE.

PACCAR AND THE SELLING DEALER SHALL NOT BE LIABLE FOR INCIDENTAL OR CONSEQUENTIAL DAMAGES INCLUDING, BUT NOT LIMITED TO: LOSS OF INCOME OR LOST PROFITS; ENGINE OR VEHICLE DOWNTIME; THIRD PARTY DAMAGE, INCLUDING DAMAGE OR LOSS TO OTHER ENGINES, VEHICLES OR PROPERTY,

Warranty

ATTACHMENTS, TRAILERS AND CARGO; LOSS OR DAMAGE TO PERSONAL CONTENTS; COMMUNICATION EXPENSES; LODGING AND/OR MEAL EXPENSES; FINES; APPLICABLE TAXES OR BUSINESS COSTS OR LOSSES; ATTORNEYS' FEES; AND ANY LIABILITY YOU MAY HAVE IN RESPECT TO ANY OTHER PERSON OR ENTITY.

This warranty gives you specific legal rights, and you may also have other rights which vary from state to state.

United States and Canada Fire Apparatus Truck Applications Coverage Products Warranted

This warranty applies to new PACCAR PX-7 Engines sold and used in the United States¹ or Canada and operated in fire apparatus truck applications.

Base Engine Warranty

The Base Engine Warranty covers any failures of the Engine which result, under normal use and service, from a defect in material or factory workmanship (Warrantable Failure). This coverage begins on the date of delivery to the first purchaser and ends five years or 100,000 miles [160,935 kilometers], whichever occurs first.

Engine aftertreatment components included in the PACCAR Critical Parts List (CPL) and marked with a PACCAR part number are covered under Base Engine Warranty. Additional coverage is outlined in the Emission Warranty section.

1. United States includes American Samoa, the Commonwealth of Northern Mariana Islands, Guam, Puerto Rico, and the U.S. Virgin Islands.

PACCAR Responsibilities

PACCAR will pay for all parts and labor needed to repair the damage to the Engine resulting from a Warrantable Failure.

PACCAR will pay for the lubricating oil, antifreeze, filter elements, belts, hoses and other maintenance items that are not reusable due to the Warrantable Failure. PACCAR will pay for reasonable labor costs for Engine removal and reinstallation when necessary to repair a Warrantable Failure.

PACCAR will pay reasonable costs for towing a vehicle disabled by a Warrantable Failure to the nearest authorized repair location. In lieu of the towing expense and at its sole discretion, PACCAR will pay reasonable costs for a mechanic to travel to and from the location of

the vehicle when its engine repair is performed at the site of the failure.

Owner Responsibilities

Owner is responsible for the operation and maintenance of the Engine as specified in PACCAR Operator's Manual. Owner is also responsible for providing proof that all recommended maintenance has been performed.

Before the expiration of the applicable warranty, Owner must notify a PACCAR authorized dealer or an authorized Cummins Distributor of any Warrantable Failure and make the engine available for repair by such facility. The Warrantable Failure must be brought to the attention of a PACCAR authorized engine dealer within 30 days of discovery. Except for Engines disabled by a Warrantable Failure, Owner must also deliver the Engine to the repair facility.

Owner is responsible for the cost of lubricating oil, antifreeze, filter elements and other maintenance

Warranty

items provided during warranty repairs unless such items are not reusable due to the Warrantable Failure.

Owner is responsible for communication expenses, meals, lodging and similar costs incurred as a result of a Warrantable Failure.

Owner is responsible for non-Engine repairs and for downtime expenses, cargo damage, fines, all applicable taxes, all business costs and other losses resulting from a Warrantable Failure.

Owner is responsible for a \$100 (U.S. Dollars) deductible per each service visit under this plan in the 3rd, 4th, and 5th years of base engine warranty. The deductible will not be charged during the first two years of the base engine warranty.

Limitations

Your sole and exclusive remedy against PACCAR and the Selling Dealer arising from your purchase and use of this Engine is limited to the repair or replacement of "warrantable failures" at authorized United States and Canadian PACCAR Engine Dealers, or an authorized Cummins Distributor, or an authorized PACCAR Engine facility where applicable, subject to PACCAR's time, mileage, and hour limitations of the engine warranty. The maximum time, mileage and hour limitations of the engine warranty begin running on the Date of Delivery to the First Purchaser. The accrued time, mileage, or hours is calculated when the engine is brought into an Authorized Dealer for correction of warrantable failures.

PACCAR is not responsible for failures or damage resulting from what PACCAR determines to be

abuse or neglect, including but not limited to: damage due to accident; operation without adequate coolants or lubricants; overfueling; overspeeding; lack of maintenance of lubricating, cooling or intake systems; improper storage, starting, warm-up, run-in or shutdown practices; unauthorized modifications of the Engine. PACCAR is also not responsible for failures caused by incorrect oil, fuel or diesel exhaust fluid or by water, dirt or other contaminants in the fuel, oil or diesel exhaust fluid. Failure of replacement parts used in repairs due to the above non-warrantable conditions is not warrantable.

This warranty does not apply to accessories supplied by PACCAR which are covered by the OEM vehicle warranty.

Failures resulting in excessive oil consumption are not covered beyond the duration of the coverage or 100,000

miles [160,935 kilometers] or 6,250 hours from the date of delivery of the Engine to the first purchaser, whichever of the three occurs first. Before a claim for excessive oil consumption will be considered, Owner must submit adequate documentation to show that consumption exceeds PACCAR published standards.

Failures of belts and hoses supplied by PACCAR are not covered beyond the first year from the date of delivery of the Engine to the first purchaser.

PACCAR does not warranty antifreeze, lubricants, filters, filter elements, or any other part which is considered a maintenance item.

Parts used to repair a Warrantable Failure may be new parts, approved rebuilt parts, or repaired parts. PACCAR is not responsible for failures resulting from the use of parts not approved by PACCAR. A new or

approved rebuilt part used to repair a Warrantable Failure assumes the identity of the part it replaced and is entitled to the remaining coverage hereunder.

PACCAR is not responsible for damage or loss resulting from Engine horsepower/torque upgrades.

PACCAR reserves the right to interrogate Electronic Control Module (ECM) data for purposes of failure analysis.

PACCAR DOES NOT COVER WEAR OR WEAROUT OF COVERED PARTS.

THIS WARRANTY AND THE EMISSION WARRANTY SET FORTH HEREINAFTER ARE THE SOLE WARRANTIES MADE BY PACCAR IN REGARD TO THESE ENGINES.

THIS LIMITED WARRANTY IS THE SOLE WARRANTY MADE BY PACCAR AND THE SELLING DEALER. EXCEPT FOR THE ABOVE LIMITED WARRANTY, PACCAR AND THE SELLING DEALER MAKE NO OTHER WARRANTIES, EXPRESS OR IMPLIED. PACCAR AND THE SELLING DEALER EXPRESSLY DISCLAIM ANY WARRANTY OF MERCHANTABILITY OR WARRANTY OF FITNESS FOR A PARTICULAR PURPOSE.

PACCAR AND THE SELLING DEALER SHALL NOT BE LIABLE FOR INCIDENTAL OR CONSEQUENTIAL DAMAGES INCLUDING, BUT NOT LIMITED TO: LOSS OF INCOME OR LOST PROFITS; ENGINE OR VEHICLE DOWNTIME; THIRD PARTY DAMAGE, INCLUDING DAMAGE OR LOSS TO OTHER ENGINES, VEHICLES OR PROPERTY,

Warranty

ATTACHMENTS, TRAILERS AND CARGO; LOSS OR DAMAGE TO PERSONAL CONTENTS; COMMUNICATION EXPENSES; LODGING AND/OR MEAL EXPENSES; FINES; APPLICABLE TAXES OR BUSINESS COSTS OR LOSSES; ATTORNEYS' FEES; AND ANY LIABILITY YOU MAY HAVE IN RESPECT TO ANY OTHER PERSON OR ENTITY.

This warranty gives you specific legal rights, and you may also have other rights which vary from state to state.

Emission Warranty

Products Warranted

This emission warranty applies to new PACCAR Engines marketed by PACCAR that are used in the United States¹ in vehicles designed for transporting persons or property on a street or highway.

Coverage

PACCAR warrants to the first purchaser and each subsequent purchaser that the Engine is designed, built and equipped so as to conform at the time of sale by PACCAR with all U.S. Federal emission regulations applicable at the time of manufacture and that it is free from defects in material or factory workmanship which would cause it not to meet these regulations within the longer of the following periods: (A) Five years or 100,000 miles [160,935 kilometers] of operation, whichever occurs first, as measured from the date of delivery of the Engine to the first purchaser or (B) The Base Engine Warranty.

If the vehicle in which the Engine is installed is registered in the state of California, a separate California Emission Warranty also applies.

1. United States includes American Samoa, the Commonwealth of Northern Mariana Islands, Guam, Puerto Rico, and the U.S. Virgin Islands.

Replacement Parts

PACCAR recommends that any service parts used for maintenance, repair or replacement of emission control systems be new or genuine approved rebuilt parts and assemblies, and that the engine be serviced by an authorized PACCAR Engine dealer or an authorized Cummins Distributor. Your vehicle contains air, fuel, and electrical components that may affect engine emission controls. The use of non-genuine engine or vehicle replacement parts that are not equivalent to the PACCAR engine or OEM vehicle manufacturer's original part may impair the engine and vehicle emissions control system from working or functioning effectively, and may jeopardize your emissions warranty coverage.

Limitations

Your sole and exclusive remedy against PACCAR and the Selling Dealer arising from your purchase and use of this Engine is limited to the repair or replacement of "warrantable failures" at authorized United States and Canadian PACCAR Engine Dealers, or an authorized Cummins Distributor, or an authorized PACCAR Engine facility where applicable, subject to PACCAR's time, mileage, and hour limitations of the engine emission warranty. The maximum time, mileage and hour limitations of the engine emission warranty begin running on the Date of Delivery to the First Purchaser. The accrued time, mileage, or hours is calculated when the engine is brought into an Authorized Dealer for correction of warrantable failures.

Failures, other than those resulting from defects in material or factory

workmanship, are not covered by this Warranty. PACCAR is not responsible for failures or damage resulting from what PACCAR determines to be abuse or neglect, including, but not limited to: damage due to accident; operation without adequate coolants or lubricants; overfueling; overspeeding; lack of maintenance of lubricating, cooling or intake systems; improper storage, starting, warm-up, run-in or shutdown practices; unauthorized modifications of the Engine. PACCAR is also not responsible for failures caused by incorrect oil, fuel or diesel exhaust fluid or by water, dirt or other contaminants in the fuel, oil or diesel exhaust fluid. Failure of replacement parts used in repairs due to the above non-warrantable conditions is not warrantable.

PACCAR is not responsible for non-Engine repairs, downtime expenses, cargo damage, fines, all applicable taxes, all business costs

Warranty

or other losses resulting from a Warrantable Failure.

THIS LIMITED EMISSION WARRANTY IS THE SOLE WARRANTY MADE BY PACCAR RELATING TO THE EMISSION EQUIPMENT. EXCEPT FOR THE ABOVE LIMITED WARRANTY, PACCAR MAKES NO OTHER WARRANTIES, EXPRESS OR IMPLIED. PACCAR EXPRESSLY DISCLAIMS ANY WARRANTY OF MERCHANTABILITY OR WARRANTY OF FITNESS FOR A PARTICULAR PURPOSE.

PACCAR AND THE SELLING DEALER SHALL NOT BE LIABLE FOR INCIDENTAL OR CONSEQUENTIAL DAMAGES INCLUDING, BUT NOT LIMITED TO: LOSS OF INCOME OR LOST PROFITS; ENGINE OR VEHICLE DOWNTIME; THIRD PARTY DAMAGE, INCLUDING DAMAGE

OR LOSS TO OTHER ENGINES, VEHICLES OR PROPERTY, ATTACHMENTS, TRAILERS AND CARGO; LOSS OR DAMAGE TO PERSONAL CONTENTS; COMMUNICATION EXPENSES; LODGING AND/OR MEAL EXPENSES; FINES; APPLICABLE TAXES OR BUSINESS COSTS OR LOSSES; ATTORNEYS' FEES; AND ANY LIABILITY YOU MAY HAVE IN RESPECT TO ANY OTHER PERSON OR ENTITY.

California Emission Control System Warranty, On-Highway Products Warranted

This Emission Control System Warranty applies to diesel engines (hereafter, engines) certified with the California Air Resources Board beginning with the year 2009, marketed by PACCAR, and registered in California for use in on-highway applications.

Your Warranty Rights and Obligations

The California Air Resources Board and PACCAR Inc are pleased to explain the emission control system warranty on your 2009 and subsequent model year diesel engine. In California, new motor vehicle engines must be designed, built and equipped to meet the State's stringent anti-smog standards. PACCAR must warranty the emission control system on your diesel engine for the periods of time listed below provided there has been no abuse, neglect or improper maintenance of your diesel engine.

Your emission control system may include parts such as the fuel injection system and engine electronic control module. Also included may be hoses, connectors and other emission related assemblies.

If an emission-related part on your engine is found to have a defect in material or factory the part will be repaired or replaced by PACCAR. This is your emission control system defects warranty.

Manufacturer's Warranty Coverage

This warranty coverage is provided for five years or 100,000 miles [160,935 km] or 3,000 hours of engine operation, whichever first occurs from the date of delivery of the engine to the first purchaser. Where a Warrantable Condition exists, PACCAR will repair your engine at no cost to you including diagnosis, parts and labor.

Warranty

Owner's Warranty Responsibilities

As the engine owner, you are responsible for the performance of the required maintenance listed in your PACCAR Operator's Manual. You are responsible for presenting your engine to an authorized PACCAR Dealer or an authorized Cummins Distributor as soon as a problem exists. The warranty repairs should be completed in a reasonable amount of time, not to exceed 30 days.

PACCAR recommends that you retain all receipts covering maintenance on your engine, but PACCAR cannot deny warranty solely for the lack of receipts or for the failure to ensure the performance of all scheduled maintenance.

As the engine owner, you should also be aware that PACCAR may deny you warranty coverage if your engine or a part has failed due to abuse, neglect, improper maintenance or unapproved modifications.

If you have any questions regarding your warranty rights and responsibilities, you should contact the vehicle OEM manufacturer at the customer center telephone number provided with your vehicle operating instructions or the California Air Resource Board at 9528 Telstar Avenue, El Monte, CA 91731.

A warranted part which is scheduled for replacement as required maintenance is warranted up to the first scheduled replacement point.

Prior to the expiration of the applicable warranty, Owner must give notice of any warranted emission control failure to an authorized PACCAR Engine dealer and deliver the engine to such facility for repair.

Owner is responsible for incidental costs such as: communication expenses, meals, lodging incurred by Owner or employees of Owner as a result of a Warrantable Condition.

Owner is responsible for downtime expenses, cargo damage, fines, all applicable taxes, all business costs, and other losses resulting from a Warrantable Condition.

California Emissions Components Statement for the PX-7 Engine (2013) Emission Engine Coverage

This list of emission control parts may be covered by the Emission Control System Warranty under certain failure modes.

Aftertreatment System

- Aftertreatment Electroconnections
- Aftertreatment Inlet and Outlet Modules
- Aftertreatment Temperature Interface Module
- Aftertreatment Temperature Sensors
- Decomposition Tube
- Diesel Exhaust Fluid (DEF) Dosing Unit (Pump)
- DEF Dosing Valve
- DEF Level Sensor
- DEF Line Heater Control Relay
- DEF Quality Sensor
- DEF Tank Heater Coolant Control Valve
- DEF Tank and Lines
- DEF Tank/Lines Heating Elements of Heat Exchanger and Pipe
- DEF Temperature Sensors
- Diesel Oxidation Catalyst
- Diesel Particulate Filter (except for ash maintenance)
- Diesel Particulate Filter Differential Pressure Sensor EGR
- NH3 Sensor
- NOx Sensors
- SCR Catalyst

Warranty

- Exhaust Gas Piping from Turbocharger out to the Last Aftertreatment Device

Air Handling Component

- Ambient Air Temperature Sensor
- Charge Air Cooler and Associated Plumbing
- Exhaust Gas Pressure Sensor
- Exhaust Manifold
- Grid Heater
- Intake Manifold
- Intake Manifold Temperature/Pressure Sensor
- Throttle Actuator/Valve
- Turbocharger Actuator
- Turbocharger Assembly
- Turbocharger Compressor Intake Pressure/Temperature Sensor

- Turbocharger Speed Sensor

Base Engine System Component

- Camshaft
- Camshaft Valve Lobe
- Clean Idle Sticker
- Coolant Temperature Sensor
- Crankcase Breather
- Engine Oil Pressure Sensor
- Engine Speed, Position Sensor, Cam Position Sensor
- Exhaust Valve

Electronic Control System Component

- Engine Control Module
- Wiring Harness Circuits Connected at Both Ends to Emissions Warrantable Components

- Engine Control Module Calibration
- DEF Lamp
- On Board Diagnostic (OBD) Malfunction Indicator Lamp (MIL)
- OBD Connector

Exhaust Gas Recirculation (EGR) System Component

- EGR Cooler
- EGR Differential Pressure Sensor
- EGR Mixer/Venturi
- EGR Temperature Sensor
- EGR Valve

Fueling System

- Fuel Injectors
- Fuel Lines
- Fuel Pressure Sensor

- Fuel Pump Actuator
- Fuel Pump
- Secondary Fuel Pressure/Temperature Sensor

Replacement Parts

PACCAR recommends that any service parts used for maintenance, repair or replacement of emission control systems be new or genuine approved rebuilt parts and assemblies, and that the engine be serviced by an authorized PACCAR Engine dealer or an authorized Cummins Distributor. Your vehicle contains air, fuel, and electrical components that may affect engine emission controls. The use of non-genuine engine or vehicle replacement parts that are not equivalent to the PACCAR engine or OEM vehicle manufacturer's original part may impair the engine and vehicle emissions control system from working or functioning effectively, and may jeopardize your emissions warranty coverage.

The owner may elect to have maintenance, replacement or repair of the emission control parts performed by a facility other than a PACCAR authorized dealer or an authorized Cummins Distributor and may elect to use parts other than new genuine approved rebuilt parts and assemblies for such maintenance, replacement or repair; however, the cost of such service or parts and subsequent failures resulting from such service or parts will not be covered under this emission control system warranty, except for Emergency Repairs as described below.

Warranty

PACCAR Responsibilities

The warranty coverage begins when the engine is delivered to the first purchaser. Repairs and service will be performed by any authorized PACCAR Engine, dealer or an authorized Cummins Distributor using new or genuine approved rebuilt parts and assemblies. PACCAR will repair any of the emission control parts found by PACCAR to be defective without charge for parts or labor (including diagnosis which results in determination that there has been a failure of a warranted emission control part).

Emergency Repairs

In the case of an emergency where an authorized PACCAR Engine dealer or an authorized Cummins Distributor is not available, repairs may be performed by any available repair location or by any individual using any replacement parts. A part not being available within 30 days or a repair not being complete within 30 days constitutes an emergency. PACCAR will reimburse the Owner for expenses (including diagnosis), not to exceed the manufacturer's suggested retail price for all warranted parts replaced and labor charges based on the manufacturer's recommended time allowance for the warranty repair and the geographically appropriate hourly labor rate.

Replaced parts and paid invoices must be presented at an authorized PACCAR Engine dealer or authorized Cummins Distributor as a condition of reimbursement for emergency repairs not performed by an authorized PACCAR Engine dealer or an authorized Cummins Distributor.

Warranty Limitations

Your sole and exclusive remedy against PACCAR and the Selling Dealer arising from your purchase and use of this Engine is limited to the repair or replacement of "warrantable failures" at authorized United States and Canadian PACCAR Engine Dealers, or an authorized PACCAR Engine facility where applicable, subject to PACCAR's time, mileage, and hour limitations of the engine emission warranty. The maximum time, mileage and hour limitations of the engine emission warranty begin running on the Date of Delivery to the First Purchaser. The accrued time, mileage, or hours is calculated when the engine is brought into an Authorized Dealer for correction of warrantable failures.

PACCAR is not responsible for failures or damage resulting from what PACCAR determines to be

abuse or neglect, including, but not limited to: damage due to accident; operation without adequate coolants or lubricants; overfueling; overspeeding; lack of maintenance of cooling, lubricating or intake systems; improper storage, starting, warm-up, run-in or shutdown practices; unauthorized modifications to the engine. PACCAR is also not responsible for failures caused by incorrect oil, fuel or diesel exhaust fluid or by water, dirt or other contaminants in the fuel, oil or diesel exhaust fluid. Failure of replacement parts used in repairs due to the above non-warrantable conditions is not warrantable.

PACCAR is not responsible for failures resulting from improper repair or the use of parts which are not genuine approved parts.

PACCAR is not responsible for the material and labor costs of emission control parts and assemblies replaced

during Scheduled Maintenance of the engine as specified in PACCAR Operator's Manuals.

THIS WARRANTY, TOGETHER WITH THE EXPRESS COMMERCIAL WARRANTIES MADE BY PACCAR IN REGARD TO THESE ENGINES.

THIS LIMITED EMISSIONS WARRANTY IS THE SOLE WARRANTY MADE BY PACCAR AND THE SELLING DEALER. EXCEPT FOR THE ABOVE LIMITED WARRANTY, PACCAR AND THE SELLING DEALER MAKE NO OTHER WARRANTIES, EXPRESS OR IMPLIED. PACCAR AND THE SELLING DEALER EXPRESSLY DISCLAIM ANY WARRANTY OF MERCHANTABILITY OR WARRANTY OF FITNESS FOR A PARTICULAR PURPOSE.

Warranty

PACCAR AND THE SELLING DEALER SHALL NOT BE LIABLE FOR INCIDENTAL OR CONSEQUENTIAL DAMAGES INCLUDING, BUT NOT LIMITED TO: LOSS OF INCOME OR LOST PROFITS; ENGINE OR VEHICLE DOWNTIME; THIRD PARTY DAMAGE, INCLUDING DAMAGE OR LOSS TO OTHER ENGINES, VEHICLES OR PROPERTY, ATTACHMENTS, TRAILERS AND CARGO; LOSS OR DAMAGE TO PERSONAL CONTENTS; COMMUNICATION EXPENSES; LODGING AND/OR MEAL EXPENSES; FINES; APPLICABLE TAXES OR BUSINESS COSTS OR LOSSES; ATTORNEYS' FEES; AND ANY LIABILITY YOU MAY HAVE IN RESPECT TO ANY OTHER PERSON OR ENTITY.

Index

- A**
Acronyms and abbreviations 1-12
Aftermarket Oil Additive Usage 5-29
Air compressor 6-6
- C**
California Emission Control System
Warranty, On-Highway 6-18
California Emissions Components
Statement for the PX-7 Engine (2013)
Emission Engine Coverage 6-21
Check Engine Lamp 3-4
Check Engine Lamp Turns On 2-5
Checking Coolant Condition 5-32
Cold Weather Operating Aids 4-14
Cold Weather Starting
starting aids 4-9
Coolant Recommendations and
Specifications 5-30
checking coolant condition 5-32
cooling system sealing
additives 5-33
cooling system soluble oils 5-34
recommended extended life coolant
suppliers 5-33
Cooling System 5-18
Cooling System Sealing
Additives 5-33
Cooling System Soluble Oils 5-34
- D**
Diesel Exhaust Fluid (DEF) Lamp 3-6
Diesel Exhaust Fluid
Recommendations and
Specifications 5-19
Diesel Particulate Filter (DPF) Warning
Lamp 3-5
Driving Tips
operation on grades with dry
pavement 4-18
operation on level and dry
pavement 4-17
operation on slick roads 4-20
- E**
Electromagnetic Interference
(EMI) 4-15
general information 4-15
system EMI radiation levels 4-16
system EMI susceptibility 4-16
Emission Warranty 6-16
Engine Braking System
variable geometry turbo (VGT)
brake 3-8
Engine Control Module Dataplate 6-5
Engine Control Module Identification
engine control module
dataplate 6-5
Engine Dataplate 6-3
Engine Identification
engine dataplate 6-3

Index

PACCAR engine nomenclature 6-5
Engine is Overheating 2-5
Engine Oil Pressure Lamp Turns
On 2-4
Engine Operating Range 3-7
 general information 3-7
Engine Overheating 4-10
Engine Shutdown 4-15
 before stopping the engine 4-15
Engine Warning Lamps 3-3
 check engine lamp 3-4
 diesel exhaust fluid (DEF) lamp 3-6
 diesel particulate filter (DPF)
 warning lamp 3-5
 general information 3-3
 high exhaust system temperature
 (HEST) warning lamp 3-5
 malfunction indicator lamp 3-4
 stop engine lamp 3-5
 wait-to-start lamp 3-3

F

Filter Specifications
 general information 5-19
Foreword 1-6

Fuel Injection Pump Dataplate 6-4
Fuel Injection Pump Identification
 fuel injection pump dataplate 6-4
Fuel Recommendations 5-21

G

General Engine Specifications 5-16
General Safety Instructions 1-9

H

High Exhaust System Temperature
(HEST) Warning Lamp 3-5

I

Illustrations 1-5
Important Reference Numbers 1-7

L

Lamp
 high exhaust system temperature
 (HEST) warning 3-5
Lubricating Oil Recommendations and
Specifications
 general information 5-25

Lubricating Oil System 5-17

M

Maintenance Guidelines
 general information 5-3
Maintenance Record Form 5-15
Maintenance Schedule
 125,000 km / 2,500 hours 5-8
 15,000 mi / 500 hours or 6
 months 5-6
 150,000 mi / 5,000 hours 5-8
 200,000 mi / 6500 hours 5-8
 30,000 mi / 1,000 hours or 12
 months 5-6
 60,000 mi / 2,000 hours 5-7
 60,000 mi / 2,000 hours or 2
 years 5-7
 7,500 mi / 250 hours, or 3
 months 5-5
 750,000 mi / 22,000 hours 5-9
 daily or refueling – maintenance
 check 5-4
 general information 5-3
 maintenance record form 5-15
 maximum oil drain intervals 5-11

oil drain intervals 5-10
Maintenance Specifications
 acceptable types of fuels 5-22
 aftermarket oil additive usage 5-29
 API: American Petroleum
 Institute 5-25
 CES: Cummins Engineering
 Standard 5-25
 checking coolant condition 5-32
 coolant recommendations and
 specifications 5-30
 cooling system 5-18
 cooling system sealing
 additives 5-33
 cooling system soluble oils 5-34
 diesel exhaust fluid
 recommendations and
 specifications 5-19
 engine specifications 5-16
 filter specifications 5-19
 fuel recommendations and
 specifications 5-21
 lubricating oil recommendations
 and specifications 5-25
 lubricating oil system 5-17
 new engine break-in oils 5-29

recommended extended life coolant
suppliers 5-33
warranty and the use of biodiesel
fuel 5-24
Malfunction Indicator Lamp 3-4
Maximum Oil Drain Intervals 5-11

N

New Engine Break-In Oils 5-29
Normal Starting Procedure 4-4

O

Oil Drain Intervals 5-10
On-Board Diagnostics
 unique operating characteristics
 of an engine with on-board
 diagnostics 1-13
Operating Instructions
 cold weather starting 4-9
 general information 4-3
 normal starting procedure 4-4
 operating the engine 4-10
 starting procedure after extended
 shutdown or oil change 4-9
Operating the Engine

cold weather 4-13
cold weather operating aids 4-14
coolant 4-13
engine overheating 4-10
normal 4-10

P

PACCAR Engine Nomenclature 6-5
PACCAR Engine Technology 6-7
PACCAR PX-7 Engine United States
and Canada Coverage 6-8

R

Recommended Extended Life Coolant
Suppliers 5-33

S

Safety
 general safety instructions 1-9
 illustrations 1-5
 safety alerts 1-3
Starting Procedure After Extended
Shutdown or Oil Change 4-9
Stop Engine Lamp 3-5

Index

Stop Engine Lamp Turns On 2-3

U

Unique Operating Characteristics
of an Engine with On-Board
Diagnostics 1-13
United States and Canada Fire
Apparatus Truck Applications
Coverage 6-12

V

Variable Geometry Turbo (VGT) Brake
System General Information 3-8
Variable Geometry Turbocharger 6-6

W

Wait-to-Start Lamp 3-3

Warranty

California emission control system
warranty - on-highway 6-18
California emissions components
statement for the PX-7 engine 6-21
emission warranty 6-16

PACCAR PX-7 engine United
States and Canada coverage 6-8
United States and Canada fire
apparatus truck applications
coverage 6-12

Warranty and the Use of Biodiesel
Fuel 5-24

What to do if... 2-3

check engine lamp turns on 2-5
engine is overheating 2-5
engine oil pressure lamp turns
on 2-4
stop engine lamp turns on 2-3
you need roadside assistance 2-3

PACCAR^{Inc}
Medium Duty Engines
P.O. Box 1518
Bellevue, WA 98009

Y53-1183-1A1