

Use and maintenance manual

John Deere Electronically - Controlled POWERTECH 4.5 L & 6.8 L 4045 and 6068 OEM Diesel Engines

CALIFORNIA

Proposition 65 Warning

Diesel engine exhaust and some of its constituents are known to the State of California to cause cancer, birth defects, and other reproductive harm.

If this product contains a gasoline engine:



WARNING

The engine exhaust from this product contains chemicals known to the State of California to cause cancer, birth defects or other reproductive harm.

The State of California requires the above two warnings.

Réf. constructeur : OMRG33324

Réf. GPAO : 33522045801 ind2



Danger

Warning about the dangers linked to fuel discharges under high pressure on engines equipped with Denso high pressure common rail (HPCR).

- Watch out for fuel under high pressure throughout the system
- Never dismantle the fuel lines, when the engine is running (lines under high pressure)
- It is better to work on the injection system when the fuel temperature is less than 30°C
- Wait at least 5 minutes after the engine stops before carrying out work on the injection system (check the pressure before doing anything)
- After changing the component, check that there are no fuel leaks. Carry out this test with the engine protection closed (engine bonnet or other protection)
- Do not dismantle and reassemble the injector parts

Introduction

Foreword

THIS MANUAL CONTAINS INFORMATION to operate and service the following **Tier 2** emission-certified¹ engines:

Saran-built (France) Tier 2 Mechanically Controlled Engines:

- CD4045DF270
- CD4045TF270

Saran-built (France) Tier 2 Electronically Controlled Engines:

- CD4045TF275 (DE10 Fuel System)
- CD4045HF275 (DE10 Fuel System)
- CD4045HF475 (HPCR System; 4-Valve Head)
- CD6068TF275 (DE10 Fuel System)
- CD6068HF275 (DE10/VP44 Fuel System)
- CD6068HF475 (HPCR System; 4-Valve Head)

Torreon-built (Mexico) Tier 2 Mechanically Controlled Engines:

- PE4045DF270
- PE4045TF270

Torreon-built (Mexico) Tier 2 Electronically Controlled Engines:

- PE4045TF275 (DE10 Fuel System)
- PE4045HF275 (DE10 Fuel System)
- PE4045HF475 (HPCR System; 4-Valve Head)
- PE6068TF275 (DE10 Fuel System)
- PE6068HF275 (DE10/VP44 Fuel System)

- PE6068HF475 (HPCR System; 4-Valve Head)

READ THIS MANUAL carefully to learn how to operate and service your engine correctly. Failure to do so could result in personal injury or equipment damage.

THIS MANUAL SHOULD BE CONSIDERED a permanent part of your engine and should remain with the engine when you sell it.

MEASUREMENTS IN THIS MANUAL are given in both metric and customary U.S. unit equivalents. Use only correct replacement parts and fasteners. Metric and inch fasteners may require a specific metric or inch wrench.

WRITE ENGINE SERIAL NUMBERS and option codes in the spaces indicated in the Record Keeping Section. Accurately record all the numbers. Your dealer also needs these numbers when you order parts. File the identification numbers in a secure place off the engine.

SETTING FUEL DELIVERY beyond published factory specifications or otherwise overpowering will result in loss of warranty protection for this engine.

CERTAIN ENGINE ACCESSORIES such as radiator, air cleaner, and instruments are optional equipment on John Deere OEM Engines. These accessories may be provided by the equipment manufacturer instead of John Deere. This operator's manual applies only to the engine and those options available through the John Deere distribution network.

¹Emission certified for United States as EPA Tier 2 and for European Union as Stage II.

IMPORTANT: This manual covers only *POWERTECH*[™] Tier 2 emission certified 4.5 and 6.8 L OEM engines listed. These engines meet Tier 2 emission certification standards.² (This is for both the U.S. EPA and European Union Council (EU) standards.) Engines with mechanical controls which are non-emission certified or Tier 1 emission certified (U.S. and

EU) are covered in a separate operators manual, OMRG25204.

NOTE: This manual covers engines provided to OEM (Outside Equipment Manufacturers). For engines in Deere machines, refer to the machine operator's manual. All Tier 2 engines built in Saran (CD prefix) are serial number (800,000 -)

²Two exceptions: The 4045HF475 and 6068HF475 for generator applications at 1500 rpm are still emission non-certified.

Engine Owner

John Deere Engine Owner:

Don't wait until you need warranty or other service to meet your local John Deere Engine Distributor or Service Dealer. To register your engine for warranty via the Internet, use the following URL:

<http://www.johndeere.com/enginewarranty>

Learn who your dealer is and where he is. At your first convenience, go meet him. He'll want to get to know you and to learn what your needs might be.

Aux Utilisateurs De Moteurs John Deere:

N'attendez pas d'être obligé d'avoir recours à votre concessionnaire John Deere ou au point de service le plus proche pour vous adresser à lui. Pour enregistrer votre moteur pour la garantie via Internet, utilisez l'adresse suivante:

<http://www.johndeere.com/enginewarranty>

Renseignez-vous dès que possible pour l'identifier et le localiser. A la première occasion, prenez contact avec lui et faites-vous connaître. Il sera lui aussi heureux de faire votre connaissance et de vous proposer ses services le moment venu.

An Den Besitzer Des John Deere Motors:

Warten Sie nicht auf einen evt. Reparaturfall, um den nächstgelegenen John Deere Händler kennen zu lernen. Zur Registrierung Ihres Motors für die Garantie dient folgende Internet-Adresse:

<http://www.johndeere.com/enginewarranty>

Machen Sie sich bei ihm bekannt und nutzen Sie sein "Service Angebot".

Proprietario del motore John Deere:

Non aspetti fino al momento di far valere la garanzia o di chiedere assistenza per fare la conoscenza del

distributore dei motori John Deere o del concessionario che fornisce l'assistenza tecnica. Per registrare via Internet la garanzia del suo motore, si colli al seguente sito URL:

<http://www.johndeere.com/enginewarranty>

Lo identifichi e si informi sulla sua ubicazione. Alla prima occasione utile lo contatti. Egli desidera fare la sua conoscenza e capire quali potrebbero essere le sue necessità.

Propietario De Equipo John Deere:

No espere hasta necesitar servicio de garantía o de otro tipo para conocer a su Distribuidor de Motores John Deere o al Concesionario de Servicio. Registre su motor para la garantía en la siguiente dirección de internet: <http://www.johndeere.com/enginewarranty>

Entérese de quién es, y dónde está situado. Cuando tenga un momento, vaya a visitarlo. A él le gustará conocerlo, y saber cuáles podrían ser sus necesidades.

Till ägare av John Deere motorer:

Ta reda på vem din återförsäljare är och besök honom så snart tillfälle ges. Vänta inte tills det är dags för service eller eventuellt garantiarbete. Din motor garantiregistrerar Du via Internet på <http://www.johndeere.com/enginewarranty>

Din återförsäljare vill mycket gärna träffa dig för att lära känna dina behov och hur bäst han kan hjälpa dig.

**POWERTECH™ 4.5 L Engines With Electronic Fuel Systems (Tier 2 Emission Certified)
(Two-Valve Cylinder Head Models)**



4045 Engine (Stanadyne DE10 Injection Pump Shown)

RG11931 -JUN-06NOV01



4045 Engine

RG11932 -JUN-06NOV01

POWERTECH is a trademark of Deere & Company

OUOD002,0000162 -19-25FEB03-1/1

**POWERTECH™ 6.8 L Engines With Electronic Fuel Systems (Tier 2 Emission Certified)
(Two-Valve Cylinder Head Models)**



6068 Engine (Bosch VP44 Injection Pump Shown)

RG11933 -JUN-24OCT01



6068 Engine

RG11934 -JUN-24OCT01

POWERTECH is a trademark of Deere & Company

OUOD002,0000163 -19-25FEB03-1/1

**POWERTECH™ 4.5/6.8 L Engines With Electronic Fuel Systems (Tier 2 Emission Certified)
(Four-Valve Cylinder Head “475” Models)**



RG12199 -JUN-24MAY02

6068HF475 Engine Shown (Level 11 Electronic Fuel System With Denso High Pressure Common Rail)



RG12200 -JUN-24MAY02

6068HF475 Shown

Contents

	Page		Page
Record Keeping		Viewing Engine Configuration Data	16-14
PowerTech Medallion	01-1	Viewing Active Engine Service Codes/Diagnostic Trouble Codes (DTCs) . . .	16-16
Engine Serial Number Plate	01-1	Viewing Stored Service Codes/Diagnostic Trouble Codes (DTCs) in the Engine ECU	16-17
Record Engine Serial Number	01-2		
Engine Option Codes	01-3		
Record Fuel Injection Pump Model Number	01-5		
Safety	05-1		
Fuels, Lubricants, and Coolant		Instrument Panel - Elect. Cont. Later Engines	
Diesel Fuel	10-1	Instrument Panels	17-1
Lubricity of Diesel Fuel	10-1	Using Diagnostic Gauge to Access Engine Information	17-4
Handling and Storing Diesel Fuel	10-2	Main Menu Navigation	17-5
Dieselscan Fuel Analysis	10-2	Engine Configuration Data	17-6
Bio-Diesel Fuel	10-3	Accessing Stored Trouble Codes	17-8
Minimizing the Effect of Cold Weather on Diesel Engines	10-4	Accessing Active Trouble Codes	17-10
Diesel Engine Break-In Oil	10-6	Engine Shutdown Codes	17-12
Diesel Engine Oil	10-7	Adjusting Backlighting	17-13
Extended Diesel Engine Oil Service Intervals . .	10-8	Adjusting Contrast	17-15
Mixing of Lubricants	10-8	Selecting Units Of Measurement	17-17
OILSCAN™and COOLSCAN™	10-9	Setup 1-Up Display	17-20
Alternative and Synthetic Lubricants	10-9	Setup 4-Up Display	17-26
Lubricant Storage	10-10		
Grease	10-10	Instrument Panel - Mech. Cont. “270” Engines	
Diesel Engine Coolant	10-11	Instrument Panel (Earlier 4.5 L “270” Engines)	18-1
Drain Intervals for Diesel Engine Coolant	10-12	Instrument Panel (Later 4.5 L “270” Engines) . . .	18-3
Supplemental Coolant Additives	10-13		
Testing Diesel Engine Coolant	10-13	Engine Operation - Except 4.5L “270” Engines	
Operating in Warm Temperature Climates	10-14	Engine Break-In Service	19-1
Disposing of Coolant	10-14	Starting the Engine	19-4
		Normal Engine Operation	19-7
Instrument Panel Identification		Warming Engine	19-8
Instrument Panels - Identification	15-1	Cold Weather Operation	19-9
		Using a Booster Battery or Charger	19-11
Instrument Panel - Elect. Cont. Earlier Engines		Avoid Excessive Engine Idling	19-12
Instrument Panel	16-1	Changing Engine Speed	19-13
Using Diagnostic Gauge to Access Engine Information	16-8	Stopping The Engine	19-16
Using Touch Switches to Display Information	16-10	Auxiliary Gear Drive Limitations	19-17
Changing Units of Measure (English or Metric)	16-12	Generator Set (Standby) Applications	19-17
		Engine Operation- 4.5 L “270” Engines	
		Normal Engine Operation	20-1

Continued on next page

All information, illustrations and specifications in this manual are based on the latest information available at the time of publication. The right is reserved to make changes at any time without notice.

COPYRIGHT © 2004
DEERE & COMPANY
Moline, Illinois
All rights reserved
A John Deere ILLUSTRATION® Manual
Previous Editions
Copyright © 2001, 2002, 2003

Page	Page		
Break-In Service	20-2	Check and Adjust Valve Clearance (All Engines Except 4045HF475 And 6068HF475)	35-9
Auxiliary Gear Drive Limitations	20-3	Check and Adjust Valve Clearance (4045HF475 And 6068HF475 Engines).	35-12
Generator Set (Standby) Power Units.	20-4	Test Glow Plugs for Continuity (4045HF475 And 6068HF475 Engines).	35-15
Starting The Engine	20-4		
Cold Weather Starting	20-6		
Warming Engine.	20-8		
Avoid Excessive Engine Idling	20-9		
Stopping the Engine.	20-10		
Using a Booster Battery or Charger	20-11		
Lubrication and Maintenance		Service as Required	
Observe Service Intervals.	21-1	Additional Service Information	40-1
Use Correct Fuels, Lubricants, and Coolant	21-1	Do Not Modify Fuel System	40-2
Lubrication and Maintenance Service		Adding Coolant.	40-3
Interval Chart—Standard Industrial Engines	21-2	Replacing Single Stage Air Cleaner	40-5
Lubrication and Maintenance Service		Replacing Axial Seal Air Cleaner Filter Element	40-6
Interval Chart—Generator (Standby)		Replacing Radial Seal Air Cleaner Filter Element	40-8
Applications	21-4	Replacing Fan and Alternator Belts	40-10
Lubrication & Maintenance/Daily		Checking Fuses	40-11
Daily Prestarting Checks	25-1	Checking Air Compressors.	40-11
Lubrication & Maintenance/500 Hour/12 Month		Bleeding the Fuel System (Engines With Electronic Fuel Systems And Bosch VP44 Pump).	40-12
Servicing Fire Extinguisher	30-1	Bleed the Fuel System (Engines with Electronic Fuel Systems and Stanadyne DE10 Pump).	40-14
Checking Engine Mounts	30-1	Bleed the Fuel System (Engines with Electronic Fuel Systems and Denso High Pressure Common Rail) (4045HF475, 6068HF475)	40-17
Servicing Battery	30-2	Bleed the Fuel System (4045DF270, 4045TF270)	40-19
Manual Belt Tensioner Adjustment	30-4		
Manual Belt Tensioner Adjustment Using Belt Tension Tool (Alternate Method For Engines Without Auxiliary Drive).	30-5	Troubleshooting	
Changing Engine Oil and Replacing Filter	30-7	General Troubleshooting Information	45-1
Checking Crankcase Vent System	30-9	Precautions For Welding On Engines Equipped With Electronic Engine Control Unit (ECU)	45-2
Checking Air Intake System	30-11	Engine Wiring Layout (Electronic Fuel System With Stanadyne DE10 Injection Pump).	45-3
Replacing Fuel Filter Elements	30-12	Engine Wiring Layout (Electronic Fuel System With Bosch VP44 Injection Pump)	45-4
Checking Belt Tensioner Spring Tension and Belt Wear (Automatic Tensioner)	30-14	Engine Wiring Layout (Electronic Fuel System With Denso High Pressure Common Rail)(4045HF475,6068HF475).	45-5
Checking Engine Electrical Ground Connections	30-16	Engine Wiring Diagram (With Earlier Electronic Instrument Panel)	45-6
Checking Cooling System.	30-16	Engine Wiring Diagram (Engines With Electronic Instrument Panel)	45-7
Replenishing Supplemental Coolant Additives (SCAs) Between Coolant Changes	30-17		
Testing Diesel Engine Coolant	30-19		
Pressure Testing Cooling System.	30-20		
Checking and Adjusting Engine Speeds.	30-21		
Lubrication & Maint./2000 Hour/24 Month			
Adjusting Variable Speed (Droop) — 4.5 L “270” Generator Set Engines Only	35-1		
Checking Crankshaft Vibration Damper (6-Cylinder Engine Only)	35-2		
Flushing and Refilling Cooling System	35-3		
Testing Thermostats Opening Temperature	35-6		

Continued on next page

Page

Page

Engine Wiring Diagram (With Later Full-Featured Electronic Instrument Panel) . . . 45-8

Engine Wiring Diagram (With Later Full-Featured Electronic Instrument Panel)—Continued 45-9

Engine Troubleshooting 45-10

Blink Code Method for Retrieving Diagnostic Trouble Codes (All Except Early VP44 Pump Engines). 45-18

Blink Code Method for Retrieving Diagnostic Trouble Codes (Early VP44 Pump Engines Only). 45-20

Instrument Panel Method for Retrieving Diagnostic Trouble Codes. 45-22

Displaying Of Diagnostic Trouble Codes (DTCs) 45-23

Listing of Diagnostic Trouble Codes (DTCs) (Engines With Electronic Fuel Systems And Stanadyne DE10 Pump) 45-24

Listing of Diagnostic Trouble Codes (DTCs) (Engines With Electronic Fuel Systems And Bosch VP44 Pump). 45-26

Listing of Diagnostic Trouble Codes (DTCs) (Engines With Electronic Fuel Systems And Denso High Pressure Common Rail) (“475” Engines) 45-28

Error Codes Displayed (With Early Electronic Panels). 45-30

Intermittent Fault Diagnostics (With Electronic Controls). 45-31

Displaying Diagnostic Gauge Software (Later Engines). 45-31

Storage

Engine Storage Guidelines 50-1

Preparing Engine for Long Term Storage 50-2

Removing Engine from Long Term Storage 50-3

Specifications

General OEM Engine Specifications. 55-1

Engine Power Ratings And Fuel System Specifications 55-3

Engine Crankcase Oil Fill Quantities 55-6

Unified Inch Bolt and Screw Torque Values 55-7

Metric Bolt and Screw Torque Values. 55-8

Lubrication and Maintenance Records

Using Lubrication and Maintenance Records . . . 60-1

Daily (Prestarting) Service 60-1

500 Hour/12 Month Service 60-2

2000 Hour/24 Month Service 60-3

Service as Required. 60-4

Emission System Warranty

U.S. EPA Emmission Control Warranty Statement 65-1

Emission Control System Certification Label. 65-2

Record Keeping

POWERTECH™ Medallion

A medallion is located on the rocker arm cover which identifies each engine as a John Deere POWERTECH™ engine.

NOTE: Four-valve head engines also have "16V" or "24V" printed on their medallions. The 4045HF475 has "16V" to denote 16 valves total while 6068HF475 has "24V" to denote 24 valves total.



RG11608 -UN-17OCT01



RG11609 -UN-17OCT01

POWERTECH is a trademark of Deere & Company.

OURGP11,0000274 -19-24NOV03-1/1

Engine Serial Number Plate

Each engine has a 13-digit John Deere engine serial number. The first two digits identify the factory that produced the engine:

- "CD" = Saran, France
- "PE" = Torreon, Mexico
- "T0" = Dubuque, Iowa
- "J0" = Rosario, Argentina

The engine's serial number plate (A) is located on the right-hand side of cylinder block behind the fuel filter.

A—Serial Number Plate



RG8007 -UN-15JAN99

13-Digit Engine Serial Number Plate

RG, RG34710, 5506 -19-10NOV01-1/1

Record Engine Serial Number

Record all of the numbers and letters found on your engine serial number plate in the spaces provided below.

This information is very important for repair parts or warranty information.

Engine Serial Number (B)

Engine Model Number (C)

Coefficient of Absorption Value (D)
(Saran Engines Only)



RG11949 -UN-07NOV01

Saran Engine Serial Number Plate



RG11948 -UN-06NOV01

Torreon Engine Serial Number Plate

RG, RG34710, 5507 -19-10NOV01-1/1

Engine Option Codes



A—Engine Base Code

In addition to the serial number plate, OEM engines have an engine option code label affixed to the rocker arm cover. These codes indicate which of the engine options were installed on your engine at the factory. When in need of parts or service, furnish your authorized servicing dealer or engine distributor with these numbers.

The engine option code label includes an engine base code (A). This base code must also be recorded along with the option codes.

The first two digits of each code identify a specific group, such as alternators. The last two digits of each code identify one specific option provided on your engine, such as a 12-volt, 55-amp alternator.

NOTE: These option codes are based on the latest information available at the time of publication. The right is reserved to make changes at any time without notice.

If an engine is ordered without a particular component, the last two digits of that functional group option code will be 99, 00, or XX. The list on the next page shows only the first two digits of the code numbers. For future reference such as ordering repair parts, it is important to have these code numbers available. To ensure this availability, enter the third and fourth digits shown on your engine option code label in the spaces provided on the following page.

NOTE: Your engine option code label may not contain all option codes if an option has been added after the engine left the producing factory.

If option code label is lost or destroyed, consult your servicing dealer or engine distributor selling the engine for a replacement.

An additional option code label may also be delivered with the engine. Place this sticker or tag, for reference, either on this page or in the engine owner's warranty booklet under **OPTION CODES** title.

Option Codes	Description	Option Codes	Description
11_____	Rocker Arm Cover	50_____	Oil Pump
12_____	Oil Fill Inlet	51_____	Cylinder Head With Valves
13_____	Crankshaft Pulley/Damper	52_____	Auxiliary Gear Drive
14_____	Flywheel Housing	53_____	Fuel Heater
15_____	Flywheel	55_____	Shipping Stand
16_____	Fuel Injection Pump	56_____	Paint Option
17_____	Air Inlet	57_____	Coolant Pump Inlet
18_____	Air Cleaner	59_____	Oil Cooler
19_____	Oil Pan	60_____	Add-on Auxiliary Drive Pulley
20_____	Coolant Pump	62_____	Alternator Mounting Bracket
21_____	Thermostat Cover	63_____	Low Pressure Fuel Line
22_____	Thermostat	64_____	Exhaust Elbow
23_____	Fan Drive	65_____	Turbocharger
24_____	Fan Belt	66_____	Coolant Temperature Switch
25_____	Fan	67_____	Electronic Sensors (Base Engine)
26_____	Engine Coolant Heater	68_____	Crankshaft Rear Damper
27_____	Radiator	69_____	Engine Serial Number Plate
28_____	Exhaust Manifold	71_____	Engine Oil Bypass Filter
29_____	Crankcase Ventilator System	72_____	ECU Electronic Software Option
30_____	Starter Motor	74_____	Air Conditioning (Freon) Compressor
31_____	Alternator	75_____	Air Restriction Indicator
32_____	Instrument Panel	76_____	Pressure Switches and Sensors
33_____	Tachometer	77_____	Timing Gear Cover
35_____	Fuel Filters	78_____	Air Compressor
36_____	Front Plate	79_____	Engine Certification
37_____	Fuel Transfer Pump	81_____	Primary Fuel Filter And Water Separator
39_____	Thermostat Housing	83_____	Electronic Software (Vehicle Option)
40_____	Oil Dipstick	84_____	Electrical Wiring Harness
41_____	Belt-Driven Front Auxiliary Drive	86_____	Fan Pulley
43_____	Starting Aid	87_____	Belt Tensioner
44_____	Timing Gear Cover With Gears	88_____	Oil Filter
46_____	Cylinder Block With Liners and Camshaft	95_____	Special Equipment (Factory Installed)
47_____	Crankshaft and Bearings	96_____	Engine Installation Kit
48_____	Connecting Rods and Pistons	97_____	Special Equipment (Field Installed)
49_____	Valve Actuating Mechanism	98_____	Shipping (Engine Hanger Straps)
		99_____	Service Only Items

Engine Base Code (See "A" on previous page.)

Record Fuel Injection Pump Model Number

Record the fuel injection pump model and serial information found on the serial number plate (A).

Model No. _____ RPM _____

Manufacturer's No. _____

Serial No. _____

A—Serial Number Plate



RG11943 -JUN-06NOV01

Record Injection Pump Serial Number

RG, RG34710, 5511 -19-10NOV01-1/1

Safety

Recognize Safety Information

This is a safety-alert symbol. When you see this symbol on your machine or in this manual, be alert to the potential for personal injury.

Follow recommended precautions and safe operating practices.



Safety-alert symbol

T81389 -UN-07DEC88

DX,ALERT -19-29SEP98-1/1

Understand Signal Words

A signal word—DANGER, WARNING, or CAUTION—is used with the safety-alert symbol. DANGER identifies the most serious hazards.

DANGER or WARNING safety signs are located near specific hazards. General precautions are listed on CAUTION safety signs. CAUTION also calls attention to safety messages in this manual.



▲ WARNING

▲ CAUTION

Signal Words

TS187 -19-30SEP88

DX,SIGNAL -19-03MAR93-1/1

Follow Safety Instructions

Carefully read all safety messages in this manual and on your machine safety signs. Keep safety signs in good condition. Replace missing or damaged safety signs. Be sure new equipment components and repair parts include the current safety signs. Replacement safety signs are available from your John Deere dealer.

Learn how to operate the machine and how to use controls properly. Do not let anyone operate without instruction.

Keep your machine in proper working condition. Unauthorized modifications to the machine may impair the function and/or safety and affect machine life.

If you do not understand any part of this manual and need assistance, contact your John Deere dealer.

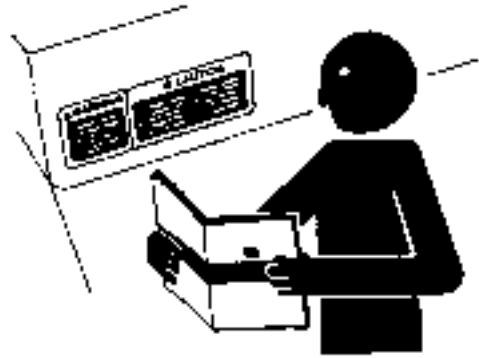

Safety Messages

TSS201 -JUN-23AUG88

DX,READ -19-03MAR93-1/1

Replace Safety Signs

Replace missing or damaged safety signs. See the machine operator's manual for correct safety sign placement.

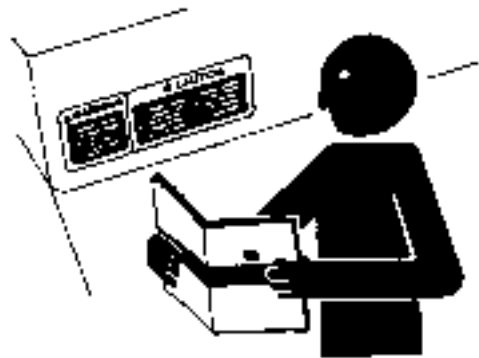

DX,SIGNS1 -19-04JUN90-1/1

TSS201 -JUN-23AUG88

Prevent Bypass Starting

Avoid possible injury or death from engine runaway.

Do not start engine by shorting across starter terminal. Engine will start with PTO engaged if normal circuitry is bypassed.

Start engine only from operator's station with PTO disengaged or in neutral.



Prevent Bypass Starting

RG5419 -UN-28FEB89

RG, RG34710, 7508 -19-30JUN97-1/1

Handle Fuel Safely—Avoid Fires

Handle fuel with care: it is highly flammable. Do not refuel the machine while smoking or when near open flame or sparks.

Always stop engine before refueling machine. Fill fuel tank outdoors.

Prevent fires by keeping machine clean of accumulated trash, grease, and debris. Always clean up spilled fuel.



Avoid Fires

TS202 -UN-23AUG88

DX, FIRE1 -19-03MAR93-1/1

Prepare for Emergencies

Be prepared if a fire starts.

Keep a first aid kit and fire extinguisher handy.

Keep emergency numbers for doctors, ambulance service, hospital, and fire department near your telephone.

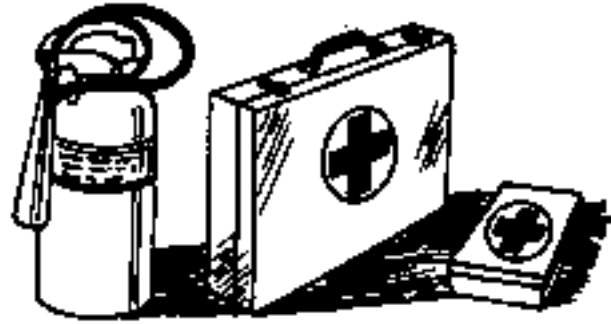

First Aid Kit

TSS291 -UN-23AUG88

DX,FIRE2 -19-03MAR93-1/1

Handle Starting Fluid Safely

Starting fluid is highly flammable.

Keep all sparks and flame away when using it. Keep starting fluid away from batteries and cables.

To prevent accidental discharge when storing the pressurized can, keep the cap on the container, and store in a cool, protected location.

Do not incinerate or puncture a starting fluid container.



Store Safely

TS1356 -UN-18MAR92

DX,FIRE3 -19-16APR92-1/1

Handle Fluids Safely—Avoid Fires

When you work around fuel, do not smoke or work near heaters or other fire hazards.

Store flammable fluids away from fire hazards. Do not incinerate or puncture pressurized containers.

Make sure machine is clean of trash, grease, and debris.

Do not store oily rags; they can ignite and burn spontaneously.



Avoid Fires

TS227 -JUN-23AUG88

DX,FLAME -19-29SEP98-1/1

Service Engines Safely

Tie long hair behind your head. Do not wear a necktie, scarf, loose clothing, or necklace when you work near machine tools or moving parts. If these items were to get caught, severe injury could result.

Remove rings and other jewelry to prevent electrical shorts and entanglement in moving parts.



Moving Parts

TS228 -JUN-23AUG88

OURGP12,00001DA -19-25FEB03-1/1

Wear Protective Clothing

Wear close fitting clothing and safety equipment appropriate to the job.

Prolonged exposure to loud noise can cause impairment or loss of hearing.

Wear a suitable hearing protective device such as earmuffs or earplugs to protect against objectionable or uncomfortable loud noises.

Operating equipment safely requires the full attention of the operator. Do not wear radio or music headphones while operating machine.

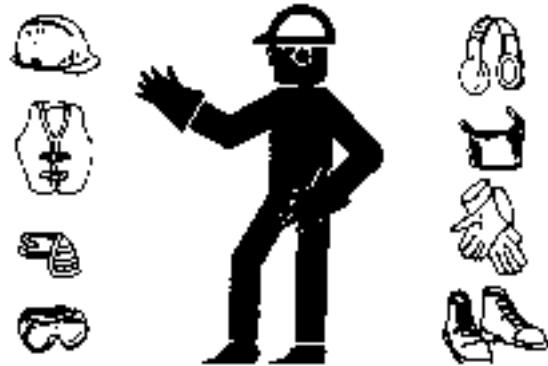

Protective Clothing

TS206 -JUN-23AUG88

DX,WEAR -19-10SEP90-1/1

Protect Against Noise

Prolonged exposure to loud noise can cause impairment or loss of hearing.

Wear a suitable hearing protective device such as earmuffs or earplugs to protect against objectionable or uncomfortable loud noises.



Noise Exposure

TS207 -JUN-23AUG88

DX,NOISE -19-03MAR93-1/1

Handle Chemical Products Safely

Direct exposure to hazardous chemicals can cause serious injury. Potentially hazardous chemicals used with John Deere equipment include such items as lubricants, coolants, paints, and adhesives.

A Material Safety Data Sheet (MSDS) provides specific details on chemical products: physical and health hazards, safety procedures, and emergency response techniques.

Check the MSDS before you start any job using a hazardous chemical. That way you will know exactly what the risks are and how to do the job safely. Then follow procedures and recommended equipment.

(See your John Deere dealer for MSDS's on chemical products used with John Deere equipment.)



Material Safety Data Sheet

TS1132 -UN-26NOV90

DX,MSDS,NA -19-03MAR93-1/1

Stay Clear of Rotating Drivelines

Entanglement in rotating driveline can cause serious injury or death.

Keep tractor master shield and driveline shields in place at all times. Make sure rotating shields turn freely.

Wear close fitting clothing. Stop the engine and be sure PTO driveline is stopped before making adjustments, connections, or cleaning out PTO driven equipment.



Rotating Drivelines

TS1644 -UN-22AUG95

DX,PTO -19-12SEP95-1/1

Practice Safe Maintenance

Understand service procedure before doing work. Keep area clean and dry.

Never lubricate, service, or adjust machine while it is moving. Keep hands, feet, and clothing from power-driven parts. Disengage all power and operate controls to relieve pressure. Lower equipment to the ground. Stop the engine. Remove the key. Allow machine to cool.

Securely support any machine elements that must be raised for service work.

Keep all parts in good condition and properly installed. Fix damage immediately. Replace worn or broken parts. Remove any buildup of grease, oil, or debris.

On self-propelled equipment, disconnect battery ground cable (-) before making adjustments on electrical systems or welding on machine.

On towed implements, disconnect wiring harnesses from tractor before servicing electrical system components or welding on machine.



Keep Area Clean

TS218 -UN-23AUG88

DX,SERV -19-17FEB99-1/1

Work In Ventilated Area

Engine exhaust fumes can cause sickness or death. If it is necessary to run an engine in an enclosed area, remove the exhaust fumes from the area with an exhaust pipe extension.

If you do not have an exhaust pipe extension, open the doors and get outside air into the area



Engine exhaust fumes

TS220 -UN-23AUG88

DX,AIR -19-17FEB99-1/1

Avoid High-Pressure Fluids

Escaping fluid under pressure can penetrate the skin causing serious injury.

Avoid the hazard by relieving pressure before disconnecting hydraulic or other lines. Tighten all connections before applying pressure.

Search for leaks with a piece of cardboard. Protect hands and body from high pressure fluids.

If an accident occurs, see a doctor immediately. Any fluid injected into the skin must be surgically removed within a few hours or gangrene may result. Doctors unfamiliar with this type of injury should reference a knowledgeable medical source. Such information is available from Deere & Company Medical Department in Moline, Illinois, U.S.A.



High-Pressure Fluids

X9811 -UN-23AUG88

DX,FLUID -19-03MAR93-1/1

Avoid Heating Near Pressurized Fluid Lines

Flammable spray can be generated by heating near pressurized fluid lines, resulting in severe burns to yourself and bystanders. Do not heat by welding, soldering, or using a torch near pressurized fluid lines or other flammable materials. Pressurized lines can be accidentally cut when heat goes beyond the immediate flame area.



Flammable Spray

TS953 -UN-15MAY90

DX,TORCH -19-03MAR93-1/1

Do Not Open High-Pressure Fuel System

High-pressure fluid remaining in fuel lines can cause serious injury. Do not disconnect or attempt repair of fuel lines, sensors, or any other components between the high-pressure fuel pump and nozzles on engines with High Pressure Common Rail (HPCR) fuel system.

Only technicians familiar with this type of system can perform repairs. (See your John Deere dealer.)



High-Pressure Fuel Lines

TS1343 -UN-18MAR92

DX,WW,HPCR1 -19-07JAN03-1/1

Remove Paint Before Welding or Heating

Avoid potentially toxic fumes and dust.

Hazardous fumes can be generated when paint is heated by welding, soldering, or using a torch.

Remove paint before heating:

- Remove paint a minimum of 100 mm (4 in.) from area to be affected by heating. If paint cannot be removed, wear an approved respirator before heating or welding.
- If you sand or grind paint, avoid breathing the dust. Wear an approved respirator.
- If you use solvent or paint stripper, remove stripper with soap and water before welding. Remove solvent or paint stripper containers and other flammable material from area. Allow fumes to disperse at least 15 minutes before welding or heating.

Do not use a chlorinated solvent in areas where welding will take place.

Do all work in an area that is well ventilated to carry toxic fumes and dust away.

Dispose of paint and solvent properly.



Toxic Fumes

TS220 -UN-23AUG88

DX,PAINT -19-24JUL02-1/1

Service Cooling System Safely

Explosive release of fluids from pressurized cooling system can cause serious burns.

Shut off engine. Only remove filler cap when cool enough to touch with bare hands. Slowly loosen cap to first stop to relieve pressure before removing completely.



Cooling System

TSS281 -JUN-23AUG88

DX,RCAP -19-04JUN90-1/1

Install Fan Guards

Rotating cooling system fans can cause serious injury.

Keep fan guards in place at all times during engine operation. Wear close fitting clothes. Stop the engine and be sure fan is stopped before making adjustments or connections, or cleaning near the front of the engine.



Rotating Fan

TSS677 -JUN-21SEP89

OUOD006,000009D -19-04DEC02-1/1

Avoid Hot Parts

Avoid skin contact with exhaust manifolds, turbochargers and mufflers. Keep flammable materials clear of the turbocharger.

External dry exhaust parts become very hot during operation. Turbochargers may reach temperatures as high as 500°C (932°F) under full load, and naturally aspired exhaust manifolds may reach 600°C (1112°F) under full load. This may ignite paper, cloth or wooden materials. Parts on engines that have been at full load and reduced to no load idle will maintain approximately 150°C (302°F).



Hot Surface

TS271 -JUN-23AUG88

OUOD006,000009E -19-04DEC02-1/1

Avoid Harmful Asbestos Dust

Avoid breathing dust that may be generated when handling components containing asbestos fibers. Inhaled asbestos fibers may cause lung cancer.

Components in products that may contain asbestos fibers are brake pads, brake band and lining assemblies, clutch plates, and some gaskets. The asbestos used in these components is usually found in a resin or sealed in some way. Normal handling is not hazardous as long as airborne dust containing asbestos is not generated.

Avoid creating dust. Never use compressed air for cleaning. Avoid brushing or grinding material containing asbestos. When servicing, wear an approved respirator. A special vacuum cleaner is recommended to clean asbestos. If not available, apply a mist of oil or water on the material containing asbestos.

Keep bystanders away from the area.



Asbestos Dust

TS220 -JUN-23AUG88

DX,DUST -19-15MAR91-1/1

Prevent Battery Explosions

Keep sparks, lighted matches, and open flame away from the top of battery. Battery gas can explode.

Never check battery charge by placing a metal object across the posts. Use a volt-meter or hydrometer.

Do not charge a frozen battery; it may explode. Warm battery to 16°C (60°F).



Battery Explosions

TSS204 -JUN-23AUG88

DX,SPARKS -19-03MAR93-1/1

Handling Batteries Safely

CAUTION: Battery gas can explode. Keep sparks and flames away from batteries. Use a flashlight to check battery electrolyte level.

Never check battery charge by placing a metal object across the posts. Use a voltmeter or hydrometer.

Always remove grounded (—) battery clamp first and replace it last.

CAUTION: Sulfuric acid in battery electrolyte is poisonous. It is strong enough to burn skin, eat holes in clothing, and cause blindness if splashed into eyes.

Avoid the hazard by:

1. Filling batteries in a well-ventilated area.
2. Wearing eye protection and rubber gloves.
3. Avoiding breathing fumes when electrolyte is added.
4. Avoiding spilling or dripping electrolyte.
5. Using proper jump start procedure.

If you spill acid on yourself:

1. Flush your skin with water.
2. Apply baking soda or lime to help neutralize the acid.
3. Flush your eyes with water for 15—30 minutes. Get medical attention immediately.

If acid is swallowed:

1. Do not induce vomiting.
2. Drink large amounts of water or milk, but do not exceed 2 L (2 qt.).
3. Get medical attention immediately.

WARNING: Battery posts, terminals, and related accessories contain lead and lead compounds, chemicals known to the State of California to cause cancer and reproductive harm. **Wash hands after handling.**



Explosion

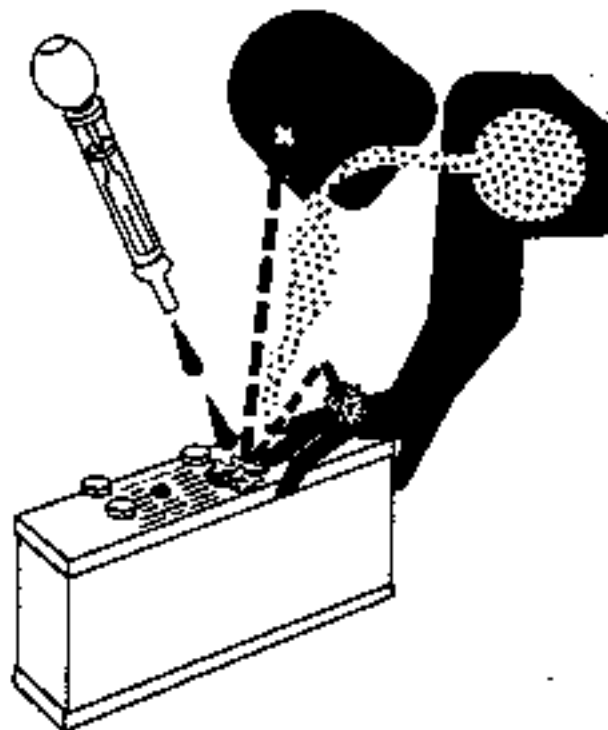

Acid

TS204 -JUN-23AUG88

TS203 -JUN-23AUG88

Protect Against High Pressure Spray

Spray from high pressure nozzles can penetrate the skin and cause serious injury. Keep spray from contacting hands or body.

If an accident occurs, see a doctor immediately. Any high pressure spray injected into the skin must be surgically removed within a few hours or gangrene may result. Doctors unfamiliar with this type of injury should reference a knowledgeable medical source. Such information is available from Deere & Company Medical Department in Moline, Illinois, U.S.A.



High Pressure Spray

TS1343 -UN-18MAR92

DX,SPRAY -19-16APR92-1/1

Dispose of Waste Properly

Improperly disposing of waste can threaten the environment and ecology. Potentially harmful waste used with John Deere equipment include such items as oil, fuel, coolant, brake fluid, filters, and batteries.

Use leakproof containers when draining fluids. Do not use food or beverage containers that may mislead someone into drinking from them.

Do not pour waste onto the ground, down a drain, or into any water source.

Air conditioning refrigerants escaping into the air can damage the Earth's atmosphere. Government regulations may require a certified air conditioning service center to recover and recycle used air conditioning refrigerants.

Inquire on the proper way to recycle or dispose of waste from your local environmental or recycling center, or from your John Deere dealer.



Recycle Waste

TS1133 -UN-26NOV90

DX,DRAIN -19-03MAR93-1/1

Fuels, Lubricants, and Coolant

Diesel Fuel

Consult your local fuel distributor for properties of the diesel fuel available in your area.

In general, diesel fuels are blended to satisfy the low temperature requirements of the geographical area in which they are marketed.

Diesel fuels specified to EN 590 or ASTM D975 are recommended.

In all cases, the fuel shall meet the following properties:

Cetane number of 45 minimum. Cetane number greater than 50 is preferred, especially for temperatures below -20°C (-4°F) or elevations above 1500 m (5000 ft).

Cold Filter Plugging Point (CFPP) below the expected low temperature OR **Cloud Point** at least 5°C (9°F) below the expected low temperature.

Fuel lubricity should pass a minimum of 3100 gram load level as measured by the BOCLE scuffing test.

Sulfur content:

- Sulfur content should not exceed 0.5%. Sulfur content less than 0.05% is preferred.
- If diesel fuel with sulfur content greater than 0.5% sulfur content is used, reduce the service interval for engine oil and filter by 50%.
- DO NOT use diesel fuel with sulfur content greater than 1.0%.

Bio-diesel fuels may be used ONLY if the fuel properties meet DIN 51606 or equivalent specification.

DO NOT mix used engine oil or any other type of lubricant with diesel fuel.

OURGP11,000018C -19-12FEB04-1/1

Lubricity of Diesel Fuel

Diesel fuel must have adequate lubricity to ensure proper operation and durability of fuel injection system components.

ASTM D975 and EN 590 specifications do not require fuels to pass a fuel lubricity test.

Sulfur content of diesel fuel for highway use is less than 0.05% (500 ppm) in the United States and Canada, and less than 0.035% (350 ppm) in the European Union.

Experience shows that some low sulfur diesel fuels may have inadequate lubricity and their use may reduce performance in fuel injection systems due to inadequate lubrication of injection pump components. The lower concentration of aromatic compounds in

these fuels also adversely affects injection pump seals and may result in leaks.

Use of low lubricity diesel fuels may also cause accelerated wear, injection nozzle erosion or corrosion, engine speed instability, hard starting, low power, and engine smoke.

Fuel lubricity should pass a minimum load level of 3100 grams as measured by ASTM D6078 or maximum scar diameter of 0.45 mm as measured by ASTM D6079 or ISO 12156-1.

If fuel of low or unknown lubricity is used, add John Deere PREMIUM DIESEL FUEL CONDITIONER (or equivalent) at the specified concentration.

DX,FUEL5 -19-19DEC03-1/1

Handling and Storing Diesel Fuel



CAUTION: Handle fuel carefully. Do not fill the fuel tank when engine is running.

DO NOT smoke while you fill the fuel tank or service the fuel system.

Fill the fuel tank at the end of each day's operation to prevent water condensation and freezing during cold weather.

Keep all storage tanks as full as practicable to minimize condensation.

Ensure that all fuel tank caps and covers are installed properly to prevent moisture from entering. Monitor water content of the fuel regularly.

When using bio-diesel fuel, the fuel filter may require more frequent replacement due to premature plugging.

Check engine oil level daily prior to starting engine. A rising oil level may indicate fuel dilution of the engine oil.

IMPORTANT: The fuel tank is vented through the filler cap. If a new filler cap is required, always replace it with an original vented cap.

When fuel is stored for an extended period or if there is a slow turnover of fuel, add a fuel conditioner to stabilize the fuel and prevent water condensation. Contact your fuel supplier for recommendations.

DX,FUEL4 -19-19DEC03-1/1

Dieselscan Fuel Analysis

DIESELSCAN™ is a John Deere fuel sampling program to help you monitor the quality of your fuel source. It verifies fuel type, cleanliness, water content, suitability for cold weather operation, and if fuel is within ASTM specifications. Check with your John Deere dealer for availability of DIESELSCAN kits.

DIESELSCAN is a trademark of Deere & Company

DX,FUEL6 -19-06DEC00-1/1

Bio-Diesel Fuel

Consult your local fuel distributor for properties of the bio-diesel fuel available in your area.

Bio-diesel fuels may be used ONLY if the bio-diesel fuel properties meet the latest edition of ASTM D6751, EN 14214, or equivalent specification.

It has been found that bio-diesel fuels may improve lubricity in concentrations up to a 5% blend (also known as B5) in petroleum diesel fuel.

When using a blend of bio-diesel fuel, the engine oil level must be checked daily when the air temperature is -10°C (14°F) or lower. If oil becomes diluted with fuel, shorten oil change intervals accordingly.

IMPORTANT: Raw pressed vegetable oils are NOT acceptable for use as fuel in any concentration in John Deere engines.

These oils do not burn completely, and will cause engine failure by leaving deposits on injectors and in the combustion chamber.

A major environmental benefit of bio-diesel fuel is its ability to biodegrade. This makes proper storage and

handling of bio-diesel fuel especially important. Areas of concern include:

- Quality of new fuel
- Water content of the fuel
- Problems due to aging of the fuel

Potential problems resulting from deficiencies in the above areas when using bio-diesel fuel in concentrations above 5% may lead to the following symptoms:

- Power loss and deterioration of performance
- Fuel leakage
- Corrosion of fuel injection equipment
- Coked and/or blocked injector nozzles, resulting in engine misfire
- Filter plugging
- Lacquering and/or seizure of internal components
- Sludge and sediments
- Reduced service life of engine components

Consult your fuel supplier for additives to improve storage and performance of bio-diesel fuels.

DX,FUEL7 -19-05JAN04-1/1

Minimizing the Effect of Cold Weather on Diesel Engines

John Deere diesel engines are designed to operate effectively in cold weather.

However, for effective starting and cold weather operation, a little extra care is necessary. The information below outlines steps that can minimize the effect that cold weather may have on starting and operation of your engine. See your authorized engine distributor or servicing dealer for additional information and local availability of cold weather aids.

Use Grade No. 1-D Fuel

When temperatures fall below 5°C (40°F), Grade No. 1-D fuel is best suited for cold weather operation. Grade No. 1-D fuel has a lower cloud point and a lower pour point.

Cloud point is the temperature at which wax will begin to form in the fuel and this wax causes fuel filters to plug. **Pour point** is the temperature at which fuel begins to thicken and becomes more resistant to flow through fuel pumps and lines.

NOTE: On an average, Grade No. 1-D fuel has a lower BTU (heat content) rating than Grade No. 2-D fuel. When using Grade No. 1-D fuel you may notice a drop in power and fuel efficiency, but should not experience any other engine performance effects. Check the grade of fuel being used before troubleshooting for low power complaints in cold weather operation.

Air Intake Heaters

This option is available on suffix "275" engines and later "270" engines. Air intake heaters are located on the cylinder head.

IMPORTANT: Do NOT use ether when starting with air intake heaters.

Fuel Heaters

Two options are available with fuel heaters: one location is at the inlet port of the primary fuel filter, while the other location is at the inlet port of the final fuel filter.

Coolant Heaters

Engine block heaters (coolant) are an available option to aid cold weather starting.

Glow Plugs

Glow plugs are used to aid cold weather starting on engines equipped with the 4 valve cylinder head (475 suffix).

IMPORTANT: Do NOT use ether when starting with glow plugs.

Seasonal Viscosity Oil and Proper Coolant Concentration

Use seasonal grade viscosity engine oil based on expected air temperature range between oil changes and a proper concentration of low silicate antifreeze as recommended. (See DIESEL ENGINE OIL and ENGINE COOLANT REQUIREMENTS later in this section).

Diesel Fuel Flow Additive

IMPORTANT: Treat fuel when outside temperature drops below 0°C (32°F). For best results, use with untreated fuel. Follow all recommended instructions on label.

Use John Deere Premium Diesel Fuel Conditioner (Winter) or equivalent to treat fuel during the cold weather season. This winter formulation is a combination diesel fuel conditioner and anti-gel additive.

Winterfronts

Use of fabric, cardboard, or solid winterfronts is not recommended with any John Deere engine. Their use can result in excessive engine coolant, oil, and charge air temperatures. This can lead to reduced engine life, loss of power and poor fuel economy. Winterfronts may also put abnormal stress on fan and fan drive components potentially causing premature failures.

If winterfronts are used, they should never totally close off the grill frontal area. Approximately 25% area in the center of the grill should remain open at all times. At no time should the air blockage device be applied directly to the radiator core.

Radiator Shutters

If equipped with a thermostatically controlled radiator shutter system, this system should be regulated in such a way that the shutters are completely open by the time the coolant reaches 93°C (200°F) to prevent excessive intake manifold temperatures. Manually controlled systems are not recommended.

If air-to-air aftercooling is used, the shutters must be completely open by the time the intake manifold air temperature reaches the maximum allowable temperature out of the charge air cooler.

For more information, see your John Deere engine distributor or servicing dealer.

RG, RG34710, 7529 -19-25FEB03-2/2

Diesel Engine Break-In Oil

New engines are filled at the factory with John Deere ENGINE BREAK-IN OIL. During the break-in period, add John Deere ENGINE BREAK-IN OIL as needed to maintain the specified oil level.

Change the oil and filter after the first 100 hours of operation of a new or rebuilt engine.

After engine overhaul, fill the engine with John Deere ENGINE BREAK-IN OIL.

If John Deere ENGINE BREAK-IN OIL is not available, use a diesel engine oil meeting one of the following during the first 100 hours of operation:

- API Service Category CE
- API Service Category CD
- API Service Category CC
- ACEA Oil Sequence E2
- ACEA Oil Sequence E1

After the break-in period, use John Deere PLUS-50™ or other diesel engine oil as recommended in this manual.

IMPORTANT: Do not use PLUS-50 oil or engine oils meeting any of the following during the first 100 hours of operation of a new or rebuilt engine:

API CI-4	ACEA E5
API CH-4	ACEA E4
API CG-4	ACEA E3
API CF-4	
API CF-2	
API CF	

These oils will not allow the engine to break-in properly.

Diesel Engine Oil

Use oil viscosity based on the expected air temperature range during the period between oil changes.

John Deere PLUS-50™ oil is preferred.

Oils meeting one of the following specifications are also recommended

- ACEA Oil Sequence E5
- ACEA Oil Sequence E4

Extended service intervals may apply when John Deere PLUS-50, ACEA E5, or ACEA E4 engine oils are used. Consult your John Deere dealer for more information.

Other oils may be used if they meet one or more of the following:

- John Deere TORQ-GARD SUPREME™
- API Service Category CI-4
- API Service Category CH-4
- ACEA Oil Sequence E3

Multi-viscosity diesel engine oils are preferred. Diesel fuel quality and fuel sulfur content must comply with all existing emissions regulations for the area in which the engine operates.

If diesel fuel with sulfur content greater than 0.05% (500 ppm) is used, reduce the service interval by 100 hours.

If diesel fuel with sulfur content greater than 0.5% (5000 ppm) is used, reduce the service interval by 50%.

DO NOT use diesel fuel with sulfur content greater than 1.0% (10 000 ppm).

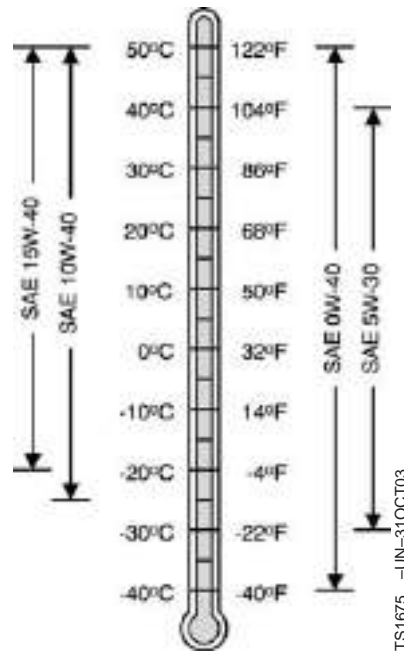

PLUS-50 is a trademark of Deere & Company
 TORQ-GARD SUPREME is a trademark of Deere & Company

DX,ENOIL7 -19-07NOV03-1/1

Extended Diesel Engine Oil Service Intervals

When John Deere PLUS-50™, ACEA E5, or ACEA E4 oils are used with the specified John Deere filter, the service interval for engine oil and filter changes may be increased by 50% but not to exceed a maximum of 500 hours.

If John Deere PLUS-50, ACEA E5, or ACEA E4 oils are used with other than the specified John Deere filter, change the engine oil and filter at the normal service interval.

If John Deere TORQ-GARD SUPREME™, API CI-4, API CH-4, or ACEA E3 oils are used, change the engine oil and filter at the normal service interval.

DX,ENOIL8 -19-03NOV03-1/1

Mixing of Lubricants

In general, avoid mixing different brands or types of oil. Oil manufacturers blend additives in their oils to meet certain specifications and performance requirements.

Consult your John Deere dealer to obtain specific information and recommendations.

Mixing different oils can interfere with the proper functioning of these additives and degrade lubricant performance.

DX,LUBMIX -19-18MAR96-1/1

OILSCAN™ and COOLSCAN™

OILSCAN™ and COOLSCAN™ are John Deere sampling programs to help you monitor machine performance and identify potential problems before they cause serious damage.

Oil and coolant samples should be taken from each system prior to its recommended change interval.

Check with your John Deere dealer for the availability of OILSCAN™ and COOLSCAN™ kits.

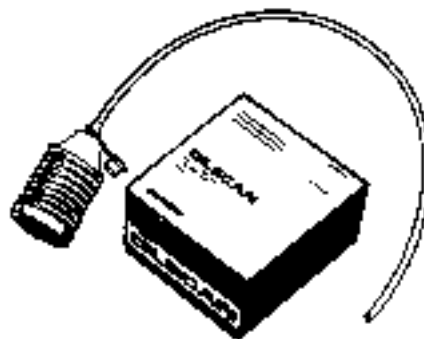

T6828AB -JUN-15JUN89

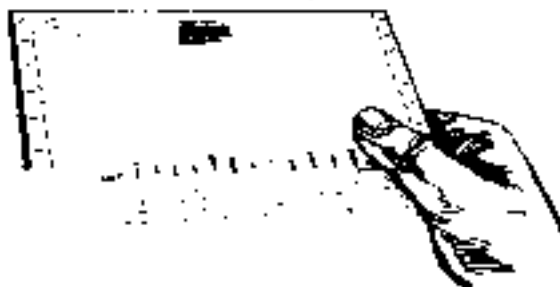

T6829AB -JUN-18OCT88

*OILSCAN is a registered trademark of Deere & Company.
COOLSCAN is a trademark of Deere & Company.*

DX,OILSCAN -19-02DEC02-1/1

Alternative and Synthetic Lubricants

Conditions in certain geographical areas may require lubricant recommendations different from those printed in this manual.

Some John Deere brand coolants and lubricants may not be available in your location.

Consult your John Deere dealer to obtain information and recommendations.

Synthetic lubricants may be used if they meet the performance requirements as shown in this manual.

The temperature limits and service intervals shown in this manual apply to both conventional and synthetic oils.

Re-refined base stock products may be used if the finished lubricant meets the performance requirements.

DX,ALTER -19-15JUN00-1/1

Lubricant Storage

Your equipment can operate at top efficiency only when clean lubricants are used.

Use clean containers to handle all lubricants.

Whenever possible, store lubricants and containers in an area protected from dust, moisture, and other contamination. Store containers on their side to avoid water and dirt accumulation.

Make certain that all containers are properly marked to identify their contents.

Properly dispose of all old containers and any residual lubricant they may contain.

DX,LUBST -19-18MAR96-1/1

Grease

Use grease based on NLGI consistency numbers and the expected air temperature range during the service interval.

The following greases are preferred:

- John Deere SD POLYUREA GREASE

The following greases are also recommended:

- John Deere HD MOLY GREASE
- John Deere HD LITHIUM COMPLEX GREASE
- John Deere HD WATER RESISTANT GREASE
- John Deere GREASE-GARD

Other greases may be used if they meet the following:

- NLGI Performance Classification GC-LB

IMPORTANT: Some types of grease thickener are not compatible with others. Consult your grease supplier before mixing different types of grease.

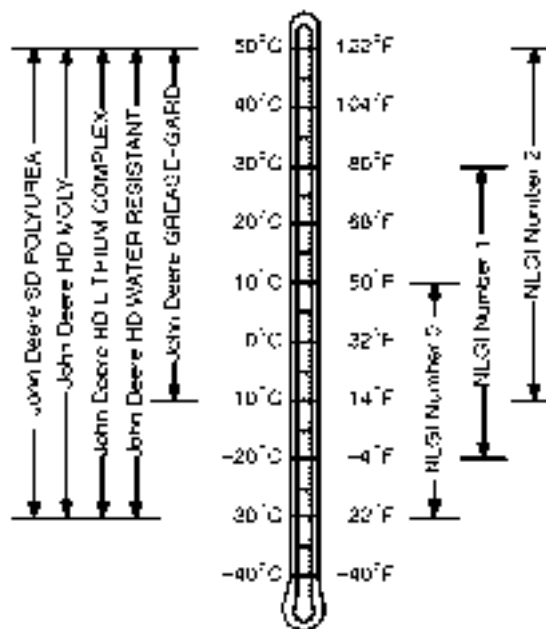

TS1667 -UN-30JUN99

DX,GREA1 -19-14NOV03-1/1

Diesel Engine Coolant

The engine cooling system is filled to provide year-round protection against corrosion and cylinder liner pitting, and winter freeze protection to -37°C (-34°F). If protection at lower temperatures is required, consult your John Deere dealer for recommendations.

John Deere COOL-GARD™ Prediluted Coolant is preferred for service.

John Deere COOL-GARD Prediluted Coolant is available in either a concentration of 50% ethylene glycol or a 55% propylene glycol.

Additional recommended coolants

The following engine coolant is also recommended:

- John Deere COOL-GARD Coolant Concentrate in a 40% to 60% mixture of concentrate with quality water.

John Deere COOL-GARD coolants do not require use of supplemental coolant additives, except for periodic replenishment of additives during the drain interval.

Other fully formulated coolants

Other fully formulated low silicate ethylene or propylene glycol base coolants for heavy-duty engines may be used if they meet one of the following specifications:

- ASTM D6210 prediluted (50%) coolant
- ASTM D6210 coolant concentrate in a 40% to 60% mixture of concentrate with quality water

Coolants meeting ASTM D6210 do not require use of supplemental coolant additives, except for periodic replenishment of additives during the drain interval.

Coolants requiring supplemental coolant additives

Other low silicate ethylene glycol base coolants for heavy-duty engines may also be used if they meet one of the following specifications:

- ASTM D4985 ethylene glycol base prediluted (50%) coolant
- ASTM D4985 ethylene glycol base coolant concentrate in a 40% to 60% mixture of concentrate with quality water

Coolants meeting ASTM D4985 require an initial charge of supplemental coolant additives, formulated for protection of heavy duty diesel engines against corrosion and cylinder liner erosion and pitting. They also require periodic replenishment of additives during the drain interval.

Other coolants

If a coolant known to meet the requirements of coolant specifications shown in this manual is not available, use either:

- ethylene glycol or propylene glycol base prediluted (40% to 60%) coolant
- ethylene glycol or propylene glycol base coolant concentrate in a 40% to 60% mixture of concentrate with quality water

The coolant concentrate or prediluted coolant shall be of a quality that provides cavitation protection to cast iron and aluminum parts in the cooling system.

Water quality

Water quality is important to the performance of the cooling system. Distilled, deionized, or demineralized water is recommended for mixing with ethylene glycol and propylene glycol base engine coolant concentrate.

IMPORTANT: Do not use cooling system sealing additives or antifreeze that contains sealing additives.

IMPORTANT: Do not mix ethylene glycol and propylene glycol base coolants.

DX,COOL3 -19-19DEC03-2/2

Drain Intervals for Diesel Engine Coolant

Drain the factory fill engine coolant, flush the cooling system, and refill with new coolant after the first 3 years or 3000 hours of operation.

Subsequent drain intervals are determined by the coolant used for service. At each interval, drain the coolant, flush the cooling system, and refill with new coolant.

When John Deere COOL-GARD™ is used, the drain interval may be extended to 5 years or 5000 hours of operation, provided that the coolant is tested annually AND additives are replenished, as needed, by adding a supplemental coolant additive.

If John Deere COOL-GARD is used but the coolant is not tested OR additives are not replenished by adding a supplemental coolant additive, the drain interval is 3 years or 3000 hours of operation

If COOL-GARD is not used, the drain interval is reduced to 2 years or 2000 hours of operation.

COOL-GARD is a trademark of Deere & Company

DX,COOL11 -19-19DEC03-1/1

Supplemental Coolant Additives

The concentration of coolant additives is gradually depleted during engine operation. For all recommended coolants, replenish additives between drain intervals by adding a supplemental coolant additive every 12 months or as determined necessary by coolant testing.

John Deere COOLANT CONDITIONER is recommended as a supplemental coolant additive in John Deere engines.

IMPORTANT: Do not add a supplemental coolant additive when the cooling system is drained and refilled with John Deere COOL-GARD™.

If other coolants are used, consult the coolant supplier and follow the manufacturer's recommendation for use of supplemental coolant additives.

The use of non-recommended supplemental coolant additives may result in additive drop-out and gelation of the coolant.

Add the manufacturer's recommended concentration of supplemental coolant additive. DO NOT add more than the recommended amount.

COOL-GARD is a trademark of Deere & Company

DX,COOL4 -19-07NOV03-1/1

Testing Diesel Engine Coolant

Testing Diesel Engine Coolant

Maintaining adequate concentrations of glycol and inhibiting additives in the coolant is critical to protect the engine and cooling system against freezing, corrosion, and cylinder liner erosion and pitting.

Test the coolant solution at intervals of 12 months or less and whenever excessive coolant is lost through leaks or overheating.

Coolant test strips

Coolant test strips are available from your John Deere dealer. These test strips provide a simple, effective

method to check the freeze point and additive levels of your engine coolant.

Compare the results to the supplemental coolant additive (SCA) chart to determine the amount of inhibiting additives in your coolant and whether more John Deere COOLANT CONDITIONER should be added.

COOLSCAN™ and COOLSCAN PLUS™

For a more thorough evaluation of your coolant, perform a COOLSCAN or COOLSCAN PLUS analysis, where available. See your John Deere dealer for information.

COOLSCAN is a trademark of Deere & Company

COOLSCAN PLUS is a trademark of Deere & Company

DX,COOL9 -19-19DEC03-1/1

Operating in Warm Temperature Climates

John Deere engines are designed to operate using glycol base engine coolants.

Always use a recommended glycol base engine coolant, even when operating in geographical areas where freeze protection is not required.

IMPORTANT: Water may be used as coolant *in emergency situations only.*

Foaming, hot surface aluminum and iron corrosion, scaling, and cavitation will occur when water is used as the coolant, even when coolant conditioners are added.

Drain cooling system and refill with recommended glycol base engine coolant as soon as possible.

DX,COOL6 -19-18MAR96-1/1

Disposing of Coolant

Improperly disposing of engine coolant can threaten the environment and ecology.

Use leakproof containers when draining fluids. Do not use food or beverage containers that may mislead someone into drinking from them.

Do not pour waste onto the ground, down a drain, or into any water source.

Inquire on the proper way to recycle or dispose of waste from your local environmental or recycling center, or from your John Deere engine distributor or servicing dealer.



TS1133 -UN-26NOV90

RG,RG34710,7543 -19-30JUN97-1/1

Instrument Panel Identification

Instrument Panels - Identification

The instrument panels shown compare the panel offered for mechanically controlled "270" series engines (shown at right) and electronically controlled earlier engines and electronically controlled later engines (shown on next page). The electronically controlled earlier instrument panel operation is covered in Section 16. The electronically controlled later instrument panels (Full-Featured and Basic versions) are covered in Section 17. The mechanically controlled "270" series engines are covered in Section 18.

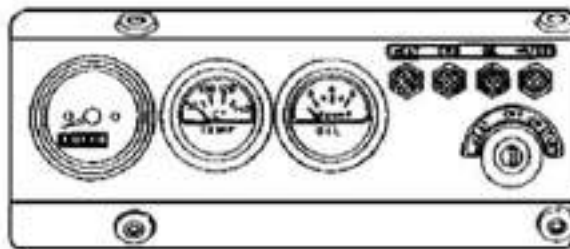

RG13343 -UN-24NOV03

*Instrument Panel For Earlier Mechanically Controlled "270" Engines
(See Section 18)*

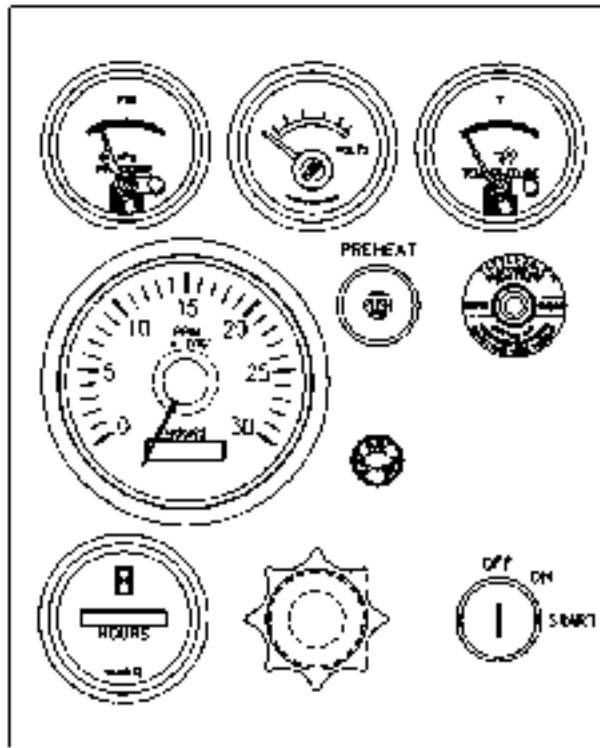

RG13359 -UN-06FEB04

*Instrument Panel For Later Mechanically Controlled "270" Engines
(See Section 18)*

Continued on next page

OURGP11,0000133 -19-20NOV03-1/2

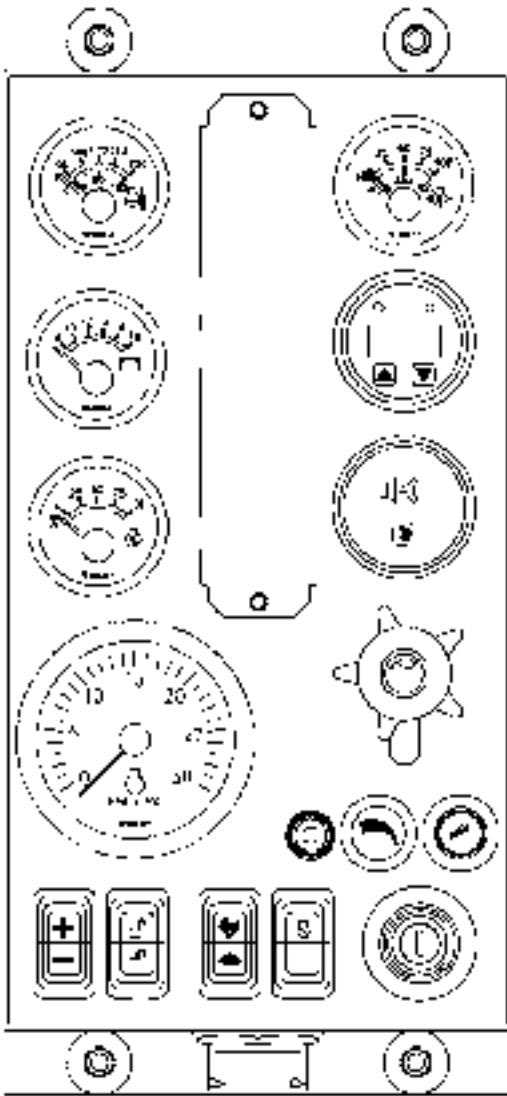

Instrument Panel For Earlier Electronically Controlled Engines (See Section 16)

RG13273 -UN-20NOV03

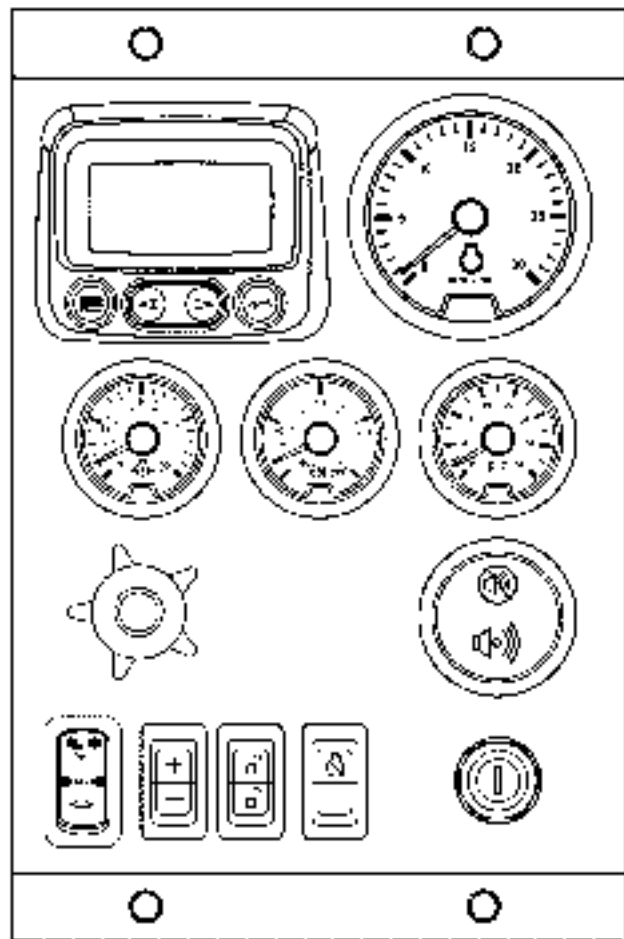

Full-Featured Instrument Panel For Later Electronically Controlled Engines (See Section 17)

RG13274 -UN-28OCT03

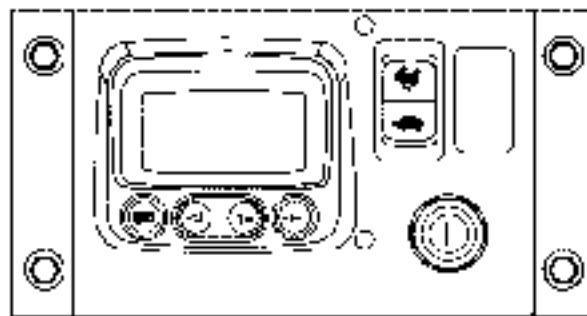

Basic Instrument Panel For Later Electronically Controlled Engines (See Section 17)

RG13275 -UN-21OCT03

OURGP11,0000133 -19-20NOV03-2/2

Instrument Panel - Elect. Cont. Earlier Engines

Instrument Panel

This instrument panel for earlier *POWERTECH*™ 4.5 L and 6.8 L electronically controlled engines is electronically linked to the John Deere engine control unit (ECU). This allows the operator to monitor engine performance as well as to diagnose any troubles during engine operation.

All electronic engine controls are optional equipment for John Deere *POWERTECH*™ OEM Engines. These electronic controls may be provided by the equipment manufacturer instead of purchased from John Deere. Refer to your engine application manual for specific guidelines if John Deere sourced controls and instrumentation are not used.

- A—Engine Oil Pressure Gauge
- B—Amber “WARNING” Indicator
- C—Red “STOP ENGINE” Indicator
- D—Diagnostic Gauge/Hour Meter
- E—Touch Switch
- F—Touch Switch
- G—Audible Alarm (Optional)
- H—Audible Alarm Override Switch (Optional)
- I—Analog Throttle Control (Optional)
- J—Dimmer Control (Optional)
- K—Engine Preheater Indicator (Optional)
- L—Key Start Switch
- M—Override Shutdown Rocker Switch
- N—High-Low Speed Select Rocker Switch
- O—Bump Speed Enable Rocker Switch
- P—Speed Select Rocker Switch
- Q—Fuse Holder (5-Amp Fuse)
- R—Tachometer
- S—Power Meter (Percent Load) (Optional)
- T—Voltmeter (Optional)
- U—Engine Coolant Temperature Gauge

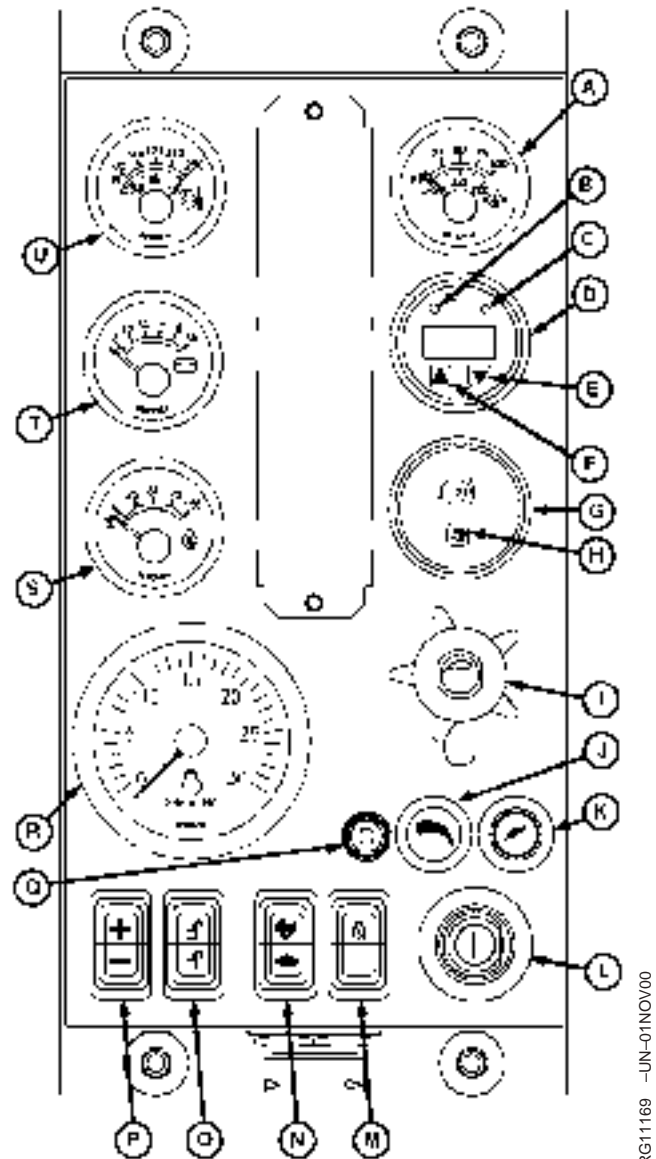

Instrument Panel (Earlier Electronically Controlled Engines)

IMPORTANT: Any time an electric gauge or meter does not register correctly, replace with a new one. Do not attempt to repair it. All gauges are plug-in type.

Following is a brief description of the electronic controls found on John Deere-provided instrument panels. Refer to manufacturer's literature for information on controls not provided by Deere.

Engine Oil Pressure Gauge

The engine oil pressure gauge (A) indicates engine oil pressure in pounds per square inch (psi) or kPa. An optional audible alarm (G) warns the operator if engine oil pressure falls below a safe operating pressure.

Amber "Warning" Indicator

The amber "WARNING" indicator (B) signals an abnormal condition such as low oil pressure, high coolant temperature, water in fuel, low battery voltage, etc. Observe displayed code in window of diagnostic gauge/hour meter (D) for diagnostic trouble code (DTC). (Use the service code menu. See USING DIAGNOSTIC GAUGE TO ACCESS ENGINE INFORMATION later in this section.)

Red "Stop Engine" Indicator

The Red "STOP ENGINE" indicator (C) signals operator to stop engine immediately or as soon as safely possible. A condition exists that could cause damage to engine.

Diagnostic Gauge/Hour Meter

The diagnostic gauge/hour meter (D) displays diagnostic trouble codes (DTCs) as they are accessed. Other information on the engine can be accessed using the touch switches (E and F). The hour meter shows the operating hours of the engine. If engine trouble occurs, the gauge will alternately flash from displayed parameter to the message "SvrcCode". Then the touch switches (E and F) can be used to access the trouble code (see following).

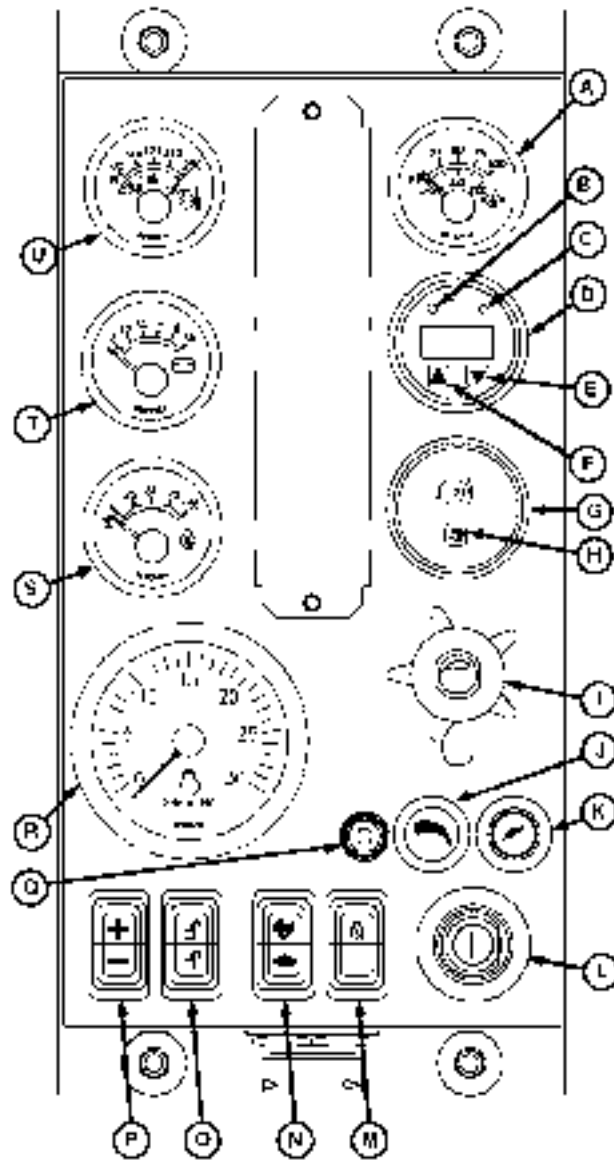

Instrument Panel

RG11169 -JUN-01NOV00

Touch Switches

The touch switches are used to change the display on the window of the diagnostic gauge to access engine performance data. Pressing the DOWN switch (E) or UP switch (F) scrolls through various engine parameters and diagnostic trouble codes. (See Using Diagnostic Gauge To Access Engine Information on the following pages for instructions.)

Audible Alarm (Optional)

The audible alarm (G) sounds whenever a low oil pressure, high coolant temperature or water-in-fuel/plugged fuel filter condition exists. This includes all signals that light up the amber "WARNING" indicator (B) or the red "STOP ENGINE" indicator (C).

Audible Alarm Override Switch (Optional)

The audible alarm override switch (H) can be pressed to silence the alarm for approximately 2-1/2 minutes.

Analog Throttle Control (Optional)

The throttle control (I) is used to control engine speed. This control is available only on engines with analog throttle.

Dimmer Control (Optional)

The dimmer control (J) is used to control illumination of the instrument panel gauges.

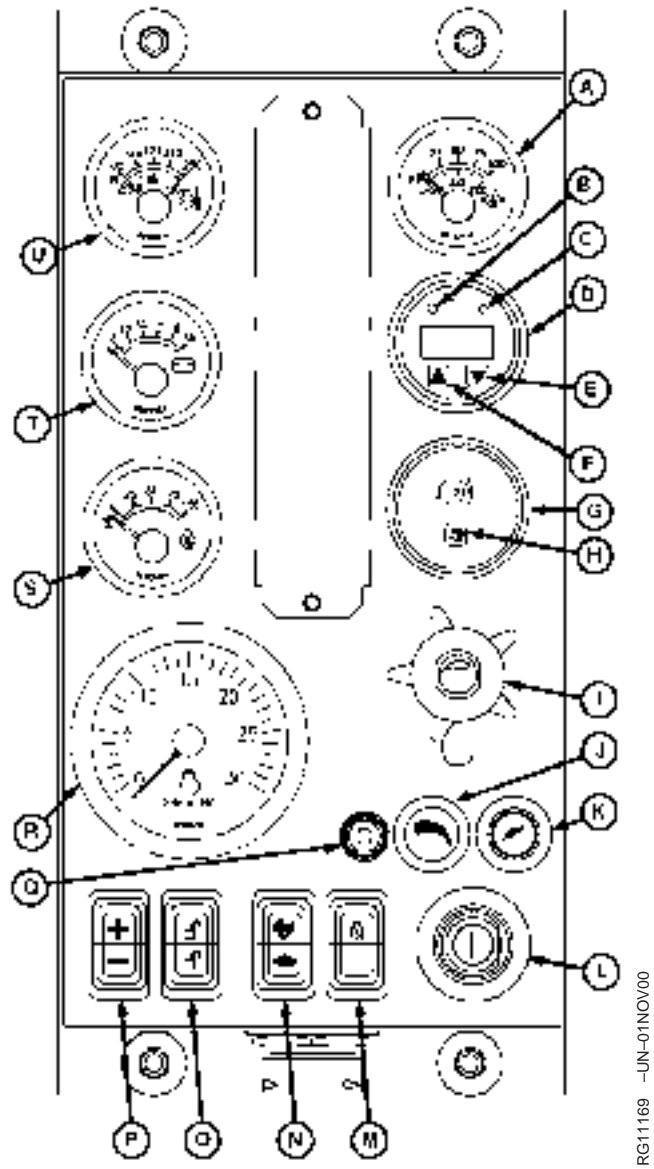

Instrument Panel For Earlier Engines

Continued on next page

OURGP11,000027A -19-25NOV03-3/7

Engine Preheater Indicator (Optional)

The engine preheater indicator (K) lights up while the engine is being preheated for cold weather starting. When the engine is warmed up, the light goes off, indicating the engine can now be started.

Key Start Switch

The three-position key start switch (L) controls the engine electrical system. When the key switch is turned clockwise to "START", the engine will crank. When the engine starts, the key is released and returns to the "ON" (RUN) position.

Override Shutdown Rocker Switch

Switch will be present, but may not be active, depending on engine controller (ECU) options originally selected. If switch is active, pressing the upper half of the override shutdown switch (M) will override an engine shutdown signal. The switch must be pressed within 30 seconds to prevent undesired shutdown of engine. Pressing this switch will override the engine shutdown for 30 seconds at a time to move vehicle to a safe location.

High-Low Speed Select Rocker Switch

This instrument panel has two versions, one with a two position switch as shown, and one with a three position switch. The two position switch has high/low and is used to set the engine operating speeds at slow (turtle) or fast (rabbit). Factory preset idle speeds can also be adjusted using bump speed enable switch (O) with speed select switch (P).

The three position switch has Slow (turtle), Middle (Adj) and Fast (rabbit) settings. Slow (turtle) position is factory preset at low engine idle, while middle (ADJ) position is factory set at high engine idle. To adjust engine speeds, See Changing Engine Speeds in Section 18.

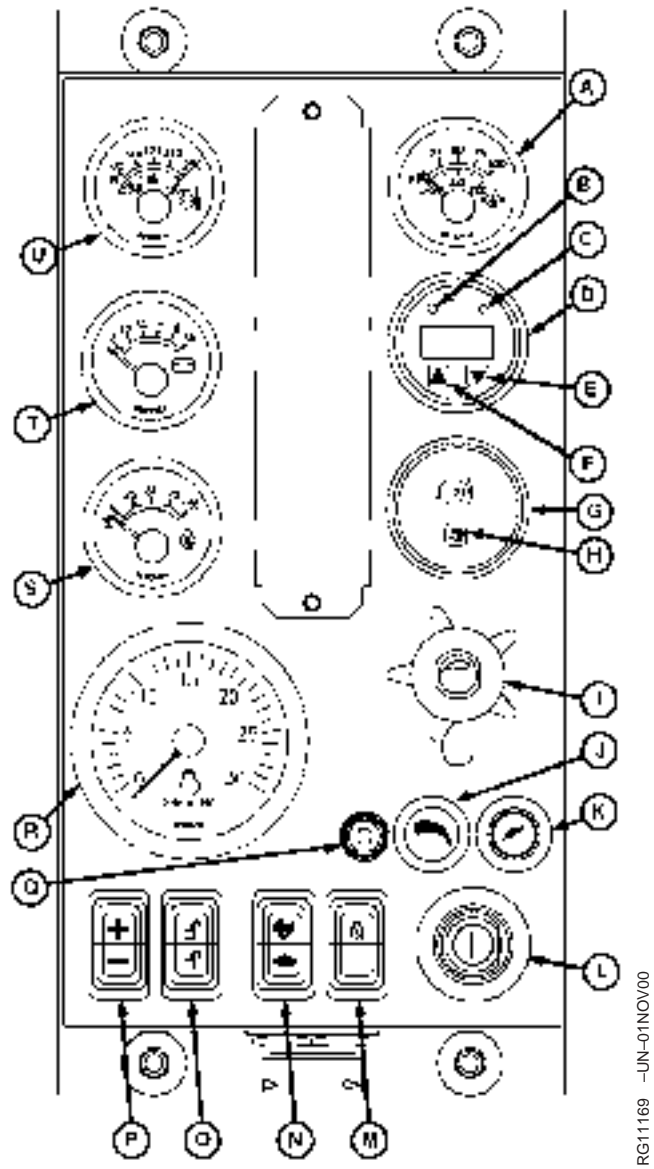

Instrument Panel For Earlier Engines

Continued on next page

OURGP11,000027A -19-25NOV03-4/7

Bump Speed Enable Rocker Switch

This is a three-position switch (O) with the center position as "OFF" (locked). With this switch in the "OFF" position, the speed select switch (P) is also locked, to prevent accidental changes in operating speed. Pressing upper or lower half of switch (O) will unlock or enable the bump speed switch to take effect using speed select switch (P).

Speed Select Rocker Switch

The speed select switch (P) is used to bump engine speed up (+) or down (-) in small increments during operation. This switch must be used with the bump speed enable switch (O) in the unlocked position (top or bottom half of button depressed).

How To Select Preset Operating Speeds (Bump Speeds)

First select slow or fast speed option by pressing high-low speed select switch (N) to "turtle" (slow) or "rabbit" (fast). Then you can press either the upper or lower portion of the bump speed enable switch (O) to unlock the high or low setting. The bump speed enable must be held down as the speed select switch (P) is used to change the high or low setting by pressing (+) to increase speed or (-) to decrease speed.

Once the slow idle speed has been set, the bump speed enable **switch must be pressed and released three times within two seconds to commit the new operating speed to memory.** If not done, the engine's new speed will only be effective until the key switch is shut off. Then the speed will revert back to the previous setting.

The fast idle speed cannot be locked into memory. It will always go back to the factory preset fast idle speed.

Fuse Holder

The fuse holder (Q) contains a 5-amp fuse for power to the instrument panel.

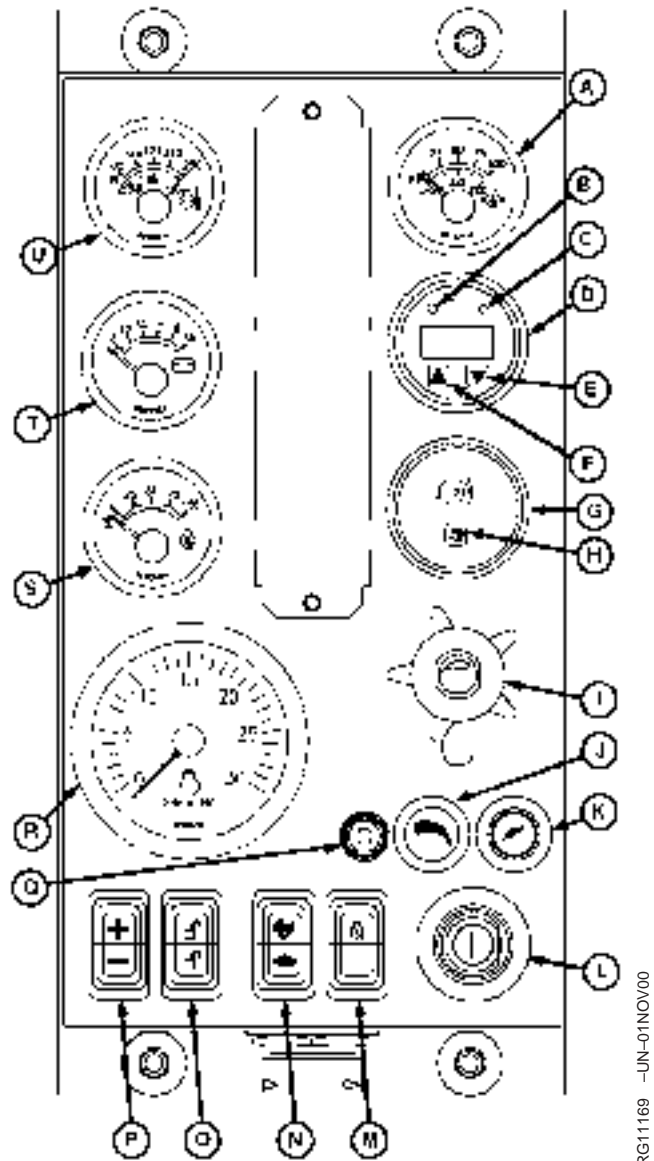

Instrument Panel For Earlier Engines

RG11169 -JUN-01NOV/00

Tachometer

The tachometer (R) indicates engine speed in hundreds of revolutions per minute (rpm).

Percent Load (Optional)

The power meter (S) shows percent of available power being used by the engine.

Voltmeter

The voltmeter (T) indicates system battery voltage. The amber "WARNING" light (B) will illuminate when battery voltage is too low for proper operation of the fuel injection system.

Engine Coolant Temperature Gauge

The coolant temperature gauge (U) indicates engine coolant temperature in degrees Celsius or Fahrenheit. An optional audible alarm (G) warns the operator if coolant temperature rises above the preset safe operating temperature.

Cruise Control

Engine ECUs are available with the cruise control function. The cruise control is an off-road type that maintains a constant engine rpm under varying load conditions.

The cruise cancel/resume function is a one-button cancel, then resume, function. The first time contact is made with the cruise control active, the cruise control will disengage and the engine speed will drop to idle. If the contact is made again within one minute and with the engine speed above 1300 rpm, the cruise control will "resume". This feature allows the placement of the cancel/resume button in a convenient location in the vehicle cab and does not require the use of the normal cruise controls for momentary interruptions in cruise operation.

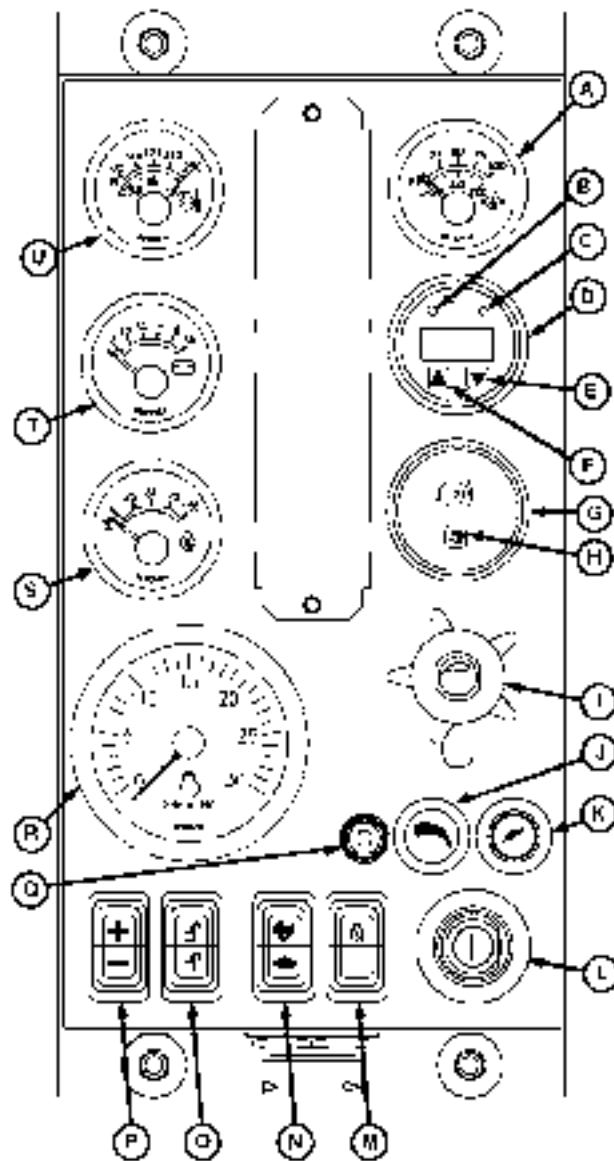

Instrument Panel For Earlier Engines

RG11169 -JUN-01NOV00

The cancel/resume function is intended for applications like agricultural tractors and sprayers that turn around at the end of each row in a field. This allows the operator to use the throttle and/or brake to turn the vehicle around. When ready to resume field operations, the operator brings the engine speed above 1300 rpm and activates the cancel/resume function again to resume cruise speed. An internal timer gives the operator one minute to complete the turnaround maneuver.

The cruise control has the normal functions of:

- Cruise control power "ON" or "OFF".
- "Set" or "bump up" engine speed.
- "Resume" or "bump down" engine speed.
- Use vehicle brake or clutch pedal to disengage cruise control.

The "bump up" and "bump down" speed controls allow the operator to change the set speed. Small engine speed changes can be made by "bumping" the control switch. Holding the "bump up" or "bump down" switch will result in greater engine rpm changes until the engine reaches either full speed or idle. The cruise control cannot operate beyond the normal min/max engine speeds.

OURGP11,000027A -19-25NOV03-7/7

Using Diagnostic Gauge to Access Engine Information

The diagnostic gauge (A) allows the operator to view many readouts of engine functions and diagnostic trouble codes (DTCs). The gauge is linked to the electronic control system and its sensors. This allows the operator to monitor engine functions and to troubleshoot the engine systems when needed.

Press the two touch switches (B) to view the various engine functions in sequence. The displays can be selected as either customary English or metric units.

NOTE: Engine parameters which can be accessed will vary with the engine application.

The following menu of engine parameters can be displayed on the diagnostic gauge window:

- Accelerator pedal position
- Percentage load @ current speed
- Actual engine percent torque
- Engine speed
- Trip distance
- Total vehicle distance
- Engine hours
- Trip fuel
- Total fuel used
- Coolant temperature
- Fuel temperature
- Engine oil temperature
- Engine intercooler temperature
- Fuel delivery pressure
- Engine oil level
- Engine oil pressure
- Coolant pressure
- Coolant level
- Wheel base vehicle speed
- Fuel rate
- Barometric pressure
- Air inlet temperature
- Boost pressure
- Intake manifold temperature
- Air filter differential pressure
- Exhaust gas temperature

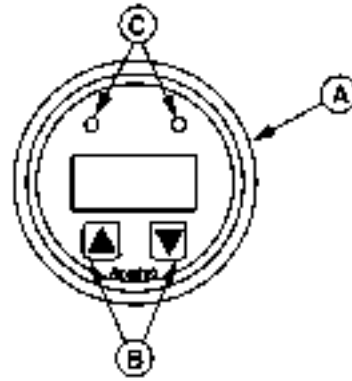

Diagnostic Gauge (Earlier Engines)

A—Diagnostic Gauge
B—Touch Switches
C—Lights

RG10031 -JUN-28OCT99

- Electrical potential (voltage)
- Battery potential (voltage), switched
- Transmission oil pressure
- Transmission oil temperature
- Injector metering rail #1 pressure
- Injector metering rail #2 pressure
- Estimated percent fan speed
- Active service (diagnostic) codes
- Stored service (diagnostic) codes

NOTE: Engine parameters which can be accessed will vary with the engine application.

The diagnostic gauge includes a two-line by eight-character backlit Liquid Crystal Display (LCD). The top line displays the data label, i.e. "EngHrs" and the bottom line displays the matching unit information, i.e. "1246 hrs.". The diagnostic gauge uses two touch switches (UP and DOWN) for scrolling through the engine parameter list and viewing the menu list. Two lights (C) (amber and red) are used to signal active trouble messages received by the diagnostic gauge.

OURGP11,000027B -19-25NOV03-2/2

Using Touch Switches to Display Information

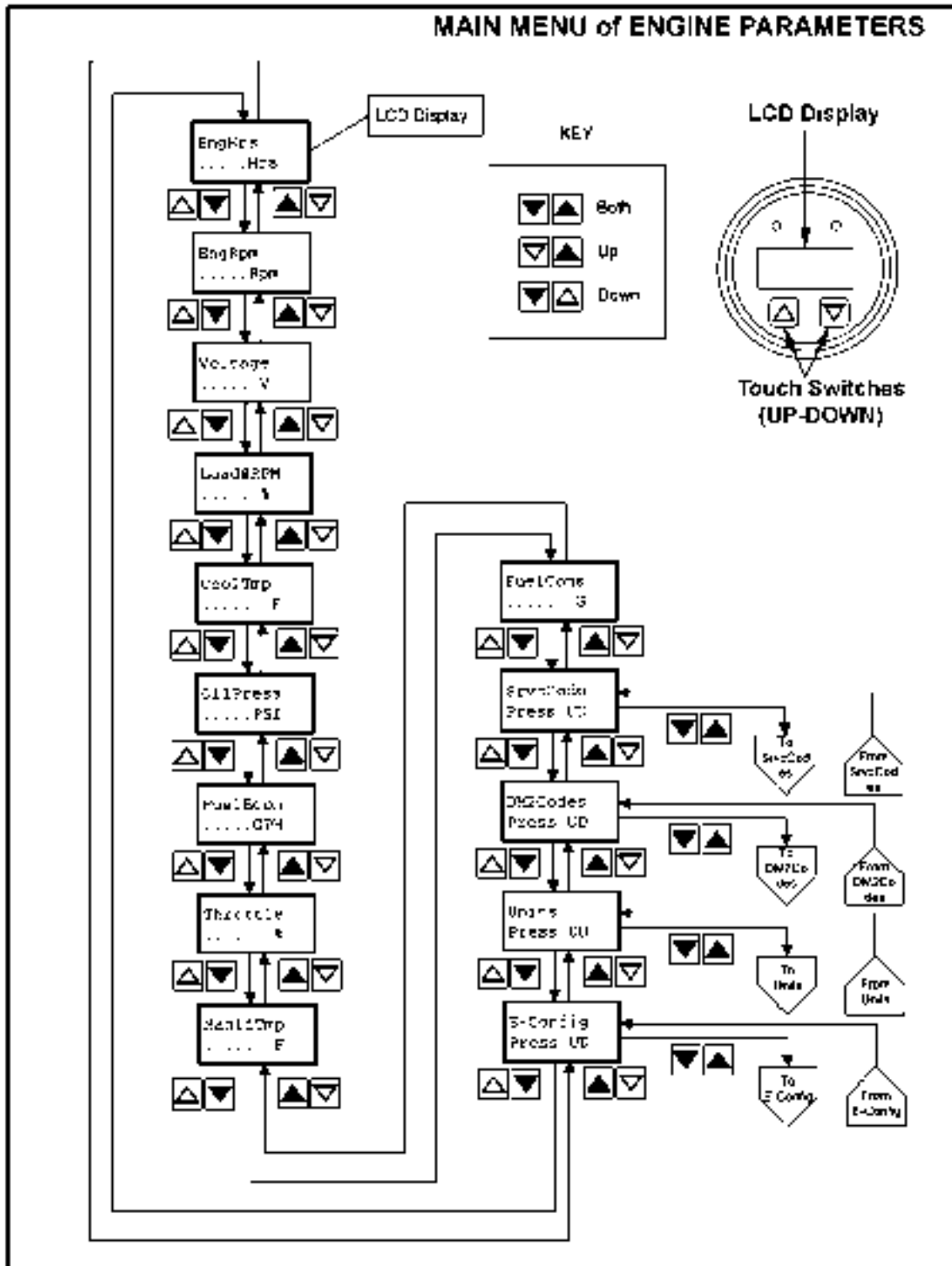

RG9947 -19-08DEC99

Using Touch Switches

Continued on next page

DPSG.OUOD007.2841 -19-01DEC00-1/2

The touch switches on the diagnostic gauge allow quick and easy navigation through the menu to find the information needed.

The diagram on the preceding page is a typical Main Menu of Engine Parameters. The Main Menu has 14 entries; the first 10 are engine data parameters, and the last four are sub-menu entry points.

Accessing the Menus

The following two rules are used for accessing the various items on the menus:

1. To scroll through the parameter list, press **either** the UP or DOWN touch switch.
2. To select or exit a sub-menu, **simultaneously** press the UP and DOWN switches.

Selecting Engine Data Parameters

To read any of the engine parameters, press either UP or DOWN switch (as shown on diagram) until the top line of the display shows the desired information.

Selecting Sub-Menus

Press either the UP or DOWN switch until the top line of the display shows the label of the desired sub-menu. Then press **BOTH** the UP and DOWN switches at the same time. This action will select the sub-menu and the next screen on the display will list the sub-menu items. This is also the way to access diagnostic trouble codes (DTCs).

DPSG,OUOD007,2841 -19-01DEC00-2/2

Changing Units of Measure (English or Metric)

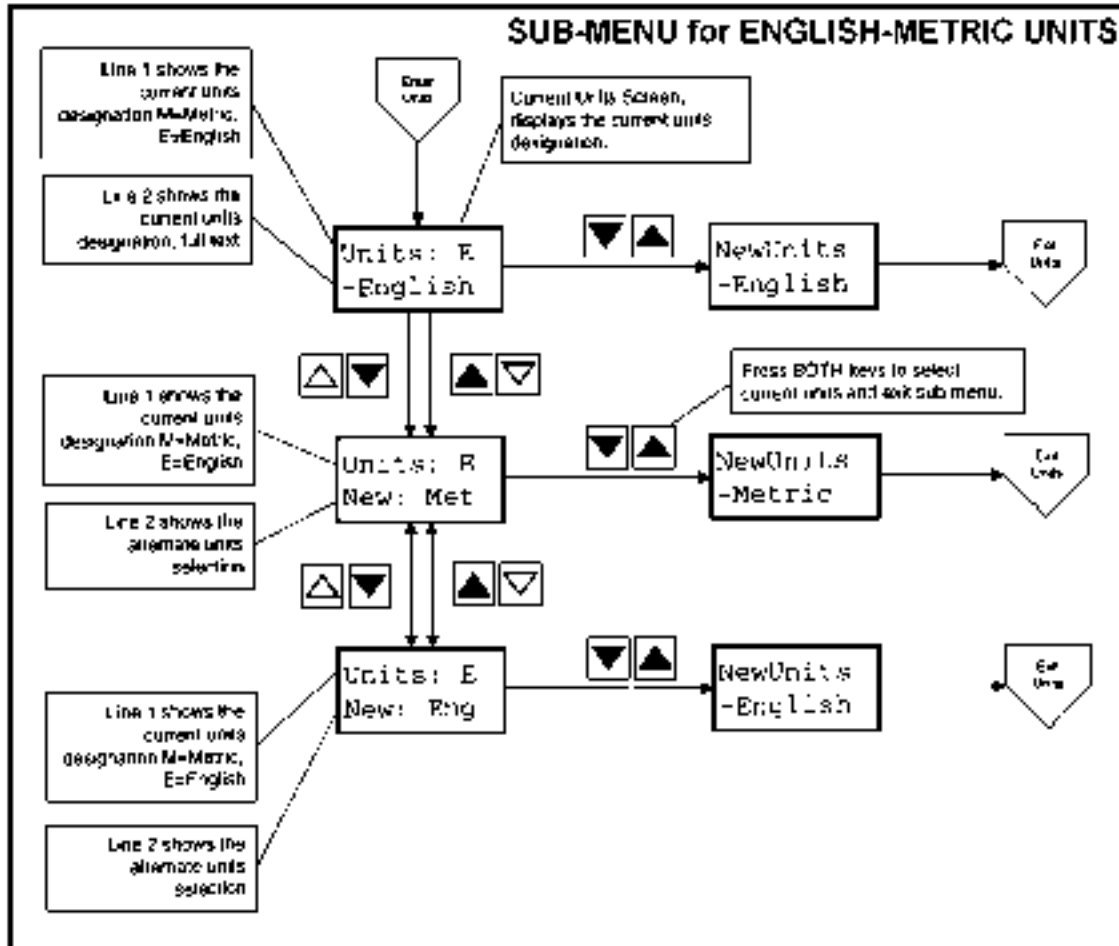

RG10018 -19-28OCT99

Changing Units Of Measure

The diagnostic gauge can display engine data in either English or Metric units. To toggle between these, the *Units Sub-Menu*, must be selected.

To select the *Units Sub-Menu*, press the UP or DOWN switch until the top line of the display reads "Units". Then press BOTH the UP and DOWN switches at the same time to select the *Units Sub-Menu*. The above

diagram shows the steps for selecting the desired units of measure. Two options are available:

1. Press both the switches to retain the current units designation.
2. Press either UP or DOWN switch to toggle the units selection, then press both switches to select the desired unit of measure.

DPSG,OUOD007,2842 -19-21OCT99-1/1

Viewing Engine Configuration Data

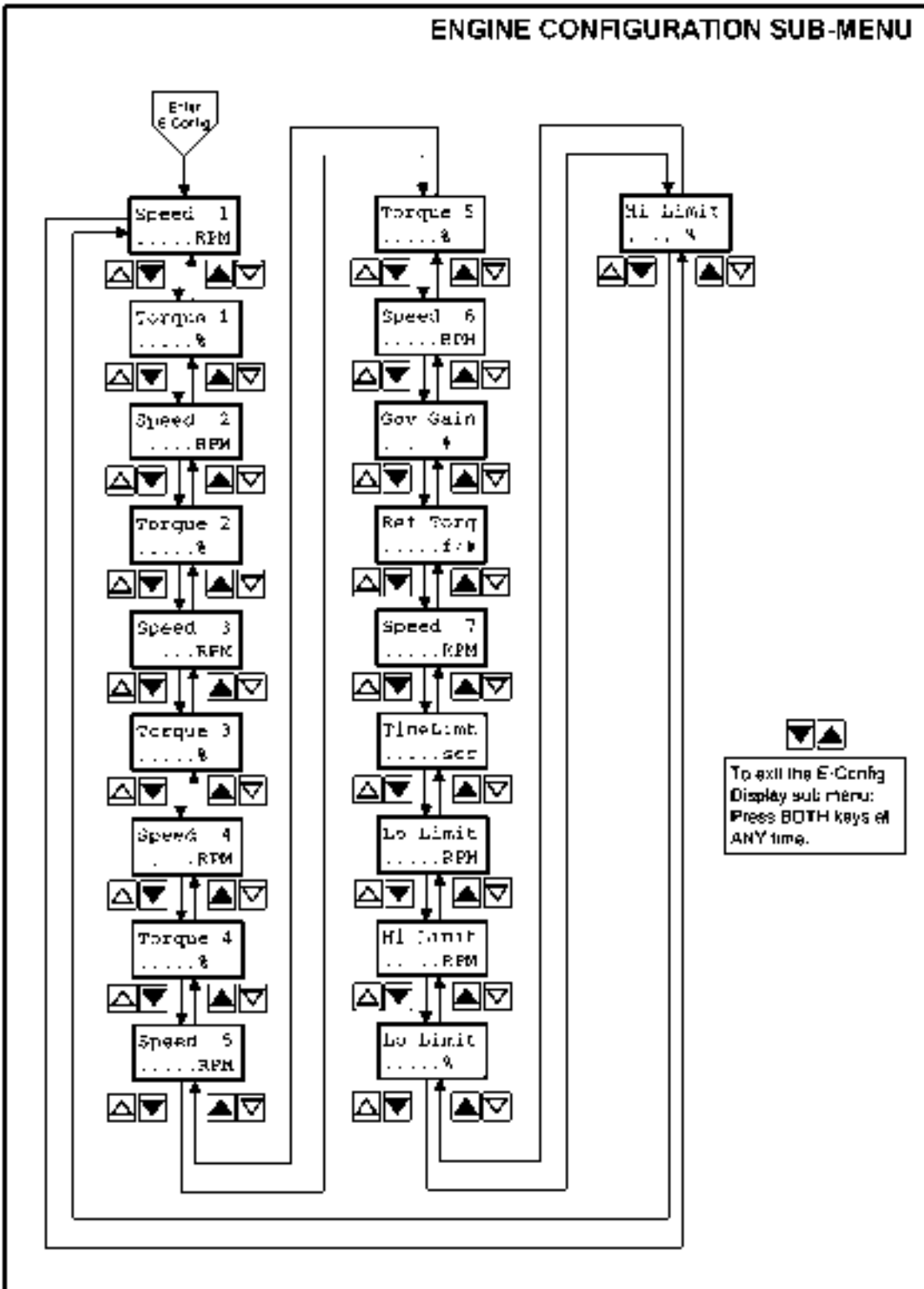

To exit the E-Config Display sub menu: Press BOTH keys at ANY time.

RG10019 -19-28OCT99

Viewing Engine Configuration Data

Continued on next page

DPSG.OUOD007.2842 -19-21OCT99-1/2

The diagnostic gauge can display the engine configuration data stored in the engine control unit (ECU). To select the *Engine Configuration Sub-Menu* (see diagram on previous page), press the UP or DOWN switch until the top line of the display reads

“E-Config”. Then press BOTH the UP and DOWN switches at the same time to select the *Engine Configuration Sub-Menu*. The diagnostic gauge will display the engine configuration data as shown in the diagram.

DPSG,OUOD007,2842 -19-21OCT99-2/2

Viewing Active Engine Service Codes/Diagnostic Trouble Codes (DTCs)

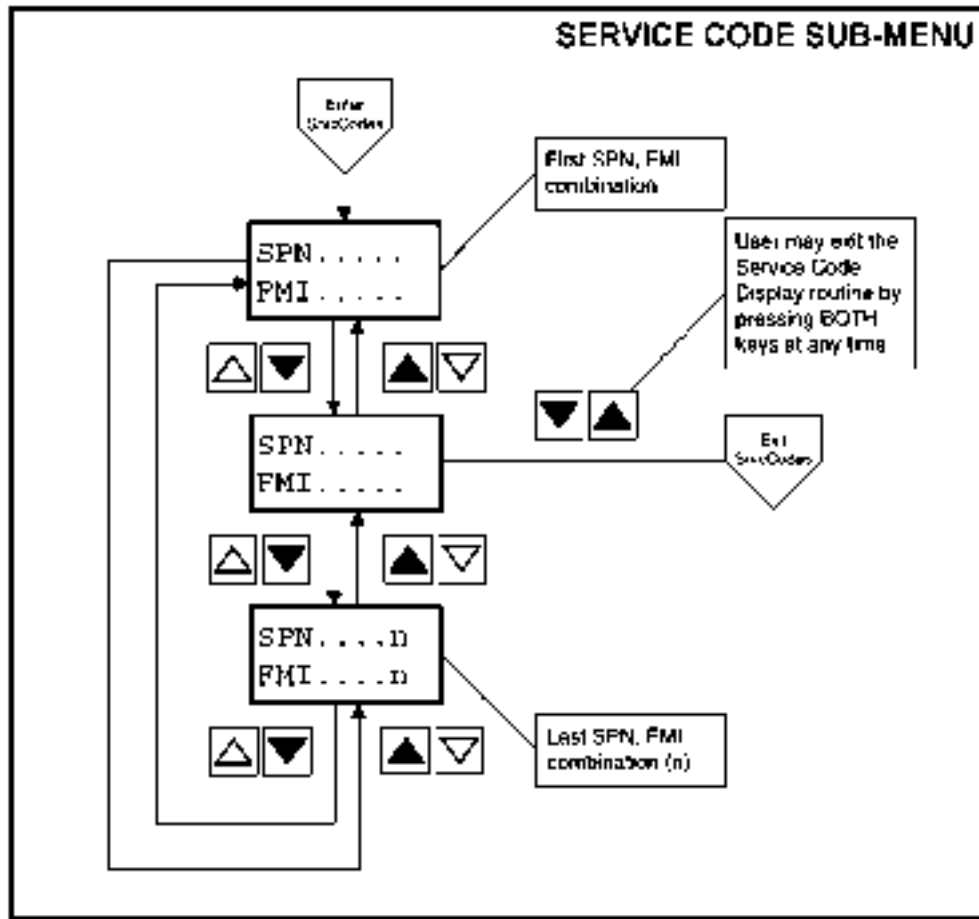

RG11170 -JUN-02NOV00

Viewing Active Service Codes/Diagnostic Trouble Codes (DTCs)

The diagnostic gauge continuously monitors all messages broadcast over the Control Area Network (CAN) and displays all active service codes /diagnostic trouble codes (DTCs) at the time the message is broadcast. The word "SvcCode" is displayed on the second line. The display will cycle every 5 seconds between the currently displayed parameter and the "SvcCode" message until the active service code (DTC) clears. To view the active codes, select the *Service Code Sub-Menu* by pressing the UP or DOWN switch until the top line of the display reads "SvcCode". Then press BOTH the UP and DOWN switches at the same time to select the Service Code

(DTC) Sub-Menu. The diagnostic gauge has the ability to display all active service codes (DTCs) received. The diagram above titled *Service Code (DTC) Sub-Menu* shows the process for selecting active service codes (DTCs) and their values.

NOTE: For a list of Service Codes or Diagnostic Trouble Codes (DTCs) and their causes, refer to TROUBLESHOOTING Section 45, later in this manual. An alternate method of accessing trouble codes for engines for engines without the diagnostic gauge is the blink code method. See Section 45.

Viewing Stored Service Codes/Diagnostic Trouble Codes (DTCs) in the Engine ECU

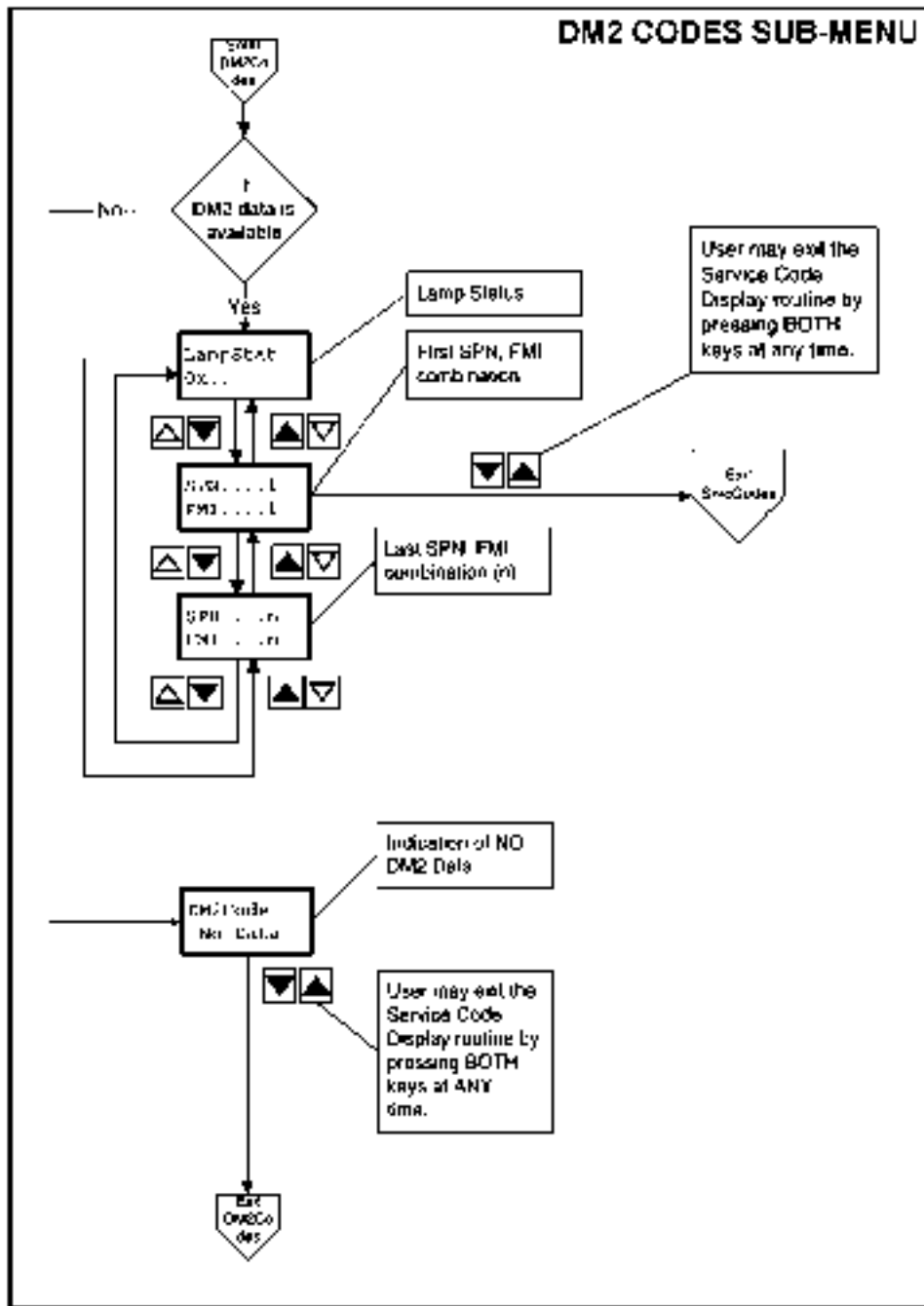

RG10021 -19-28OCT99

Viewing Stored Service Codes/Diagnostic Trouble Codes (DTCs)

The diagnostic gauge can request stored service codes (DTCs) from the engine. The stored service codes may be used for diagnostic and service needs. To view the stored service codes, it is necessary to select the *DM2 Codes Sub-Menu* by pressing the UP

or DOWN switch until the top line of the display reads "DM2 Codes". Then press BOTH the UP and DOWN switches at the same time to select the *DM2 Codes Sub-Menu*. The gauge will display the stored service codes according to the menus shown in the diagram.

Instrument Panel - Elect. Cont. Later Engines

Instrument Panels

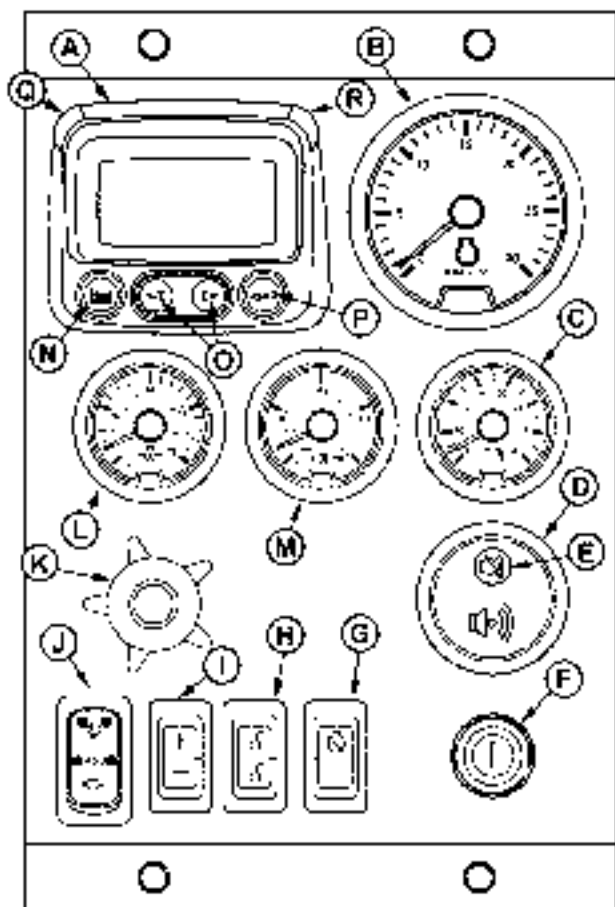

Full-Featured Instrument Panel

RG13276 -UN-28OCT03

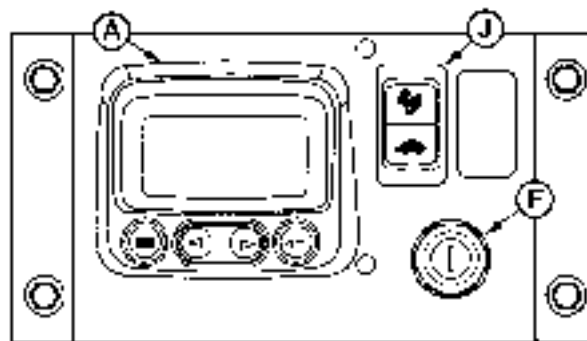

Basic Instrument Panel

RG13277 -UN-22OCT03

A—Diagnostic Gauge/Hour Meter
 B—Tachometer
 C—Voltmeter (Optional)
 D—Audible Alarm (Optional)
 E—Audible Alarm Override Button

F—Key Switch
 G—Override Shutdown Rocker Switch
 H—Bump Enable Rocker Switch
 I—Speed Select Rocker Switch
 J—High-Low Speed Select Rocker Switch

K—Analog Throttle Control (Optional)
 L—Oil Pressure Gauge
 M—Coolant Temperature Gauge
 N—Menu Key

O—Arrow Keys
 P—Enter Key
 Q—Amber “WARNING” Indicator Light
 R—Red “STOP ENGINE” Indicator Light

Later Tier 2 John Deere *POWERTECH™* OEM Engines have an electronic control system, which has the following controls and gauges as shown. The following information applies only to those controls and gauges supplied by John Deere. Refer to your engine application manual for specific guidelines if John Deere-sourced controls and instrumentation are not used.

Following is a brief description of the available optional electronic controls and gauges found on John Deere provided instrument panels. Refer to manufacturer’s literature for information on controls not provided by Deere.

Instrument Panel (Continued)**A—Diagnostic Gauge/Hour Meter**

The diagnostic gauge (A) displays diagnostic trouble codes (DTCs) as they are accessed. Other information on the engine can be accessed using the touch keys (N, O and P). The hour meter feature shows the operating hours of the engine and should be used as a guide for scheduling periodic maintenance. If the diagnostic gauge receives a trouble code from an engine control unit, the current display will switch to a warning or shutdown (depending on the severity of the code) screen that will display the trouble code number, the description of the code and the corrective action needed.

B—Tachometer

The tachometer (B) indicates engine speed in hundreds of revolutions per minute (rpm).

C—Voltmeter (Optional)

The voltmeter (C) indicates system battery voltage. The amber "Warning" light (P) will illuminate when battery voltage is too low for proper operation of the fuel injection system.

D—Audible Alarm (Optional)

The audible alarm (D) will sound whenever low oil pressure, high coolant temperature, or water-in-fuel conditions exist. This includes all signals that light up the amber "warning" indicator (intermittent alarm) or the red "stop engine" indicator (steady alarm).

E—Audible Alarm Override Button

The optional audible alarm has an override button (E) that silences the audible alarm for approximately two minutes when pressed.

F—Key Start Switch

The three-position key start switch (F) controls the engine electrical system. When the key switch is turned clockwise to "START", the engine will crank.

When the engine starts, the key is released and returns to the "ON" (RUN) position.

G—Override Shutdown Rocker Switch

Switch will be present, but may not be active, depending on engine controller (ECU) options originally selected. If switch is active, pressing the upper half of the override shutdown switch (G) will override an engine shutdown signal. The switch must be pressed within 30 seconds to prevent undesired shutdown of engine. Pressing this switch will override the engine shutdown for 30 seconds at a time to move vehicle to a safe location.

H—Bump Speed Enable Rocker Switch

This is a three-position switch (H) with the center position as "OFF" (locked). With this switch in the "OFF" position, the speed select switch (I) is also locked, to prevent accidental changes in operating speed. Pressing upper or lower half of switch (H) will unlock or enable the bump speed switch to take effect using speed select switch (I).

I—Speed Select Rocker Switch

The speed select switch (I) is used to bump engine speed up (+) or down (-) in small increments during operation. This switch must be used with the bump speed enable switch (H) in the unlocked position (top or bottom half of button depressed).

J—High-Low Speed Select Rocker Switch

The high-low speed select switch (J) is used to set the engine operating speeds at slow (turtle) or fast (rabbit). Factory preset idle speeds can also be adjusted using bump speed enable switch (H) with speed select switch (I).

The basic instrument panel will have the high-low speed select switch only. Press and hold up (+) or down (-) to adjust engine speed as desired. The engine speed selected will not be held in the memory. To adjust engine speeds, See Changing Engine Speeds in Section 18.

How To Select Preset Operating Speeds (Bump Speeds)

First select Turtle (Slow) or Adj by pressing speed select switch (J) to "Turtle" (slow) or "Adj"(center). Then you can press either the upper or lower portion of the bump speed enable switch (H) to unlock the setting. The bump speed enable must be held down as the speed select switch (J) is used to change the setting by pressing (+) to increase speed or (-) to decrease speed.

Once the slow idle speed has been set, the bump speed enable **switch must be pressed and released three times within two seconds to commit the new operating speed to memory.** If not done, the engine's new speed will only be effective until the key switch is shut off. Then the speed will revert back to the previous setting.

The fast idle speed is not adjustable. It will always go back to the factory preset fast idle speed.

K—Analog Throttle Control (Optional)

The throttle control (K) is used to control engine speed. This control is available only on engines with analog throttle.

L—Engine Oil Pressure Gauge

The oil pressure gauge (L) indicates engine oil pressure. An audible alarm (E) warns the operator if engine oil pressure falls below a safe operating pressure.

M—Engine Coolant Temperature Gauge

The engine coolant temperature gauge (M) indicates engine coolant temperature. An audible alarm (E)

warns the operator if coolant temperature rises above the preset safe operating temperature.

N—Menu Key

The menu key is pressed to either enter or exit the menu screens on the diagnostic gauge.

O—Arrow Keys

Use the arrow keys (O) to change the display on the window of the diagnostic gauge and to access engine performance data.

Pressing the left arrow to scroll to the left or upward or the right arrow to scroll to the right or downward. This will allow you to view various engine parameters and any diagnostic trouble codes that occur.

Refer to the following story for accessing engine information on the diagnostic gauge using the touch keys.

P—Enter Key

The enter key is pressed to select the parameter that is highlighted on the screen.

Q—Amber "WARNING" Indicator Light

When light comes on, an abnormal condition exists. It is not necessary to shutdown engine immediately, but problem should be corrected as soon as possible.

R—Red "STOP ENGINE" Indicator Light

When light comes on, stop engine immediately or as soon as safely possible to prevent engine damage. Correct problem before restarting.

OURGP11,000027C -19-25NOV03-3/3

Using Diagnostic Gauge to Access Engine Information

The diagnostic gauge (A) allows the operator to view many readouts of engine functions and trouble codes (DTCs). The gauge is linked to the electronic control system and its sensors. This allows the operator to monitor engine functions and to troubleshoot the engine systems when needed.

Press the menu key (B) to access the various engine functions in sequence. The displays can be selected as either customary English or metric units.

The following menu of engine parameters can be displayed on the diagnostic gauge window:

- Engine hours
- Engine rpm
- System voltage
- Percent engine load at the current rpm
- Coolant temperature
- Oil pressure
- Throttle position
- Intake manifold temperature
- Current fuel consumption
- Active service (diagnostic) codes
- Stored service (diagnostic) codes from the engine
- Set the units for display
- View the engine configuration parameters

The diagnostic gauge includes a graphical backlit Liquid Crystal Display (LCD) screen. The display can show either a single parameter or a quadrant display showing four parameters simultaneously. The diagnostic gauge uses two arrow keys (C) for scrolling through the engine parameter list and viewing the menu list and an enter key (D) for selecting highlighted items. The red (E) and amber (F) lights are used to signal active trouble code received by the diagnostic gauge.

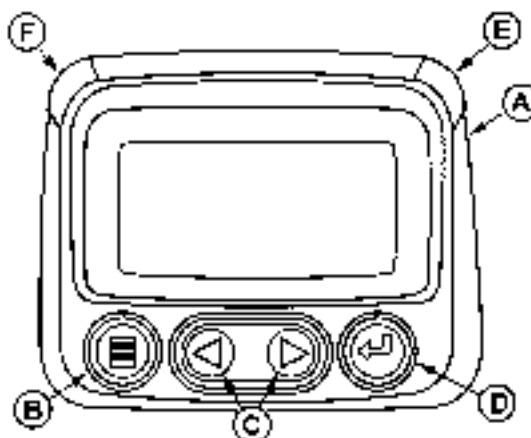

Diagnostic Gauge (Later Engines)

- A—Diagnostic Gauge
- B—Menu Key
- C—Arrow Keys
- D—Enter Key
- E—Red “STOP ENGINE” Indicator Light
- F—Amber “WARNING” Indicator Light

RG13132 -UN-09SEP03

OURGP11,000018D -19-12FEB04-1/1

Main Menu Navigation

NOTE: The engine does not need to be running to navigate the diagnostic gauge screens. If engine start up is desired, See Starting The Engine. All of the engine values illustrated on the diagnostic gauge indicate the engine is running.

1. Turn the key switch to the ON position. Starting at the single or four engine parameter display, press the "Menu" key.

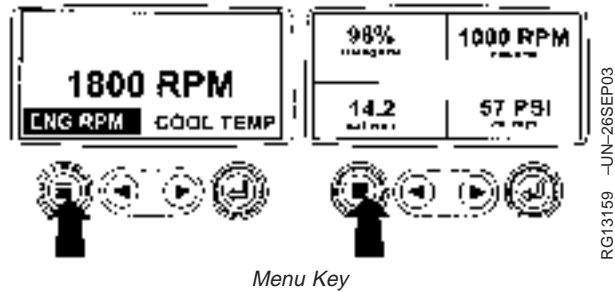

RG13159 -UN-26SEP03

OURGP11,00000A9 -19-03SEP03-1/5

2. The first seven items of the "Main Menu" will be displayed.

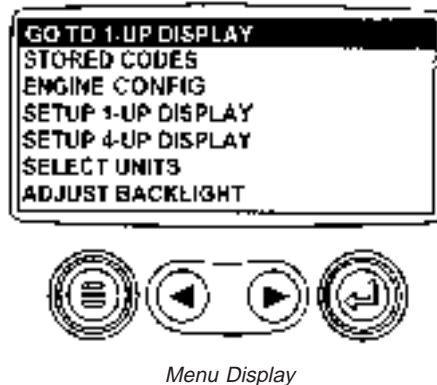

RG13160 -UN-02OCT03

Menu Display

OURGP11,00000A9 -19-03SEP03-2/5

3. Pressing the "Arrow" keys will scroll through the menu selections.

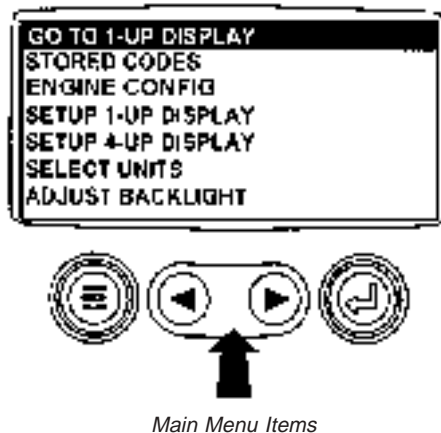

RG13161 -UN-02OCT03

Main Menu Items

Continued on next page

OURGP11,00000A9 -19-03SEP03-3/5

- Pressing the right arrow key will scroll down to reveal the last items of "Main Menu" screen, highlighting the next item down.

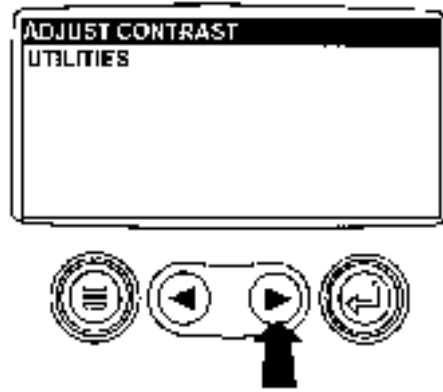

Last Items On Main Menu

RG13162 -UN-26SEP03

OURGP11,00000A9 -19-03SEP03-4/5

- Use the arrow keys to scroll to the desired menu item or press the "Menu Button" to exit the main menu and return to the engine parameter display.

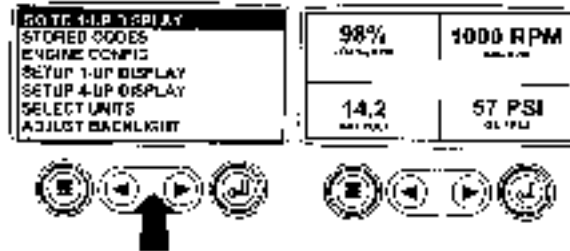

Use Arrow Buttons To Scroll / Quadrant Display

RG13163 -UN-02OCT03

OURGP11,00000A9 -19-03SEP03-5/5

Engine Configuration Data

NOTE: The engine configuration data is a read only function.

NOTE: The engine does not need to be running to navigate the diagnostic gauge screens. If engine start up is desired, See Starting The Engine. All of the engine values illustrated on the diagnostic gauge indicate the engine is running.

- Turn the key switch to the ON position. Starting at the single or four engine parameter display, press the "Menu" key.

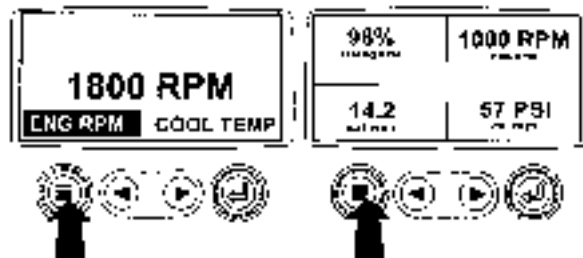

Menu Key

RG13159 -UN-26SEP03

Continued on next page

OURGP11,00000AB -19-03SEP03-1/6

2. The main menu will be displayed. Use the "Arrow" keys to scroll through the menu until "Engine Config" is highlighted.

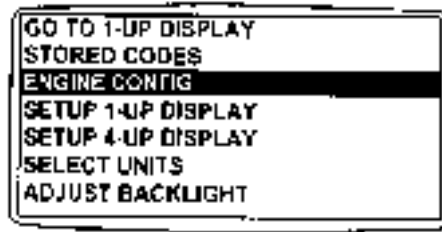

Select Engine Configuration

RG13164 -UN-07OCT03

OURGP11.00000AB -19-03SEP03-2/6

3. Once "Engine Config" menu item has been highlighted, press the "Enter" key to view the engine configuration data.



Enter Key

RG13165 -UN-02OCT03

OURGP11.00000AB -19-03SEP03-3/6

4. Use the "Arrow" keys to scroll through the engine configuration data.

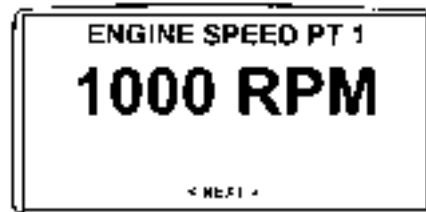

Use Arrow Keys To Scroll

RG13166 -UN-29SEP03

OURGP11.00000AB -19-03SEP03-4/6

5. Press the "Menu" key to return to the main menu.

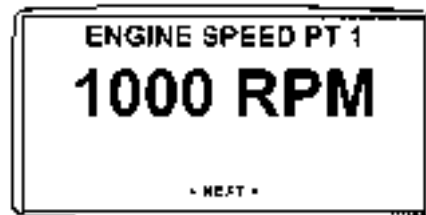

Return To Main Menu

RG13167 -UN-29SEP03

Continued on next page

OURGP11.00000AB -19-03SEP03-5/6

- Press the "Menu" key to exit the main menu and return to the engine parameter display.

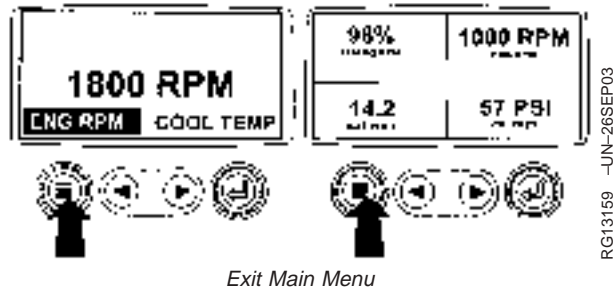

OURGP11.00000AB -19-03SEP03-6/6

Accessing Stored Trouble Codes

NOTE: The engine does not need to be running to navigate the diagnostic gauge screens. If engine start up is desired, See Starting The Engine. All of the engine values illustrated on the diagnostic gauge indicate the engine is running.

For description of trouble codes, see chart in Troubleshooting Section.

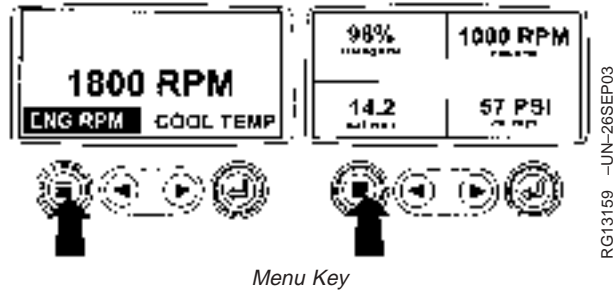

- Turn the key switch to the ON position. Starting at the single or four engine parameter display, press the "Menu" key.

OURGP11.00000AC -19-03SEP03-1/6

- The main menu will be displayed. Use the "Arrow" keys to scroll through the menu until "Stored Codes" is highlighted.

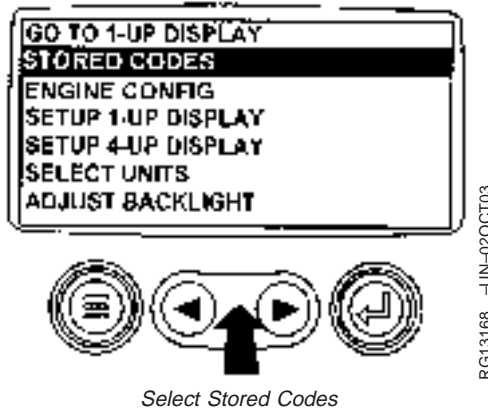

Continued on next page

OURGP11.00000AC -19-03SEP03-2/6

3. Once the "Stored Codes" menu item has been highlighted press the "Enter" key to view the stored codes.

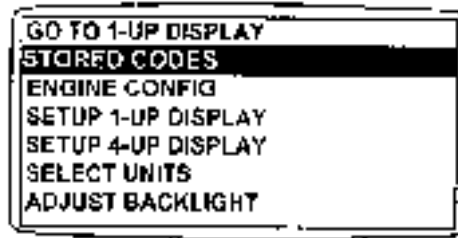

Enter Key

RG13169 -UN-02OCT03

OURGP11,00000AC -19-03SEP03-3/6

4. If the word "Next" appears above the "Arrow" keys, there are more stored codes that may be viewed. Use the "Arrow" key to scroll to the next stored code.

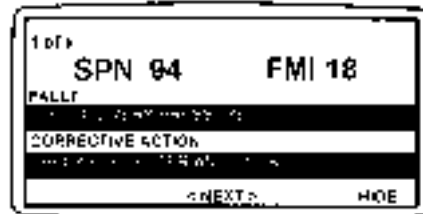

Use Arrow Keys To Scroll

RG13245 -UN-02OCT03

OURGP11,00000AC -19-03SEP03-4/6

5. Press the "Menu" key to return to the main menu.



Return To Main Menu

RG13246 -UN-02OCT03

Continued on next page

OURGP11,00000AC -19-03SEP03-5/6

- Press the "Menu" key to exit the main menu and return to the engine parameter display.

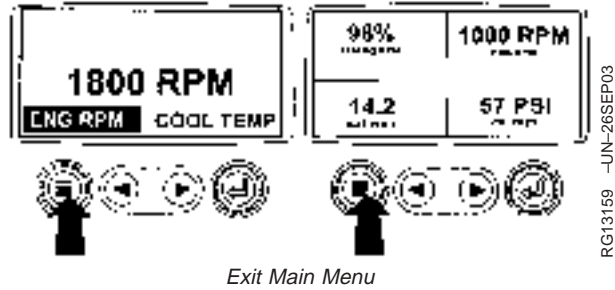

OURGP11.00000AC -19-03SEP03-6/6

Accessing Active Trouble Codes

NOTE: The engine does not need to be running to navigate the diagnostic gauge screens. If engine start up is desired, See Starting The Engine. All of the engine values illustrated on the diagnostic gauge indicate the engine is running.

For description of trouble codes, see chart in Troubleshooting Section.

- During normal operation the single or four parameter screen will be displayed.

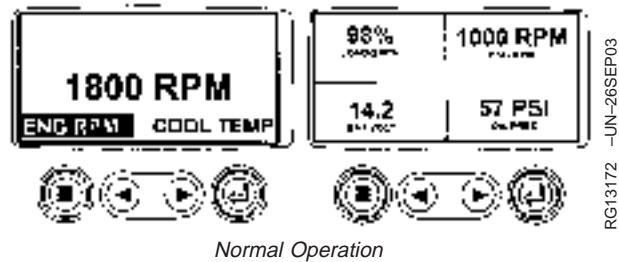

OURGP11.00000AD -19-03SEP03-1/7

- When the diagnostic gauge receives a trouble code from an engine control unit, the single or four parameter screen will be replaced with the "Warning" message. The SPN and FMI number will be displayed along with a description of the problem and the corrective action needed.

IMPORTANT: Ignoring active trouble codes can result in severe engine damage.

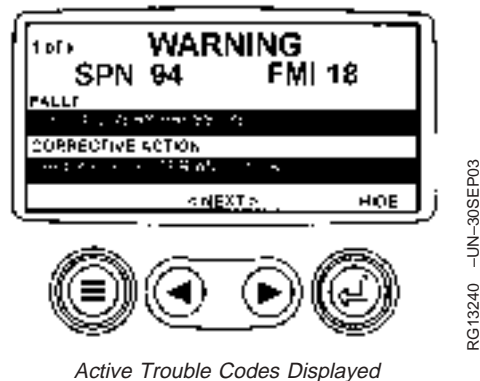

Continued on next page

OURGP11.00000AD -19-03SEP03-2/7

3. If the word "Next" appears above the arrow keys, there are more trouble codes that can be viewed by using the arrow keys to scroll to the next trouble code.



Use Arrow Keys To Scroll

RG13241 -UN-30SEP03

OURGP11.00000AD -19-03SEP03-3/7

IMPORTANT: Ignoring active trouble codes can result in severe engine damage.

4. To acknowledge and hide the code and return to the single or four parameter display, press the "Enter" Key.



Hide Trouble Codes

RG13242 -UN-30SEP03

OURGP11.00000AD -19-03SEP03-4/7

5. The display will return to the single or four parameter display, but the display will contain the warning icon. Pressing the "Enter" key will redisplay the hidden trouble code.

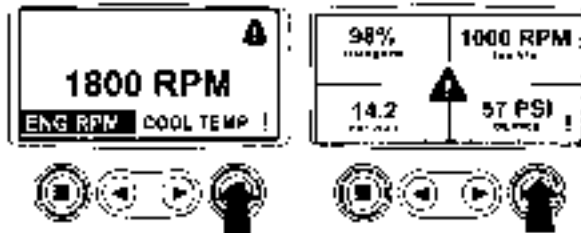

Active Trouble Code Icon

RG13176 -UN-26SEP03

OURGP11.00000AD -19-03SEP03-5/7

IMPORTANT: Ignoring active trouble codes can result in severe engine damage.

6. Pressing the "Enter" key once again will hide the trouble code and return the screen to the single or four parameter display.



Enter Key

RG13242 -UN-30SEP03

Continued on next page

OURGP11.00000AD -19-03SEP03-6/7

- The single or four parameter screen will display the warning icon until the trouble code condition is corrected.

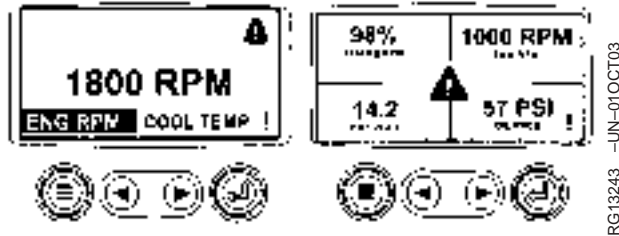

Active Trouble Code Condition

RG13243 -UN-01OCT03

OURGP11.00000AD -19-03SEP03-7/7

Engine Shutdown Codes

- During normal operation the single or four parameter screen will be displayed.

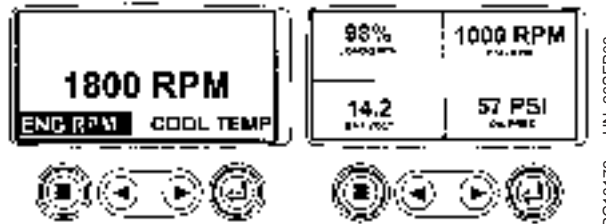

Normal Operation

RG13172 -UN-26SEP03

OURGP11.00000AE -19-03SEP03-1/6

- When the diagnostic gauge receives a severe trouble code from an engine control unit, the single or four parameter screen will be replaced with the "Shutdown" message. The SPN and FMI number will be displayed along with a description of the problem and the corrective action needed.

If the word "Next" appears above the arrow keys, there are more trouble codes that can be viewed by using the arrow keys to scroll to the next trouble code.



Shutdown Message

RG13238 -UN-29SEP03

OURGP11.00000AE -19-03SEP03-2/6

- To acknowledge and hide the trouble code and return to the single or four parameter display, press the "Enter" key.

IMPORTANT: Ignoring the shutdown message can result in severe engine damage.



Hide Trouble Code

RG13239 -UN-29SEP03

Continued on next page

OURGP11.00000AE -19-03SEP03-3/6

- The display will return to the single or four parameter display, but the display will contain the "Shutdown" icon. Pressing the "Enter" key will redisplay the hidden trouble code.

IMPORTANT: Ignoring the shutdown message can result in severe engine damage.

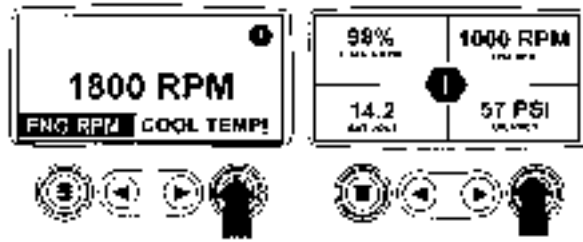

Flashing Shutdown Icon

RG13179 -UN-26SEP03

OURGP11.00000AE -19-03SEP03-4/6

- Pressing the "Enter" key once again will hide the trouble code and return the screen to the single or four parameter display.



Redisplay Trouble Code

RG13239 -UN-28SEP03

OURGP11.00000AE -19-03SEP03-5/6

- The single or four parameter screen will display the shutdown icon until the trouble code condition is corrected.

IMPORTANT: Ignoring the shutdown message can result in severe engine damage.

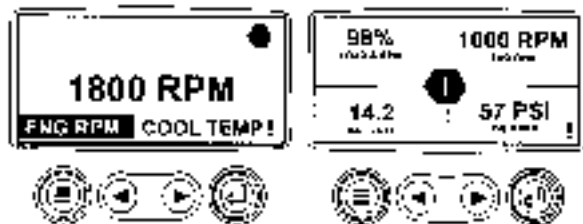

Shutdown Icon

RG13180 -UN-26SEP03

OURGP11.00000AE -19-03SEP03-6/6

Adjusting Backlighting

- Turn the key switch to the ON position. Starting at the single or four engine parameter display, press the "Menu" key.

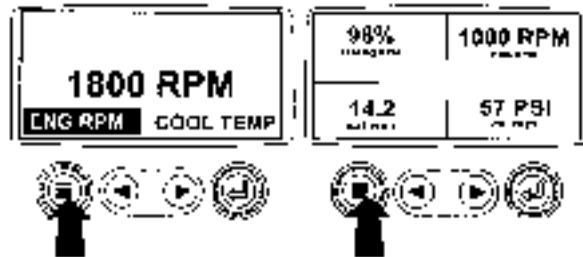

Menu Key

RG13159 -UN-26SEP03

Continued on next page

OURGP11.0000237 -19-21OCT03-1/6

2. The main menu will be displayed. Use the "Arrow" keys to scroll through the menu until "Adjust Backlight" is highlighted.



Select Adjust Backlight

RG13181 -UN-02OCT03

OURGP11,0000237 -19-21OCT03-2/6

3. Once the "Adjust Backlight" menu item has been highlighted, press the "Enter" key to activate the "Adjust Backlight" function.



Press Enter Key

RG13182 -UN-02OCT03

OURGP11,0000237 -19-21OCT03-3/6

4. Use the "Arrow" keys to select the desired backlight intensity.



Adjust Backlight Intensity

RG13183 -UN-29SEP03

Continued on next page OURGP11,0000237 -19-21OCT03-4/6

5. Press the "Menu" key to return to the main menu.



Return To Main Menu

RG13184 -UN-26SEP03

OURGP11,0000237 -19-21OCT03-5/6

6. Press the "Menu" key to exit the main menu and return to the engine parameter display.

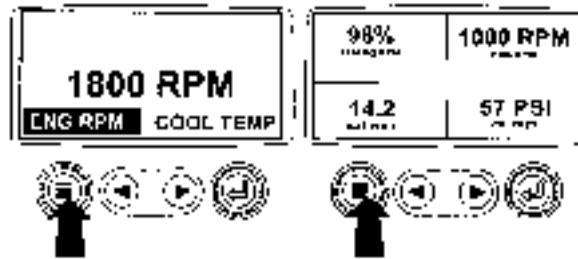

Exit Main Menu

RG13159 -UN-26SEP03

OURGP11,0000237 -19-21OCT03-6/6

Adjusting Contrast

1. Turn the key switch to the ON position. Starting at the single or four engine parameter display press the "Menu" key.

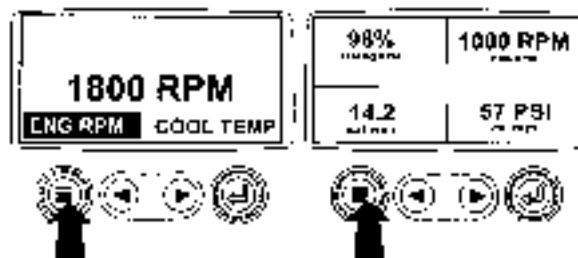

Menu Key

RG13159 -UN-26SEP03

Continued on next page

OURGP11,00000AF -19-03SEP03-1/6

2. The main menu will be displayed. Use the "Arrow" keys to scroll through the menu until "Adjust Contrast" is highlighted.



Select Adjust Contrast

RG13161 -UN-02OCT03

OURGP11,00000AF -19-03SEP03-2/6

3. Once the "Adjust Contrast" menu item has been highlighted, press the "Enter" key to activate the "Adjust Contrast" function.



Press Enter Key

RG13185 -UN-02OCT03

OURGP11,00000AF -19-03SEP03-3/6

4. Use the "Arrow" keys to select the desired contrast intensity.



Adjust Contrast Intensity

Continued on next page

RG13186 -UN-29SEP03

OURGP11,00000AF -19-03SEP03-4/6

5. Press the "Menu" key to return to the main menu.

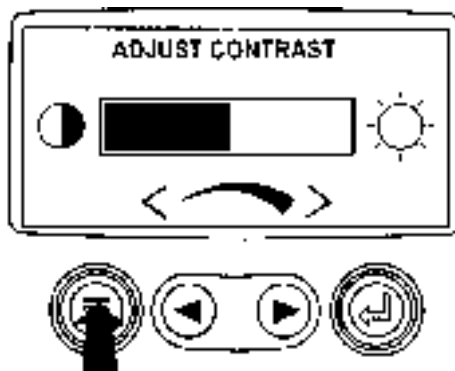

Return To Main Menu

RG13187 -UN-26SEP03

OURGP11,00000AF -19-03SEP03-5/6

6. Press the "Menu" key to exit the main menu and return to the engine parameter display.

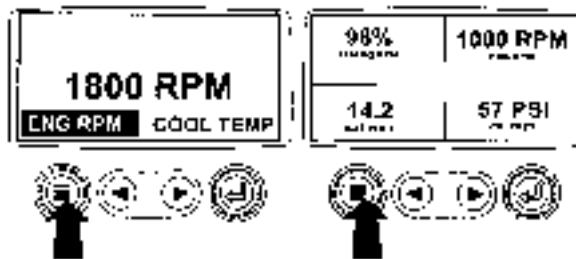

Exit Main Menu

RG13159 -UN-26SEP03

OURGP11,00000AF -19-03SEP03-6/6

Selecting Units Of Measurement

1. Turn the key switch to the ON position. Starting at the single or four engine parameter display, press the "Menu" key.

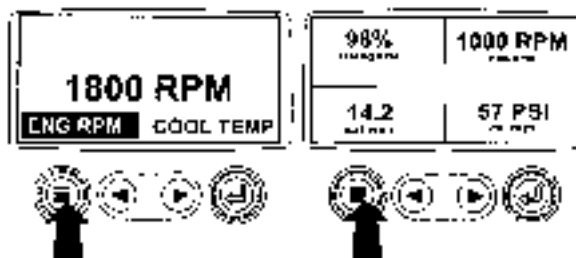

Menu Key

RG13159 -UN-26SEP03

Continued on next page

OURGP11,00000B0 -19-03SEP03-1/7

2. The main menu will be displayed. Use the "Arrow" keys to scroll through the menu until "Select Units" is highlighted.



Select Units

RG13188 -UN-02OCT03

OURGP11,00000B0 -19-03SEP03-2/7

3. Once the "Select Units" menu item has been highlighted press the "Enter" key to access the "Select Units" function.

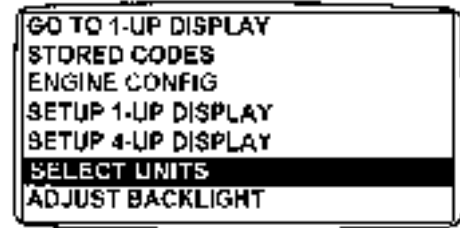

Press Enter Key

RG13188 -UN-02OCT03

OURGP11,00000B0 -19-03SEP03-3/7

4. There are three choices for units of measurement, English, Metric kPa or Metric Bar.

English is for Imperial units, with pressures displayed in PSI and temperatures in °F.

Metric kPa and Metric bar are for IS units, with pressures displayed in kPa and bar respectively, and temperatures in °C.

Use the "Arrow" keys to highlight the desired units of measurement.



Select Desired Units

RG13190 -UN-26SEP03

Continued on next page

OURGP11,00000B0 -19-03SEP03-4/7

5. Press the "Enter" key to select the highlighted units.



OURGP11,00000B0 -19-03SEP03-5/7

6. Press the "Menu" key to return to the main menu.

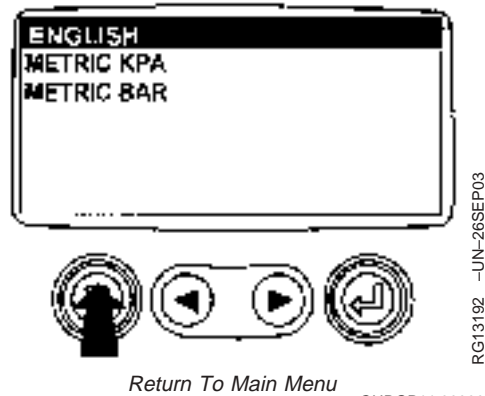

OURGP11,00000B0 -19-03SEP03-6/7

7. Press the "Menu" key to return to the engine parameter display.

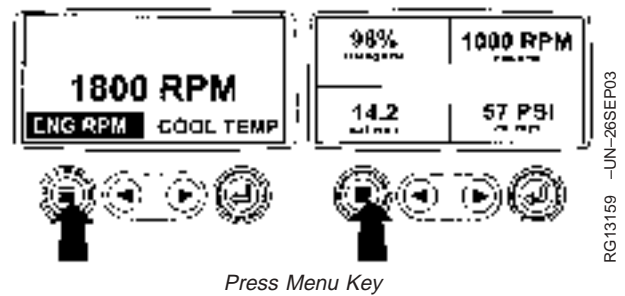

OURGP11,00000B0 -19-03SEP03-7/7

Setup 1-Up Display

1. Turn the key switch to the ON position. Starting at the single engine parameter display, press the "Menu" key.

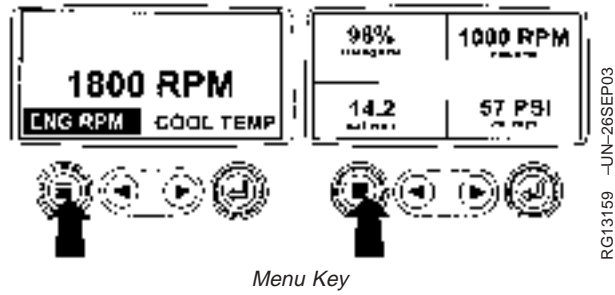

OURGP11,0000B1 -19-03SEP03-1/18

2. Use the "Arrow" keys to scroll through the menu until "Setup 1-Up Display" is highlighted.

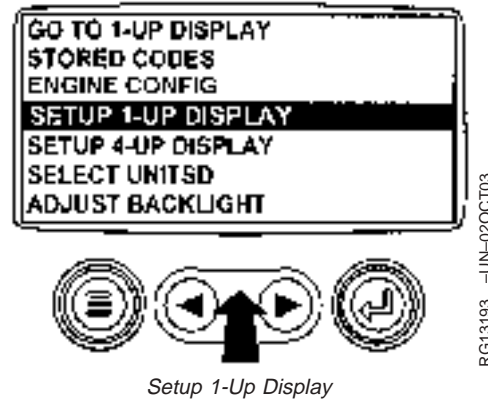

OURGP11,0000B1 -19-03SEP03-2/18

3. Once "Setup 1-Up Display" menu item has been highlighted press the "Enter" key to access the "Setup 1-Up Display" function.

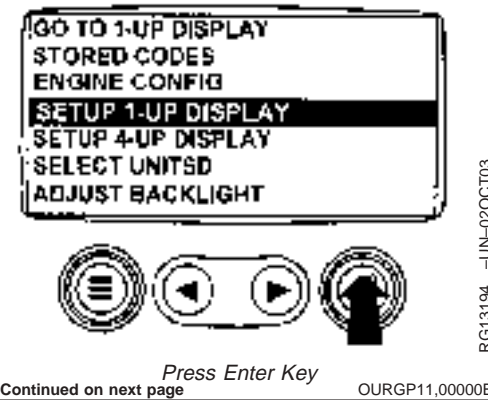

Press Enter Key
Continued on next page

OURGP11,0000B1 -19-03SEP03-3/18

4. Three options are available for modification of the 1-Up Display.

- a. **Use Defaults** – This option contains the following engine parameters for display: Engine Hours, Engine Speed, Battery Voltage, % Load, Coolant Temperature and Oil Pressure.
- b. **Custom Setup** – This option contains a list of engine parameters. Engine parameters from this list can be selected to replace any or all of the default parameters. This option can be used to add parameters available for scrolling in the 1-Up Display.
- c. **Automatic Scan** – Selecting the scan function will allow the 1-Up Display to scroll through the selected set of parameters one at a time, momentarily pausing at each.

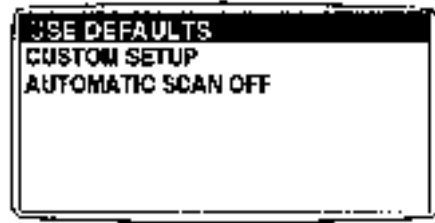

1-Up Display Options

RG13196 -UN-26SEP03

OURGP11,00000B1 -19-03SEP03-4/18

5. **Use Defaults** - To select "Use Defaults" use the Arrow keys to scroll to and highlight "Use Defaults" in the menu display.

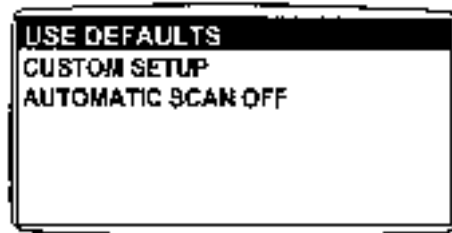

Select Defaults

RG13195 -UN-26SEP03

Continued on next page

OURGP11,00000B1 -19-03SEP03-5/18

6. Press the "Enter" key to activate the "Use Defaults" function.

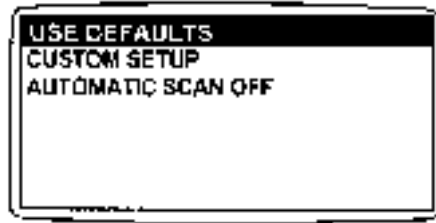

Defaults Selected

RG13197 -UN-29SEP03

OURGP11,00000B1 -19-03SEP03-6/18

7. The display parameters are reset to the factory defaults, then the display will return to the "Setup 1-Up Display" menu.



Restored To Defaults

RG13149 -UN-24SEP03

OURGP11,00000B1 -19-03SEP03-7/18

8. **Custom Setup** - To perform a custom setup of the 1-Up Display, use the arrow buttons to scroll to and highlight "Custom Setup" on the display.

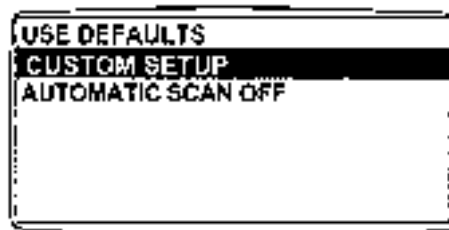

Select Custom Setup

RG13198 -UN-26SEP03

Continued on next page

OURGP11,00000B1 -19-03SEP03-8/18

9. Press the "Enter" key to display a list of engine parameters.

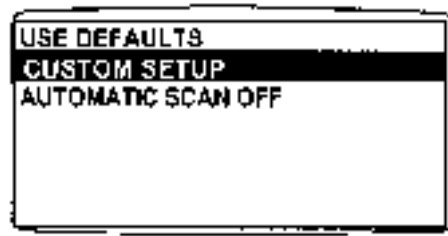

Engine Parameters

RG13199 -UN-26SEP03

OURGP11,00000B1 -19-03SEP03-9/18

10. Use the "Arrow" keys to scroll to and highlight a selected parameter (parameter with a number to right of it).

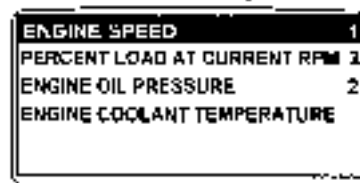

The number indicates the order of the parameters and that the parameters selected for display



Select Parameters

RG13150 -UN-24SEP03

OURGP11,00000B1 -19-03SEP03-10/18

11. Press the "Enter" key to deselect the selected parameter, removing it from the list of parameters being displayed on the 1-Up Display.

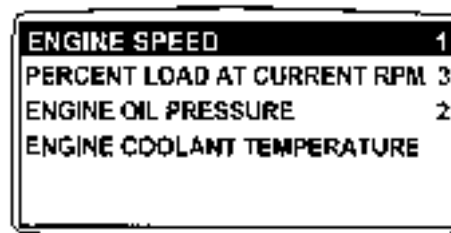

Deselect Parameters

RG13219 -UN-26SEP03

Continued on next page

OURGP11,00000B1 -19-03SEP03-11/18

12. Use the "Arrow" keys to scroll and highlight the desired parameter that has not been selected for display (parameter without a number to right of it).

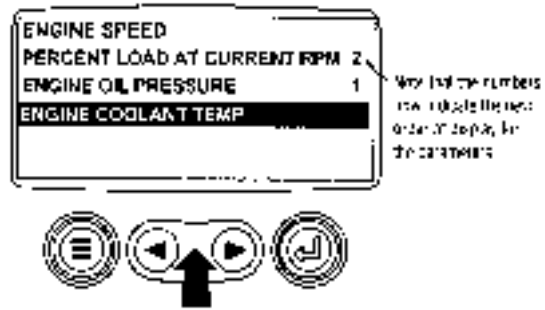

RG13151 -UN-24SEP03

Select Desired Parameters

OURGP11.00000B1 -19-03SEP03-12/18

13. Press the "Enter" key to select the parameter for inclusion in the Single Engine Parameter Display.
14. Continue to scroll through and select additional parameters for the custom 1-Up Display. Press the "Menu" key at any time to return to the "Custom Setup" menu.

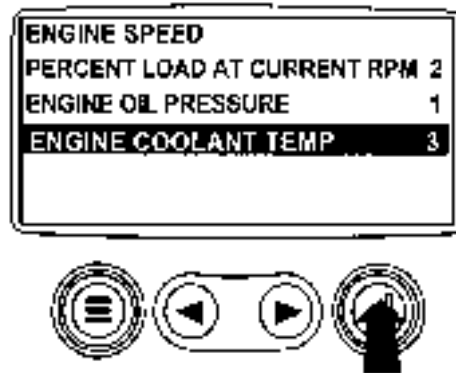

RG13220 -UN-26SEP03

Select Parameters For Display

OURGP11.00000B1 -19-03SEP03-13/18

15. **Automatic Scan** - Selecting the scan function will allow the 1- Up Display to scroll through the selected set of parameters one at a time. Use the "Arrow" keys to scroll to the "Automatic Scan" function.

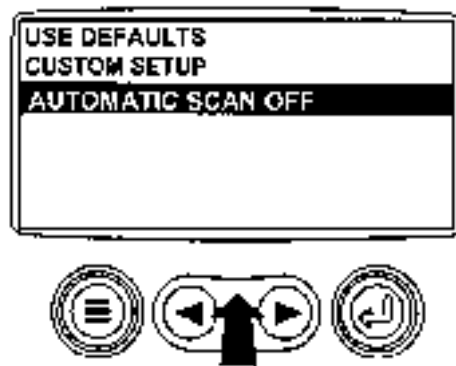

RG13221 -UN-26SEP03

Automatic Scan Off

Continued on next page

OURGP11.00000B1 -19-03SEP03-14/18

16. Press the "Enter" key to toggle the "Automatic Scan" function on.

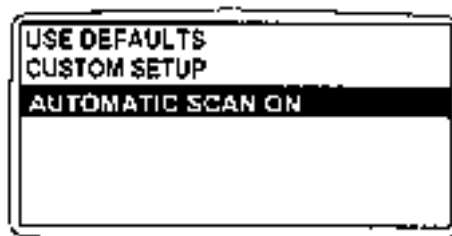

Automatic Scan On

RG13222 -UN-26SEP03

OURGP11,00000B1 -19-03SEP03-15/18

17. Press the "Enter" key again to toggle the "Automatic Scan" function off.

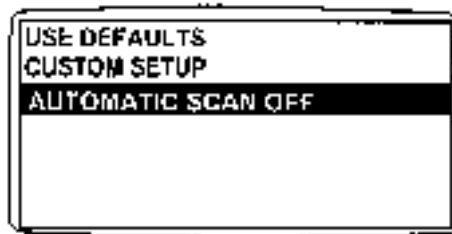

Automatic Scan Off

RG13223 -UN-26SEP03

Continued on next page

OURGP11,00000B1 -19-03SEP03-16/18

18. Once the "Use Defaults", "Custom Setup" and "Automatic Scan" functions have been set, press the "Menu" key to return to the main menu.

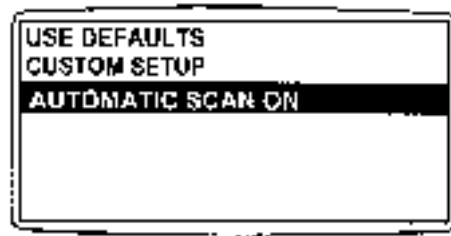

Menu Key

RG13224 -UN-26SEP03

OURGP11,00000B1 -19-03SEP03-17/18

19. Press the "Menu" key to exit the main menu and return to the engine parameter display.

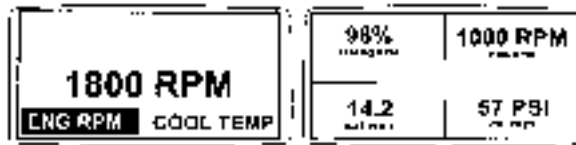

Exit Main Menu

RG13159 -UN-26SEP03

OURGP11,00000B1 -19-03SEP03-18/18

Setup 4-Up Display

1. Turn the key switch to the ON position. From the single or four engine parameter display, press the "Menu" key.

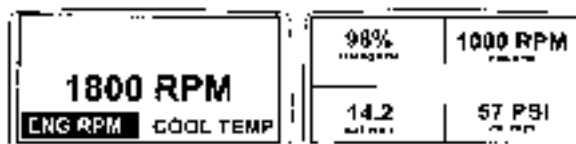

Menu Key

RG13159 -UN-26SEP03

Continued on next page

OURGP11,00000B2 -19-03SEP03-1/14

2. The main menu will be displayed. Use the "Arrow" keys to scroll through the menu until "Setup 4-Up Display" is highlighted.

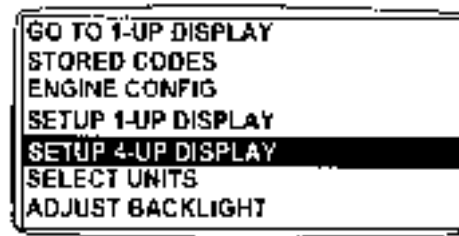

Select Setup 4-Up Display

RG13225 -UN-02OCT03

OURGP11,0000B2 -19-03SEP03-2/14

3. Once the "Setup 4-Up Display" menu item has been highlighted, press the "Enter" key to activate the "Setup 4-Up Display" menu.

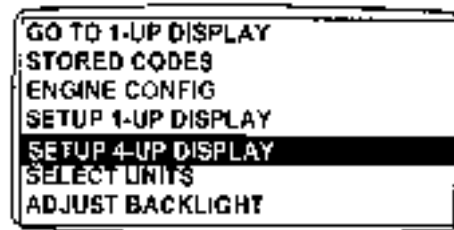

Press Enter Key

RG13226 -UN-02OCT03

Continued on next page

OURGP11,0000B2 -19-03SEP03-3/14

4. Two options are available for the 4-Up Display.

- a. **Use Defaults** – This option contains the following engine parameters for display: Engine Speed, Battery Voltage, Coolant Temperature and Oil Pressure.
- b. **Custom Setup** – This option contains a list of engine parameters. Engine parameters from this list can be selected to replace any or all of the default parameters.

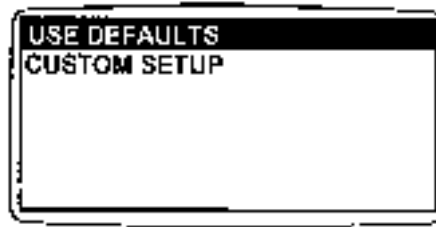

Select Factory Defaults

RG13244 -UN-02OCT03

OURGP11,00000B2 -19-03SEP03-4/14

5. To reset the display parameters to the factory defaults, scroll to and highlight "Use Defaults". Press the "Enter" key to activate the "Use Defaults" function. A message indicating the display parameters are reset to the factory defaults will be displayed, then the display will return to the "Setup 4-Up Display" menu.

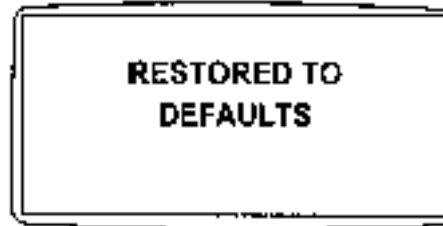

Restored To Defaults

RG13149 -UN-24SEP03

OURGP11,00000B2 -19-03SEP03-5/14

6. **Custom Setup** - To perform a custom setup of the 4-Up Display, use the arrow buttons to scroll to and highlight "Custom Setup" on the display.

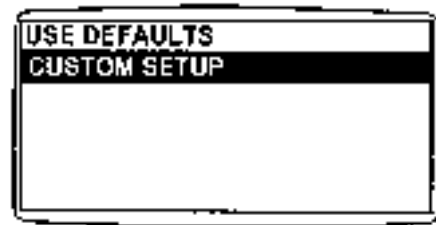

Custom Setup

RG13227 -UN-26SEP03

Continued on next page

OURGP11,00000B2 -19-03SEP03-6/14

7. The quadrant with the highlighted parameter value is the current selected parameter. Use the "Arrow" keys to highlight the value in the quadrant you wish to change to a new parameter.

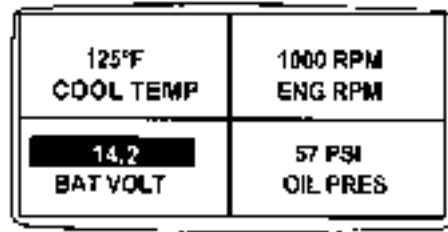

Select Parameters

RG13228 -UN-26SEP03

OURGP11,0000B2 -19-03SEP03-7/14

8. Press the "Enter" key and a list of engine parameters will be displayed.

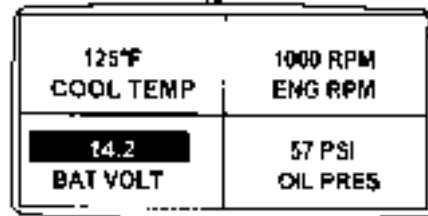

List Of Engine Parameters

RG13229 -UN-26SEP03

OURGP11,0000B2 -19-03SEP03-8/14

9. The parameter that is highlighted is the selected parameter for the screen. Use the "arrow" keys to highlight the new parameter to be placed in the "4-Up Display".



The numbers to the right of the parameter indicate the position of each parameter in the 4-Up Display.



Select Desired Engine Parameter

RG13230 -UN-26SEP03

Continued on next page

OURGP11,0000B2 -19-03SEP03-9/14

10. Press the "Enter" key to change the selected parameter in the quadrant to the new parameter.

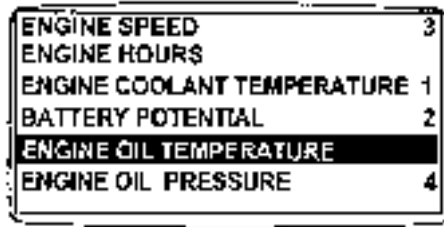

Enter Selected Parameter

RG13231 -UN-26SEP03

OURGP11.00000B2 -19-03SEP03-10/14

11. Use the "Menu" keys to return to the "4-Up Custom Setup" screen.



Push the number to the right of the selected parameter to bring the parameter you assigned to that display back to



Return To 4-Up Custom Setup

RG13232 -UN-26SEP03

OURGP11.00000B2 -19-03SEP03-11/14

12. The selected quadrant has now changed to the new selected parameter.

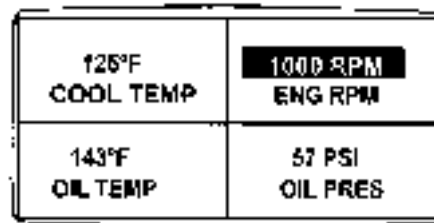

4-Up Display

RG13153 -UN-24SEP03

Continued on next page

OURGP11.00000B2 -19-03SEP03-12/14

13. Repeat the parameter selection process until all spaces are as desired.
14. Press the "Menu" key to return to the main menu.

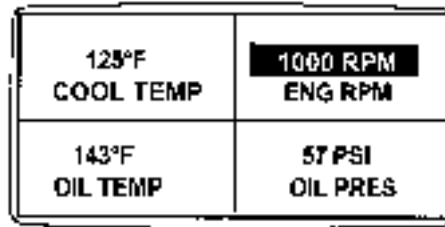

Return To Main Menu

RG13154 -UN-24SEP03

OURGP11,00000B2 -19-03SEP03-13/14

15. Press the "Menu" key to exit the main menu and return to the engine parameter display.

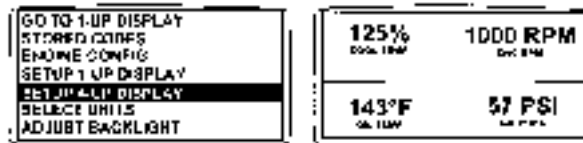

Select Remaining Parameters

RG13155 -UN-07OCT03

OURGP11,00000B2 -19-03SEP03-14/14

Instrument Panel - Mech. Cont. "270" Engines

Instrument Panel (Earlier 4.5 L "270" Engines)

All controls and gauges are optional equipment for John Deere 4.5 L suffix "270" OEM Engines. They may be provided by the equipment manufacturer instead of John Deere.

IMPORTANT: Any time an electric gauge or meter does not register correctly, replace it with a new one. Do not attempt to repair it.

Following is a brief description of the components on a basic instrument (gauge) panel:

A—Tachometer with Hourmeter - The optional tachometer with hourmeter indicates engine speed in revolutions per minute (rpm) and shows the operating hours of the engine while key switch is in the "ON" position. The hour meter should be used as a guide for scheduling periodic service.

B—Coolant Temperature Gauge - The coolant temperature gauge indicates the engine coolant temperature. It is connected to a warning lamp to warn the operator if coolant temperature rises above the preset, safe operating temperature.

C—Oil Pressure Gauge - The oil pressure gauge indicates engine oil pressure. It is connected to a warning lamp to warn the operator if engine oil pressure falls below a safe operating pressure.

D—Pre-Heat Indicator Lamp - This indicator lamp is initially turned on when the key switch is turned to the "HEAT" position to activate the preheater for cold weather starting. Lamp is connected to a timer that turns the lamp off after 15 seconds when the key switch is held at "HEAT" position. When the lamp goes out, start the engine.

E—Charge Indicator Lamp - Indicates whether the charging circuit is adequately replacing battery voltage as it is used by the electrical system. If the lamp is lit while the engine is running above 1300 rpm, stop engine immediately and check charging circuit.

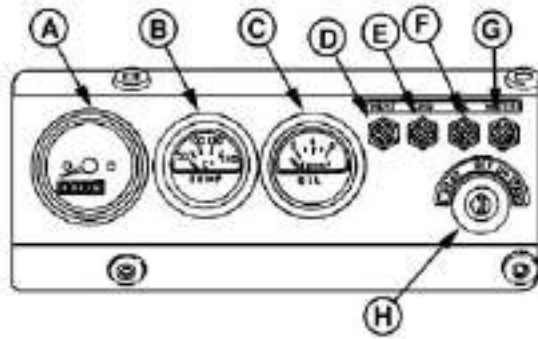

Instrument Panel and Gauges (Earlier 4.5 L "270" Engines)

- A—Tachometer with Hourmeter
- B—Coolant Temperature Gauge
- C—Oil Pressure Gauge
- D—Pre-Heat Indicator Lamp
- E—Charge Indicator Lamp
- F—Oil Pressure Indicator Lamp
- G—Coolant Temperature Indicator Lamp
- H—Key Switch

RG6574A -UN-07-JAN03

Continued on next page

OURGP11,000018E -19-12FEB04-1/2

F—Oil Pressure Indicator Lamp - Warns operator that engine oil pressure is below a safe operating level. If lamp stays lit while engine is running faster than slow idle, stop engine immediately and check engine oil level.

G—Coolant Temperature Indicator Lamp - Warns operator that engine coolant temperature exceeds safe operating level. If lamp is lit during full load operation, the engine is overheated. Stop engine and immediately check fan belt tension and coolant level in radiator.

H—Key Switch - The key switch controls the electrical system. Positions of key switch are marked as follows: OFF, ON, and START. There is also a HEAT position for cold weather starting.

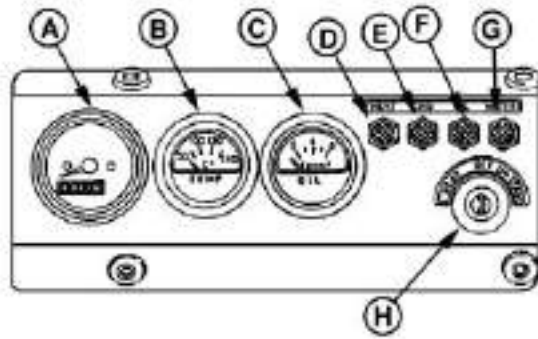

Instrument Panel and Gauges (4.5 L "270" Engines)

RG6574A -UN-07-JAN03

OURGP11,000018E -19-12FEB04-2/2

Instrument Panel (Later 4.5 L "270" Engines)

All controls and gauges are optional equipment for John Deere 4.5 L suffix "270" OEM Engines. They may be provided by the equipment manufacturer instead of John Deere.

IMPORTANT: Any time an electric gauge or meter does not register correctly, replace it with a new one. Do not attempt to repair it.

Following is a brief description of the components on a basic instrument (gauge) panel:

A—Tachometer with Hourmeter (Optional) - The tachometer with hourmeter indicates engine speed in revolutions per minute (rpm) and shows the operating hours of the engine while key switch is in the "ON" position. The hour meter should be used as a guide for scheduling periodic service.

B—Oil Pressure Gauge - The oil pressure gauge indicates engine oil pressure. If the engine oil pressure falls below a safe operating pressure, the engine will shut down.

C—Voltmeter Gauge - The voltmeter indicates system battery voltage.

D—Coolant Temperature Gauge - The coolant temperature gauge indicates the engine coolant temperature. If coolant temperature rises above the preset, safe operating temperature, the engine will shut down.

E—Pre-Heat Button - Press button to activate the preheater for cold weather starting.

F—Reset (Safety) Switch- Reset button will pop out and shut down the engine if the coolant temperature is too high or oil pressure is too low. Press in and hold while starting engine until oil pressure is at a safe operating level.

G—Fuse Holder - Contains 14 amp fuse.

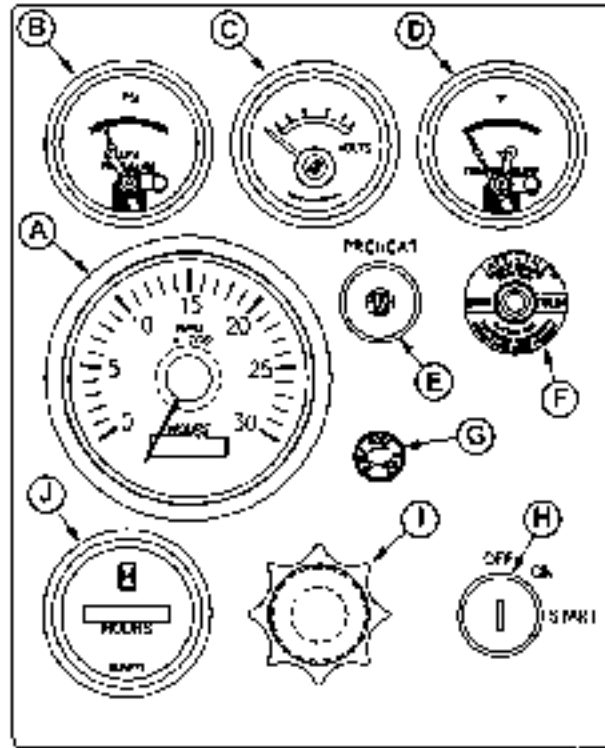

Instrument Panel and Gauges (Later 4.5 L "270" Engines)

- A—Tachometer with Hourmeter (Optional)
- B—Oil Pressure Gauge
- C—Voltmeter Gauge
- D—Coolant Temperature Gauge
- E—Preheat Button
- F—Reset (Safety) Switch
- G—Fuse Holder
- H—Key Switch
- I—Throttle (Optional)
- J—Hourmeter (Optional)

RG13360 -JUN-06FEB04

H—Key Switch - The key switch controls the electrical system. Positions of key switch are marked as follows: OFF, ON, and START.

I—Throttle (Optional) - The throttle control is used to control engine speed.

J—Hourmeter (Optional) - The hourmeter indicates the operating hours of the engine while key switch is in the "ON" position. The hour meter should be used as a guide for scheduling periodic service.

OURGP11,0000160 -19-05FEB04-2/2

Engine Operation - Except 4.5L "270" Engines

Engine Break-In Service

The engine is ready for normal operation. However, extra care during the first 100 hours of operation will result in more satisfactory long-term engine performance and life. DO NOT exceed 100 hours of operation with break-in oil.

1. This engine is factory-filled with John Deere ENGINE BREAK-IN OIL (SAE 10W-30). Operate the engine at heavy loads with minimal idling during the break-in period.
2. If the engine has significant operating time at idle, constant speeds, and/or light load usage, or makeup oil is required in the first 100 hour period, a longer break-in period may be required. In these situations, an additional 100 hour break-in period is recommended using a new change of John Deere ENGINE BREAK-IN OIL and a new John Deere oil filter.



RG8009 -UN-06/JAN99

Check Engine Oil

Continued on next page

OURGP11,0000135 -19-20NOV03-1/4

RG8028A -UN-15JAN99

IMPORTANT: DO NOT add makeup oil until the oil level is BELOW the ADD mark on dipstick. John Deere ENGINE BREAK-IN OIL (TY22041) should be used to make up any oil consumed during the break-in period.

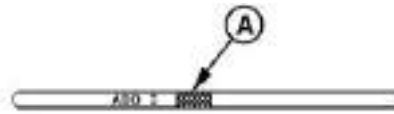

Crosshatch Pattern On Dipstick

A—Crosshatch Pattern On Dipstick

3. Check engine oil level more frequently during engine break-in period. If oil must be added during this period, John Deere ENGINE BREAK-IN OIL is preferred. See ENGINE BREAK-IN OIL, in Fuels, Lubricants, and Coolant Section.

IMPORTANT: DO NOT use PLUS-50™ Engine Oil or engine oils meeting API CG4, API CF4, ACEA E3, ACEA E2, API CI-4, ACEA E5, API CH-4 or ACEA E4 performance levels during the first 100 hours of operation of a new or rebuilt engine. These oils will not allow a new or rebuilt engine to break-in properly.

DO NOT fill above the crosshatch pattern (A) or the FULL mark, whichever is present. Oil levels anywhere within the crosshatch are considered in the acceptable operating range.

Specification

Engine ¹ —Oil Pressure at Full Load Rated Speed	345 ± 103 kPa (3.45 ± 1.03 bar)
	(50 ± 15 psi)
Minimum Oil Pressure at 850 rpm	105 kPa (1.05 bar) (15 psi)
Coolant Temperature Range.....	82°–94°C (180°–202°F)

¹At normal operating temperature of 115°C (240°F) oil sump.

Continued on next page

OURGP11,0000135 -19-20NOV03-2/4

4. During the first 20 hours, avoid prolonged periods of engine idling or sustained maximum load operation. If engine will idle longer than 5 minutes, stop engine.
5. Before the first 100 hours (maximum), change engine oil and replace engine oil filter (A). (See CHANGING ENGINE OIL AND REPLACING FILTER in Lubrication and Maintenance/500 Hour/12 Month Section.) Fill crankcase with seasonal viscosity grade oil. (See DIESEL ENGINE OIL, in Fuels, Lubricants, and Coolant Section.)



Engine Oil Filter

A—Engine Oil Filter

NOTE: Some increase in oil consumption may be expected when low viscosity oils are used. Check oil levels more frequently.

If air temperature is below -10°C (14°F), use an engine block heater.

RG11616 -JUN-24OCT01

OURGP11,0000135 -19-20NOV03-3/4

6. Watch coolant temperature gauge (A) closely. If coolant temperature rises above 112°C (234°F), reduce load on engine. Unless temperature drops quickly, stop the engine and determine the cause before resuming operation.

NOTE: When the coolant temperature gauge reads approximately 115°C (239°F), the engine will shutdown automatically, if equipped with safety controls.

7. Check poly-vee belt for proper alignment and seating in pulley grooves.

A—Engine Coolant Temperature Gauge



Watch Coolant Temperatures On Earlier Panel (Left) or Later Panel (Right)

RG13278 -JUN-30OCT03

OURGP11,0000135 -19-20NOV03-4/4

Starting the Engine

The following instructions apply to the optional controls and instruments available through the John Deere Parts Distribution Network. The controls and instruments for your engine may be different from those shown here; always follow manufacturer's instructions.

 **CAUTION:** Before starting engine in a confined building, install proper outlet exhaust ventilation equipment. Always use safety approved fuel storage and piping.

NOTE: If temperature is below 0°C (32°F), it may be necessary to use cold weather starting aids (See COLD WEATHER OPERATION, later in this section).

1. Perform all prestarting checks outlined in Lubrication & Maintenance/Daily Section later in this manual.
2. Open the fuel supply shut-off valve, if equipped.
3. Disengage clutch (if equipped) controlling any engine drivelines.



Use Proper Ventilation

TSS220 -JUN-23AUG88

Continued on next page

OURGP11,0000136 -19-20NOV03-1/3

4. Set slow idle as follows:

Panels with high-low speed select rocker switch (B) only: Set slow speed by pressing lower half of switch.

Panels with optional analog throttle(s) (A) : Set high-low speed select rocker switch to slow (turtle), then push in on analog throttle handle or turn full counterclockwise to set analog throttle(s) to slow speed.

IMPORTANT: Do not operate the starter for more than 30 seconds at a time. To do so may overheat the starter. If the engine does not start the first time, wait at least 2 minutes before trying again. If engine does not start after four attempts, see Troubleshooting section.



RG13279 -JUN-30OCT03

Analog Throttle Control and Speed Select Switch On Earlier Panel (Left) or Later Panel (Right)

A—Analog Throttle Control (Optional)
B—Speed Select Rocker Switch

Continued on next page

OURGP11,0000136 -19-20NOV03-2/3

- Turn the key start switch (A) clockwise to crank the engine. When the engine starts, release the key switch so that it returns to the "ON" position.

IMPORTANT: If the key switch is released before the engine starts, wait until the starter and the engine stop turning before trying again. This will prevent possible damage to the starter and/or flywheel.

- After engine starts, idle engine at not more than 1200 rpm until warm. (See WARMING ENGINE later in this section).

Panels with high-low speed select rocker switch (B) only: Set rpm using bump speed enable switch (C) with speed select rocker switch (D).

Panels with optional analog throttle (E): Set either high-low speed select switch (B) or analog throttle (E) to slow speed, and set desired speed with remaining control.

NOTE: Engine control unit (ECU) reads the higher of the high-low speed select rocker switch or the analog throttle speed settings.

- Check all gauges for normal engine operation. If operation is not normal, stop the engine and determine the cause. (For normal gauge pressures and temperatures, see BREAK-IN SERVICE earlier in this section.)

NOTE: Hand throttle (A) may have an analog potentiometer for changing engine speeds (See "Changing Engine Speeds" later in this section).

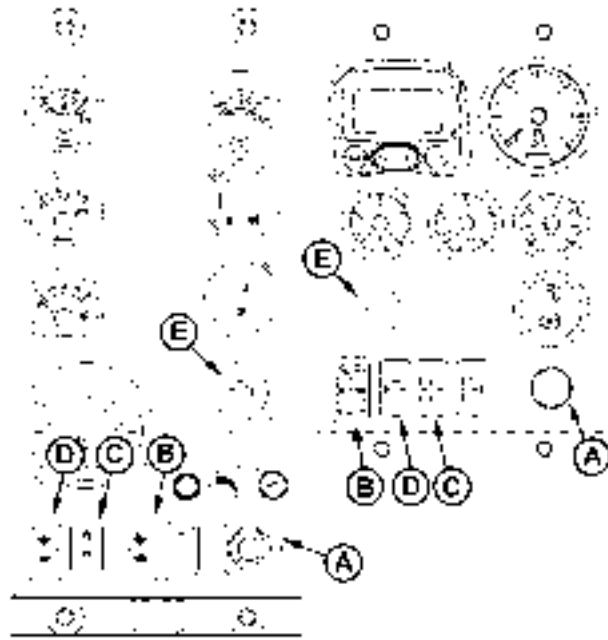

Start And Idle Engine On Earlier Panel (Left) or Later Panel (Right)

- A—Key Start Switch
- B—High-Low Speed Select Rocker Switch
- C—Bump Speed Enable Rocker Switch
- D—Speed Select Rocker Switch
- E—Analog Throttle Control (Optional)

RG13280 -JUN-30OCT03

Normal Engine Operation

Observe engine coolant temperature and engine oil pressure. Temperatures and pressures will vary between engines and with changing operating conditions, temperatures, and loads.

Normal engine coolant operating temperature range is 82°—94°C (180°—202°F). If coolant temperature rises above 112°C (234°F), reduce load on engine. Unless temperature drops quickly, stop engine and determine cause before resuming operation.

Operate the engine under a lighter load and at slower than normal speed for first 15 minutes after start-up. DO NOT run engine at slow idle.

IMPORTANT: Should the engine die while operating under load, immediately

remove load and restart the engine. Overheating of the turbocharger parts may occur when oil flow is stopped.

Stop engine immediately if there are any signs of part failure. Symptoms that may be early signs of engine problems are:

- Sudden drop in oil pressure
- Abnormal coolant temperatures
- Unusual noise or vibration
- Sudden loss of power
- Excessive black exhaust
- Excessive fuel consumption
- Excessive oil consumption
- Fluid leaks

RG, RG34710, 5552 -19-20MAY96-1/1

Warming Engine

The electronically-controlled engines will operate at an accelerated slow idle of 1050 rpm until the engine coolant warms up to 20° C (68° F).

IMPORTANT: To assure proper lubrication, operate engine at or below 1200 rpm with no load for 1–2 minutes. Extend this period 2–4 minutes when operating at temperatures below freezing.

Engines used in generator set applications where the governor is locked at a specified speed may not have a slow idle function. Operate these engines at high idle for 1 to 2 minutes before applying the load. This procedure does not apply to standby generator sets where the engine is loaded immediately upon reaching rated speed.

1. Check oil pressure gauge (A) as soon as engine starts. If gauge needle does not rise above minimum oil pressure specification of 105 kPa (1.05 bar) (15.0 psi) within 5 seconds, stop the engine and determine the cause. Normal engine oil pressure is 345 ± 103 kPa (3.45 ± 1.03 bar) (50 ± 15 psi) at rated full load speed (1800–2500 rpm) with oil at normal operating temperature of 115°C (240°F).

NOTE: On certain engines, the oil pressure and coolant temperature gauges are replaced by indicator warning lights. The lights must be "OFF" when engine is running.

2. Watch coolant temperature gauge (B). Do not place engine under full load until it is properly warmed up. The normal engine coolant temperature range is 82°—94°C (180°—202°F).

NOTE: It is a good practice to operate the engine under a lighter load and at lower speeds than normal for the first few minutes after start-up.

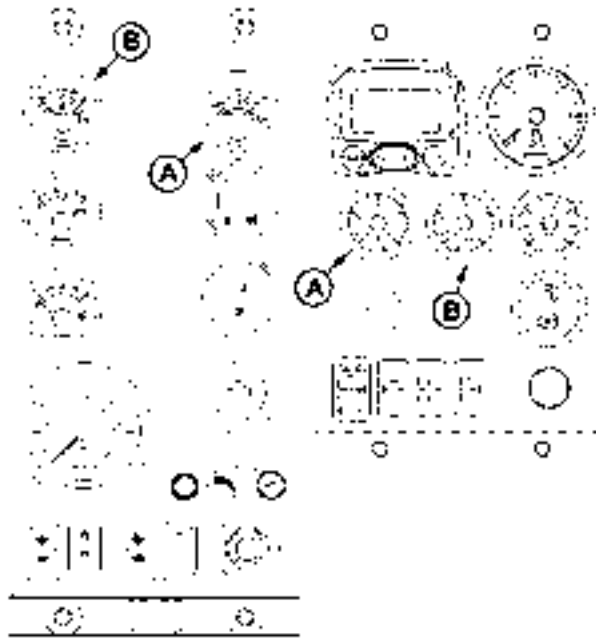

Oil Pressure and Coolant Temperature Gauges On Earlier Panel (Left) or Later Panel (Right)

A—Engine Oil Pressure Gauge
B—Engine Coolant Temperature Gauge

RG13281 -JUN-30OCT03

Cold Weather Operation

CAUTION: DO NOT use starting fluid on engines equipped with air intake heaters or glow plugs. Ether injector starting fluid is highly flammable and may explode, causing serious injury.

DO NOT use starting fluid near fire, sparks, or flames. DO NOT incinerate or puncture a starting fluid container.

Engines may be equipped with intake air heaters, coolant heaters, fuel heaters, or ether injectors as cold weather starting aids. Later "475" 4-valve cylinder head engines are equipped with glow plugs as an automatic cold weather starting aid.

Starting aids are required below 0°C (32°F). They will enhance starting performance above these temperatures and may be needed to start applications that have high parasitic loads during cranking and/or start acceleration to idle.

Using correct grade of oil (per engine and machine operator's manual) is critical to achieving adequate cold weather cranking speed.

Other cold weather starting aids are required at temperatures below -30°C (-22°F) or at altitudes above 1500 m (5000 ft).

1. Follow steps 1—4 as listed under STARTING THE ENGINE, earlier in this section, then proceed as follows according to the instrument (gauge) panel on your engine.
2. **275-Series Engines Without Air Intake Heaters:**
Manually activate ether injectors.



Handle Starting Fluid with Care

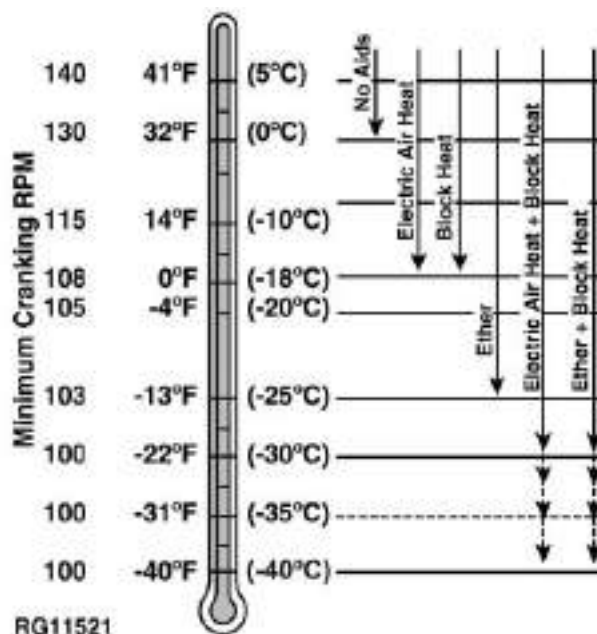

Cold Weather Starting Guidelines

T51356 -UN-18MAR92

RG11521 -19-10JAN01

Continued on next page

RG, RG34710, 5050 -19-25FEB03-1/2

NOTE: Air intake heaters (275 engines) and glow plugs (475 engines) operate automatically through the ECU. The Engine Preheater Indicator light on these engines, located above the key switch, should always illuminate when the switch is turned ON. In warm weather, the light illuminates briefly as a light check. In cold weather, the light remains on during the automatic operation of the air intake heater or glow plugs. Operating time depends on temperature. Do not crank engine until light turns off.

275-Series Engines with Air Intake Heaters and 475-Series Engines with Glow Plugs: Turn key ON, but DO NOT crank engine until Engine Preheater Indicator light turns off.

3. Follow remaining steps 5—6 as listed under earlier in this section.

Additional information on cold weather operation is available from your authorized servicing dealer.

RG.RG34710,5050 -19-25FEB03-2/2

Using a Booster Battery or Charger

A 12-volt booster battery can be connected in parallel with battery (ies) on the unit to aid in cold weather starting. ALWAYS use heavy duty jumper cables.

CAUTION: Gas given off by battery is explosive. Keep sparks and flames away from battery. Before connecting or disconnecting a battery charger, turn charger off. Make last connection and first disconnection at a point away from battery. Always connect **NEGATIVE (-)** cable last and disconnect this cable first.

WARNING: Battery posts, terminals, and related accessories contain lead and lead compounds, chemicals known to the State of California to cause cancer and reproductive harm. Wash hands after handling.

IMPORTANT: Be sure polarity is correct before making connections. Reversed polarity will damage electrical system. Always connect positive to positive and negative to ground. Always use 12-volt booster battery for 12-volt electrical systems and 24-volt booster battery (ies) for 24-volt electrical systems.

1. Connect booster battery or batteries to produce the required system voltage for your engine application.

NOTE: To avoid sparks, DO NOT allow the free ends of jumper cables to touch the engine.

2. Connect one end of jumper cable to the **POSITIVE (+)** post of the booster battery.
3. Connect the other end of the jumper cable to the **POSITIVE (+)** post of battery connected to starter.
4. Connect one end of the other jumper cable to the **NEGATIVE (-)** post of the booster battery.
5. ALWAYS complete the hookup by making the last connection of the **NEGATIVE (-)** cable to a good ground on the engine frame and away from the battery (ies).



Exploding Battery

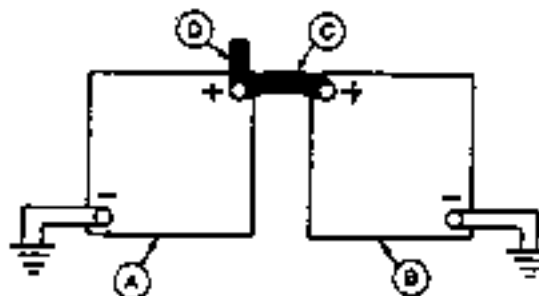

12-Volt System

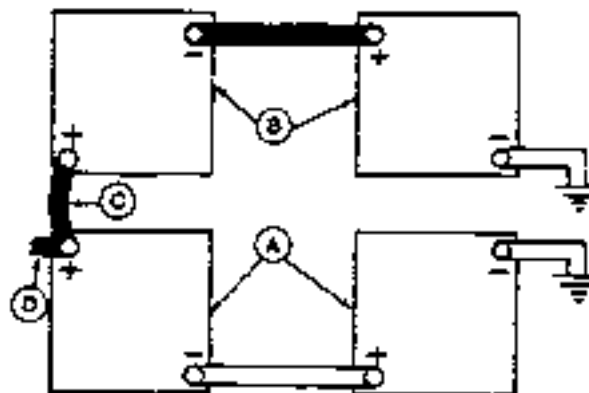

24-Volt System

A—12-Volt Machine Battery (ies)
 B—12-Volt Booster Battery (ies)
 C—Booster Cable
 D—Cable to Starting Motor

TSS204 -JUN-23AUG88

RG4678 -JUN-14DEC88

RG4698 -JUN-14DEC88

Continued on next page

RG, RG34710, 5564 -19-20MAY96-1/2

6. Start the engine. Disconnect jumper cables immediately after engine starts. Disconnect NEGATIVE (-) cable first.

RG, RG34710, 5564 -19-20MAY96-2/2

Avoid Excessive Engine Idling

Prolonged idling may cause the engine coolant temperature to fall below its normal range. This, in turn, causes crankcase oil dilution, due to incomplete fuel combustion, and permits formation of gummy deposits on valves, pistons, and piston rings. It also promotes rapid accumulation of engine sludge and unburned fuel in the exhaust system.

Once an engine is warmed to normal operating temperatures, engine should be idled at slow idle

speed. Slow idle speed for this engine is 850 rpm at factory. If an engine will be idling for more than 5 minutes, stop and restart later.

NOTE: Generator set applications where the governor is locked at a specified speed may not have a slow idle function. These engines will idle at no load governed speed (high idle).

RG, RG34710, 5562 -19-20MAY96-1/1

Changing Engine Speed

NOTE: On engines with **2-position** throttles, speeds are not adjustable. These throttles allows operation only at the preset rated speed or at idle using the single switch (A).

Changing from slow to fast speed using Standard High-Low Speed Select Rocker Switch (A) (If Equipped):

- For slow speed, press lower half of switch (indicated by turtle symbol).
- For fast speed, press upper half of switch (indicated by rabbit symbol).

NOTE: To adjust preset fast or slow speeds for High-Low Speed Select Rocker Switch:

1. Select fast (rabbit) or slow (turtle) position on High-Low Speed Select Rocker Switch (A).
2. Press and hold top or bottom half of Bump Speed Enable Rocker Switch (B) while using Speed Select Rocker Switch (C).
3. Use Speed Select Rocker Switch (C) to bump engine speed up (+) or down (-).

NOTE: Once the speed has been set, the Bump Speed Enable Switch (B) must be pressed and released three times within two seconds to commit the new slow or fast speed to memory. If not done, the engine's new slow or fast speed will only be effective until the key switch is shut off. Then the speed will revert to its previous setting.

Changing from slow to fast speed using Adjustable High-Low Speed Select Rocker Switch (A) (If Equipped):

Later engines have an adjustable **three-position** rocker switch (A) that can be used to select slow idle, fast idle, or an adjustable ("ADJ") intermediate speed.

- For slow speed, press lower half of rocker switch (indicated by turtle symbol).
- For fast speed, press upper half of rocker switch (indicated by rabbit symbol).

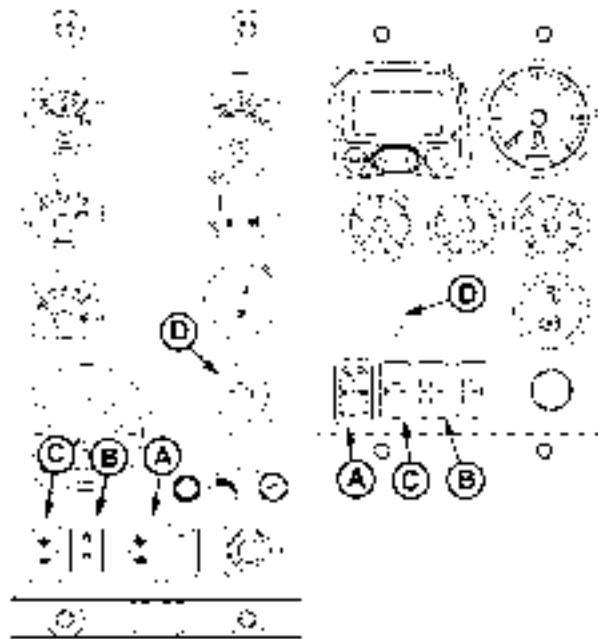

Changing Engine Speed On Earlier Panel (Left) or Later Panel (Right)

- A—High-Low Speed Select Rocker Switch
- B—Bump Speed Enable Rocker Switch
- C—Speed Select Rocker Switch
- D—Analog Throttle Control (Optional)

RG13282 -JUN-30OCT03

NOTE: To adjust preset fast or slow speeds with adjustable High-Low Speed Select Rocker Switch:

1. Select middle position (ADJ) or slow (turtle) position on the optional Adjustable Three-State Speed Select Rocker Switch (A).
2. Press and hold top or bottom half of Bump Speed Enable Rocker Switch (B) while using Speed Select Rocker Switch (C).
3. Use Speed Select Rocker Switch (C) to bump engine speed up (+) or down (-).

NOTE: Slow (turtle) position is factory preset at low engine idle, while middle (ADJ) position is factory set at high engine idle.

NOTE: Once the speed has been set, the Bump Speed Enable Switch (B) must be pressed and released three times within two seconds to commit the new slow or fast speed to memory. If not done, the engine's new slow or fast speed will only be effective until the key is shut off. Then the speed will revert to its previous setting.

Changing engine speed using optional analog potentiometer throttle (D)

NOTE: Pushing in on analog potentiometer will immediately take engine to slow idle speed.

1. Set High-Low Speed Select Rocker Switch (A) to low speed position.
2. Turn potentiometer throttle clockwise to increase speed or counterclockwise to decrease speed.

NOTE: Engine Control Unit (ECU) reads the higher of the High-Low Speed Select Rocker Switch or the Analog Throttle(s) Speed Settings. With High-Low switch at low speed, Analog Throttle(s) will control speed higher than low idle setting.

Continued on next page

OURGP11,000023F -19-21OCT03-2/3

Changing engine speeds on later engines equipped with the Basic Instrument Panel

The basic instrument panel has a "ramp" throttle switch (E) with a spring loaded return to the center rest position (Off).

To increase the engine speed, press and hold upper half of rocker switch (E) (indicated by rabbit symbol) to increase or ramp up the engine speed to desired speed. Release the rocker switch.

Press lower half of rocker switch (indicated by turtle symbol) to decrease or ramp down the engine speed to desired speed. Release the rocker switch.

The settings will not be stored.

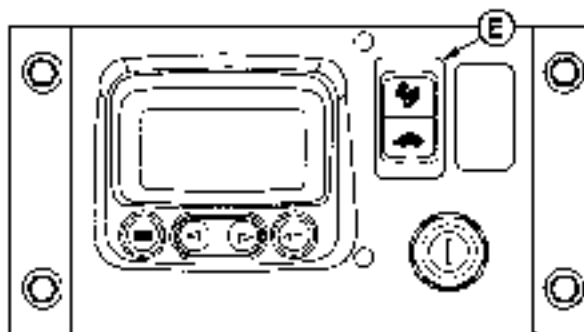

RG13289 -UN-30OCT03

Changing Engine Speed With Basic Panel

E—High-Low Speed Select Rocker Switch

OURGP11,000023F -19-21OCT03-3/3

Stopping The Engine

1. Disengage clutch, if equipped, controlling engine power driveline.

IMPORTANT: Before stopping an engine that has been operating at working load, idle engine at least 2 minutes at 1000—1200 rpm to cool hot engine parts.

Engines in generator set applications where the ECU is locked at a specified speed and no slow idle function is available, run engine for at least 2 minutes at fast idle and no load.

2. Run engine at 1000—1200 rpm for at least 2 minutes to cool.

Panels with High-Low Speed Select Rocker Switch (B) only: Set rpm using Bump Speed Enable Switch (C) with Speed Select Rocker Switch (D).

Panels with optional Analog Throttle (E): Set either High-Low Speed Select Switch (B) or Analog Throttle (E) to low idle, and set desired speed with remaining control.

NOTE: Engine Control Unit (ECU) reads the higher of the High-Low Speed Select Rocker Switch or the Analog Throttle(s) Speed settings.

3. Push in on analog throttle potentiometer handle (if equipped) so that engine goes to slow idle, or set slow speed with High-Low Speed Select Rocker Switch.

4. Turn key switch (A) to "OFF" position to stop the engine. Remove ignition key.

IMPORTANT: Make sure that exhaust stack rain cap (F) is installed when engine is not running. This will prevent water and dirt from entering engine.

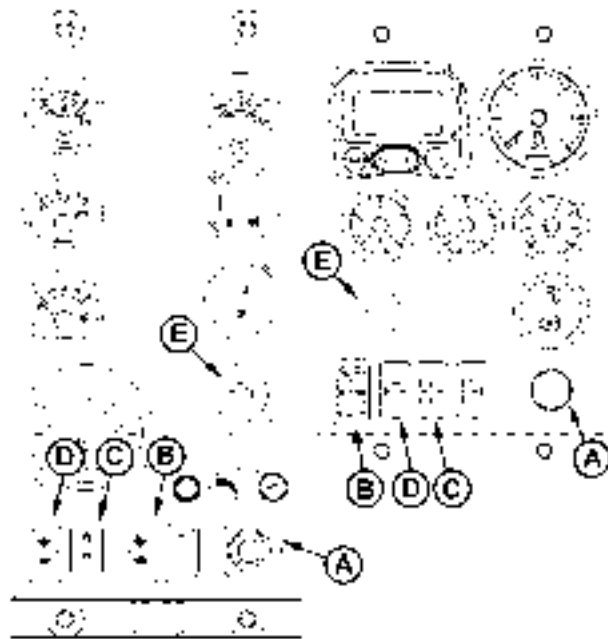

Stopping the Engine On Earlier Panel (Left) or Later Panel (Right)

RG13280 -UN-30OCT03



Exhaust Stack Rain Cap

RG9933 -UN-18NOV99

- A—Key Switch
- B—High-Low Speed Select Rocker Switch
- C—Bump Speed Enable Switch
- D—Speed Select Rocker Switch
- E—Analog Throttle (Optional)
- F—Exhaust Stack Rain Cap

Auxiliary Gear Drive Limitations

IMPORTANT: When attaching an air compressor, hydraulic pump, or other accessory to be driven by the auxiliary gear drive (A) (engine timing gear train at front of engine), power requirements of the accessory must be limited to values listed below:

- 30 kW (40 hp) Continuous Operation at 2500 rpm
- 37 kW (50 hp) Intermittent Operation at 2500 rpm

A—Auxiliary Gear Drive

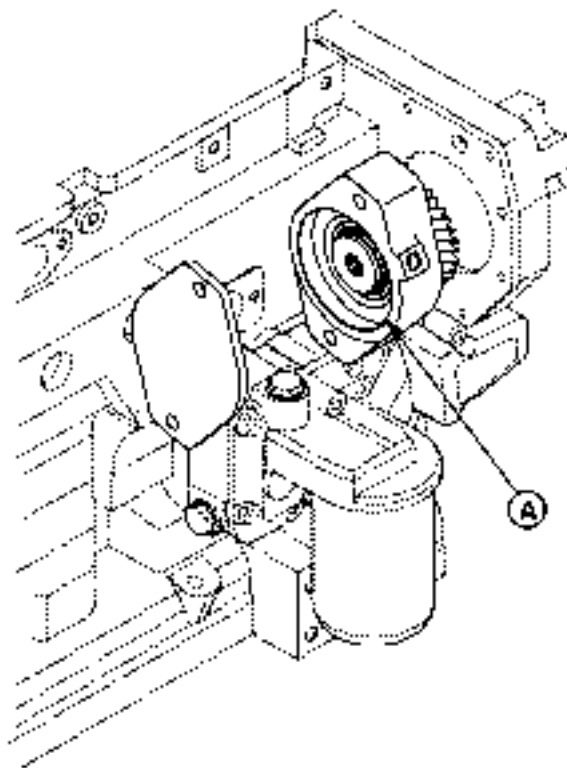

RG7634A -JUN-22JAN99

Auxiliary Gear Drive

RG, RG34710, 5555 -19-20MAY96-1/1

Generator Set (Standby) Applications

To assure that your engine will deliver efficient standby operation when needed, start engine and run at rated speed (with 50%—70% load) for 30 minutes every 2 weeks. DO NOT allow engine to run extended period of time with no load.

RG, RG34710, 5556 -19-20MAY96-1/1

Engine Operation- 4.5 L “270” Engines

Normal Engine Operation

Before starting, fill engine with oil and coolant meeting specifications. (See DIESEL ENGINE BREAK-IN OIL and DIESEL ENGINE COOLANT SPECIFICATIONS in Fuels, Lubricants, and Coolant section.)

- Observe engine coolant temperature and engine oil pressure. Temperatures and pressures will vary between engines and with changing operating conditions, temperatures, and loads.
- Normal engine coolant operating temperature range is 90° – 100° C (194° – 212° F). If coolant temperature rises above 105° C (221° F), reduce load on engine. Unless temperature drops quickly, stop engine and determine cause before resuming operation.
- Operate the engine under a lighter load and at slower than normal speed for first 15 minutes after start-up. DO NOT run engine at slow idle.
- Stop engine immediately if there are any signs of part failure. Symptoms that may be early signs of engine problems are:
 - Sudden drop in oil pressure
 - Abnormal coolant temperatures
 - Unusual noise or vibration
 - Sudden loss of power
 - Excessive black exhaust
 - Excessive fuel consumption
 - Excessive oil consumption
 - Fluid leaks

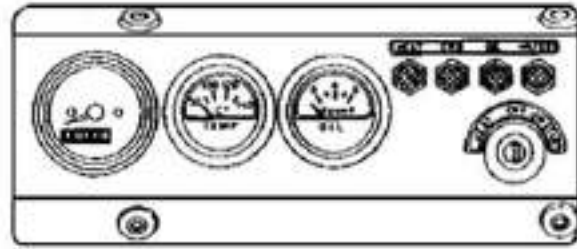

Instrument Panel (Earlier 4.5 L “270” Engines)

RG13343 -UN-24NOV03

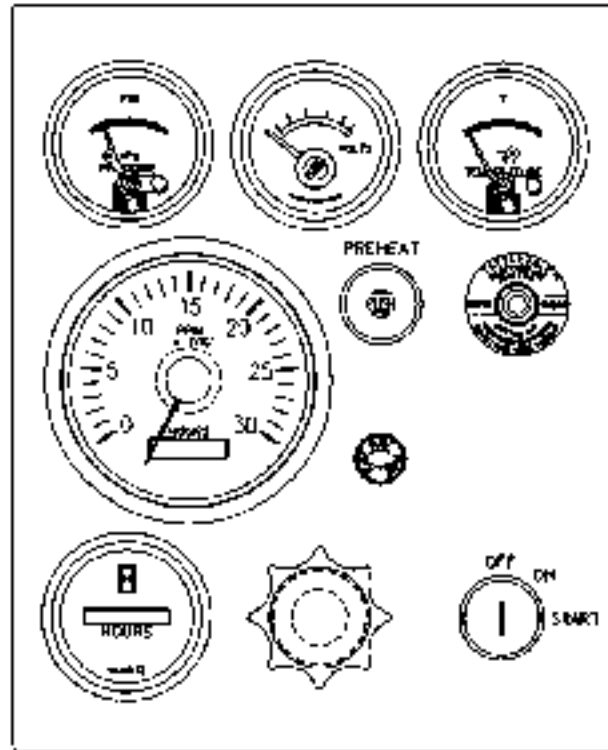

Instrument Panel (Later 4.5 L “270” Engines)

RG13359 -UN-06FEB04

OURGP11,000027D -19-25NOV03-1/1

Break-In Service

Before starting, fill engine with seasonal viscosity grade oil and with coolant meeting specifications. (See DIESEL ENGINE OIL and DIESEL ENGINE COOLANT SPECIFICATIONS in Fuels, Lubricants, and Coolant Section.)



RG12692 -UN-07FEB03

Check Engine Oil Level Daily

1. During the first 20 hours, avoid prolonged periods of engine idling or sustained maximum load operation. Warm-up engine carefully and operate at normal loads. If engine will idle longer than 5 minutes, stop engine.
2. Check oil level daily or every 10 hours during engine break-in period. If oil must be added during this period, use seasonal viscosity grade oil. (See DIESEL ENGINE OIL in Fuels, Lubricants, and Coolant section.)

OURGP11,0000169 -19-06FEB04-1/3

3. Watch oil pressure (A) and coolant temperature (B) closely during break-in period. Also check coolant level daily or every 10 hours and check for leaks.
4. Check poly-vee belt for proper alignment and seating in pulley grooves.

A—Oil Pressure Gauge
B—Coolant Temperature Gauge

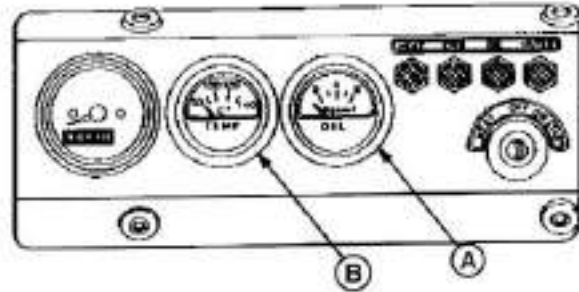

Oil Pressure and Coolant Temperature Gauges (Earlier Engines)

RG6574 -UN-17FEB03

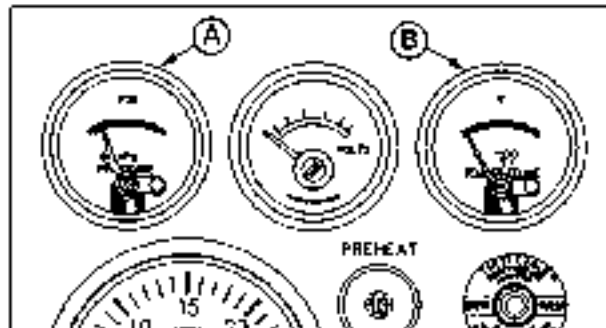

Oil Pressure and Coolant Temperature Gauges (Later Engines)

RG13361 -UN-06FEB04

Continued on next page

OURGP11,0000169 -19-06FEB04-2/3

5. Change engine oil and oil filter after the first 100 hours of use. After break-in period, change oil and filter every 500 hours/12 months. (See CHANGE ENGINE OIL AND FILTER in Lubrication and Maintenance/500 Hour Section.) Fill crankcase with seasonal viscosity grade oil. (See DIESEL ENGINE OIL, in Fuels, Lubricants, and Coolant Section.)

IMPORTANT: DO NOT operate engine when oil level is below ADD mark on dipstick. Check oil level before starting engine for the first time.



Engine Oil Filter

RG11616 -UN-24OCT01

OURGP11,0000169 -19-06FEB04-3/3

Auxiliary Gear Drive Limitations

IMPORTANT: When attaching an air compressor, hydraulic pump, or other accessory to be driven by the auxiliary gear drive (A) (engine timing gear train at front of engine), power requirements of the accessory must be limited to values listed below:

- 30 kW (40 hp) Continuous Operation at 2500 rpm
- 37 kW (50 hp) Intermittent Operation at 2500 rpm

A—Auxiliary Gear Drive

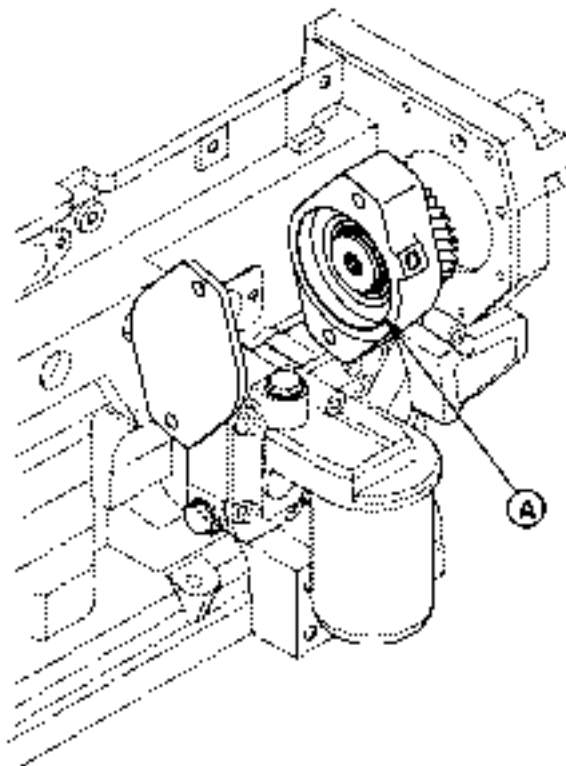

Auxiliary Gear Drive

RG7634A -UN-22JAN99

RG, RG34710, 5555 -19-20MAY96-1/1

Generator Set (Standby) Power Units

To assure that your engine will deliver efficient standby operation when needed, start engine and run at rated speed (with 50%—70% load) for 30 minutes every 2 weeks. DO NOT allow engine to run extended period of time with no load.

RG41183,00002F -19-16DEC02-1/1

Starting The Engine

The controls and instruments for your engine may be different from those shown here. Always follow manufacturer's instructions and familiarize yourself with the correct starting procedure.

 **CAUTION: Before starting engine in a confined building, install proper outlet exhaust ventilation equipment. Always use safety approved fuel storage and piping.**

NOTE: If temperature is below 0° C (32° F), it may be necessary to use cold weather starting aids. (See COLD WEATHER OPERATION, later in this section).

1. Perform all prestarting checks outlined in Lubrication & Maintenance/Daily Section later in this manual.
2. Disengage engine rear driveline (if equipped) or gen set drive.
3. Open the fuel supply shut-off valve, if equipped.
4. Place the speed control lever in the "START" position, if equipped.



Use Proper Ventilation

TS220 -JUN-23AUG88

Continued on next page

OURGP11,000016A -19-06FEB04-1/2

IMPORTANT: Do not operate the starter for more than 15 seconds at a time. To do so may overheat the starter. If the engine does not start the first time, wait at least 2 minutes before trying again. If engine does not start after four attempts, see Troubleshooting Section.

5. **Earlier Engines:** Turn key switch to "START" position as shown and hold until engine starts. Release key once engine starts; key automatically returns to "ON" position and instrument panel gauges start operating.



RG6580 -UN-20JAN93

Starting Engine Using Key Switch (Earlier Engines)

Later Engines: Press and hold in the reset button (A) while turning key switch (B) to "START" position and hold until engine starts. Release key once engine starts; key automatically returns to "ON" position and instrument panel gauges start operating. Continue to hold in the reset button until the oil pressure is at a safe operating level.

6. Warm-up engine for at least 5 minutes before applying a load. (See WARMING-UP ENGINE, later in this section.)

7. Check all gauges for normal operation. If operation is not normal, stop engine immediately and determine cause.

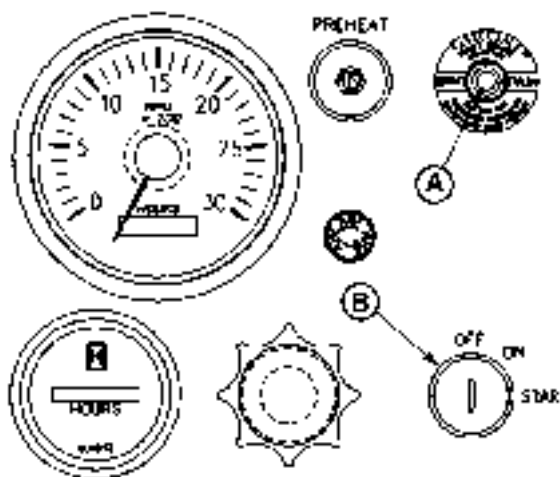

RG13366 -UN-12FEB04

Starting Engine Using Reset Button and Key Switch (Later Engines)

A—Reset Button
B—Key Switch

OURGP11,000016A -19-06FEB04-2/2

Cold Weather Starting

When outside temperatures fall below 0°C (32° F) it may be necessary to consider using cold weather starting aids.

Your PowerTech™ Engines may be fitted with a block heater, glow plugs, air intake heater and increased capacity battery and/or lower viscosity oil may also be used. See your local John Deere engine distributor or servicing dealer for recommendations.

1. Perform all prestarting checks outlined in Lubrication & Maintenance/Daily Section later in this manual.
2. Disengage engine rear driveline (if equipped) or gen set drive.
3. Open the fuel supply shut-off valve, if equipped.
4. Place the speed control lever in the "START" position, if equipped.

IMPORTANT: Do not operate the starter for more than 15 seconds at a time. To do so may overheat the starter. If the engine does not start the first time, wait at least 2 minutes before trying again. If engine does not start after four attempts, see Troubleshooting Section.

5. **Earlier Engines (Shown)** - Turn key switch to "HEAT" position and hold until heat indicator lamp on instrument panel goes out. Turn key switch to "START" and hold until engine starts. Release key switch once engine starts; key automatically returns to "ON" position and instrument panel gauges start operating.



RG6580 -UN-20JAN93

Starting Engine

Later Engines - Turn key switch to "ON" position and hold "PREHEAT" button (if equipped with preheat option) in for up to 30 seconds. Turn key switch to "START" while continuing to hold the "PREHEAT" button and the reset button. Hold until engine starts. Release key and "PREHEAT" button once engine starts; key automatically returns to "ON" position and instrument panel gauges start operating. Release reset button when oil pressure is at a safe operating level.

6. Warm-up engine for at least 5 minutes before applying a load. (See WARMING ENGINE, later in this section.)

OURGP11,000018A -19-10FEB04-2/2

Warming Engine

IMPORTANT: To assure proper lubrication, operate engine at or below 1200 rpm with no load for 1–2 minutes. Extend this period 2–4 minutes when operating at temperatures below freezing.

Engines used in generator set applications where the governor is locked at a specified speed may not have a slow idle function. Operate these engines at high idle for 1 to 2 minutes before applying the load. This procedure does not apply to standby generator sets where the engine is loaded immediately upon reaching rated speed.

1. Check oil pressure gauge (A) as soon as engine starts. If gauge needle does not rise above minimum oil pressure specification of 105 kPa (1.05 bar) (15.0 psi) within 5 seconds, stop the engine and determine the cause. Normal engine oil pressure is 345 ± 103 kPa (3.45 ± 1.03 bar) (50 ± 15 psi) at rated full load speed (1800–2500 rpm) with oil at normal operating temperature of 115° C (240° F). This oil pressure can vary from 35 psi to 65 psi.

NOTE: On certain engines, the oil pressure and coolant temperature gauges are replaced by indicator warning lights. The lights must be "OFF" when engine is running.

2. Watch coolant temperature gauge (B). Do not place engine under full load until it is properly warmed up. The normal engine coolant temperature range is 90°–100° C (194°–212° F).

NOTE: It is a good practice to operate the engine under a lighter load and at lower speeds than normal for the first few minutes after start-up.

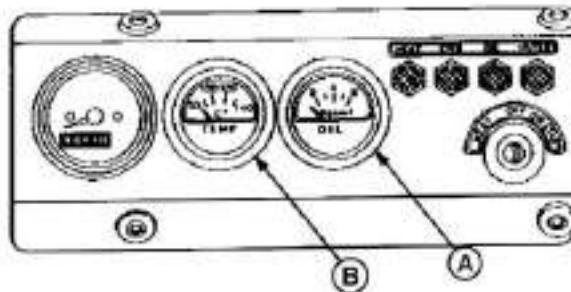

Oil Pressure and Coolant Temperature Gauges (Earlier Engines)

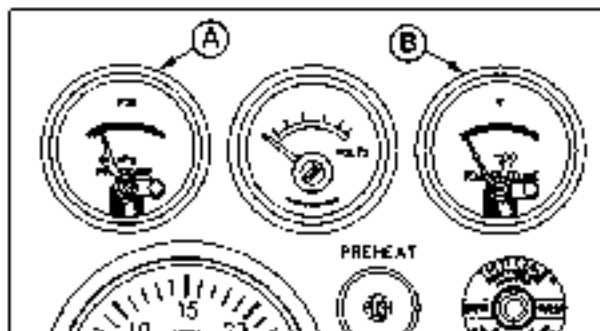

Oil Pressure and Coolant Temperature Gauges (Later Engines)

A—Oil Pressure Gauge
B—Coolant Temperature Gauge

RG6674 -UN-17FEB03

RG13361 -UN-06FEB04

Avoid Excessive Engine Idling

Avoid excessive engine idling. Prolonged idling may cause the engine coolant temperature to fall below its normal range. This, in turn, causes crankcase oil dilution, due to incomplete fuel combustion, and permits formation of gummy deposits on valves, pistons, and piston rings. It also promotes rapid accumulation of engine sludge and unburned fuel in the exhaust system.

Once an engine is warmed to normal operating temperatures, engine should be idled at slow idle speed. Slow idle speed for this engine is 900 rpm at factory. If an engine will be idling for more than 5 minutes, stop and restart later.

NOTE: Generator set applications where the governor is locked at a specified speed may not have a slow idle function. These engines will idle at no load governed speed (high idle).

RG41183,0000034 -19-16DEC02-1/1

Stopping the Engine

IMPORTANT: Stopping the engine immediately when it has been working under load, can result in overheating and accelerated wear of the engine components. **ALWAYS** run the engine at slow idle and no load to allow hot engine parts to cool before shutdown (if possible).

On engines with variable speed governors, remove load from engine and run engine for at least 2 minutes. Run turbocharged engines for 3 to 5 minutes.

On generator set engines with governors locked at a specific speed, remove electrical load from engine (if possible) and run at fast idle and no load for at least 2 minutes.

1. Reduce engine speed to slow idle (variable speed governors only).
2. Turn key switch (A) to "OFF" position to stop the engine. After engine stops, close valve on fuel supply to prevent accidental starting.

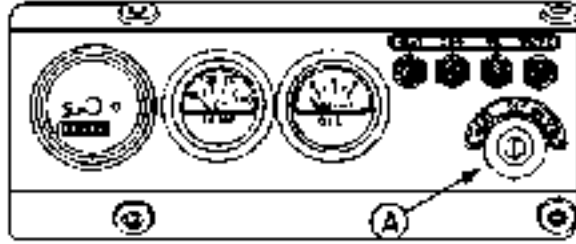

Key Switch on Instrument Panel (Earlier Engines)

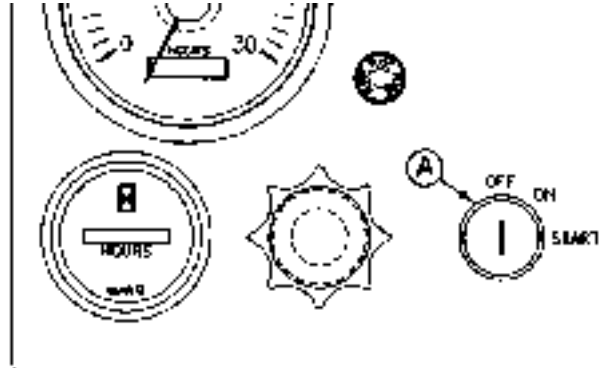

Key Switch on Instrument Panel (Later Engines)

OURGP11.0000134 -19-20NOV03-1/2

IMPORTANT: Make sure that exhaust stack cap (rain cap) is in place when engine is not running. This will prevent water and dirt from entering engine.

3. Fill fuel tank to minimize possible water condensation problems. Filling tanks at end of day drives out moisture-laden air.



Exhaust Stack Rain Cap

OURGP11.0000134 -19-20NOV03-2/2

Using a Booster Battery or Charger

A 12-volt booster battery can be connected in parallel with battery (ies) on the unit to aid in cold weather starting. ALWAYS use heavy duty jumper cables.

CAUTION: Gas given off by battery is explosive. Keep sparks and flames away from battery. Before connecting or disconnecting a battery charger, turn charger off. Make last connection and first disconnection at a point away from battery. Always connect **NEGATIVE (-)** cable last and disconnect this cable first.

WARNING: Battery posts, terminals, and related accessories contain lead and lead compounds, chemicals known to the State of California to cause cancer and reproductive harm. Wash hands after handling.

IMPORTANT: Be sure polarity is correct before making connections. Reversed polarity will damage electrical system. Always connect positive to positive and negative to ground. Always use 12-volt booster battery for 12-volt electrical systems and 24-volt booster battery (ies) for 24-volt electrical systems.

1. Connect booster battery or batteries to produce the required system voltage for your engine application.

NOTE: To avoid sparks, DO NOT allow the free ends of jumper cables to touch the engine.

2. Connect one end of jumper cable to the **POSITIVE (+)** post of the booster battery.
3. Connect the other end of the jumper cable to the **POSITIVE (+)** post of battery connected to starter.
4. Connect one end of the other jumper cable to the **NEGATIVE (-)** post of the booster battery.
5. ALWAYS complete the hookup by making the last connection of the **NEGATIVE (-)** cable to a good ground on the engine frame and away from the battery (ies).



Exploding Battery

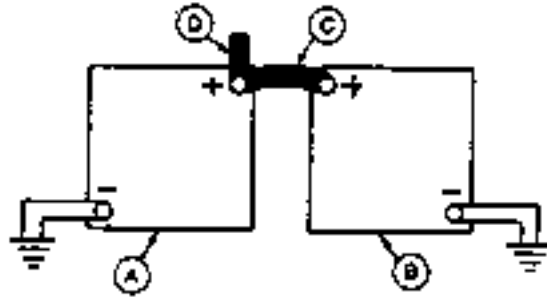

12-Volt System

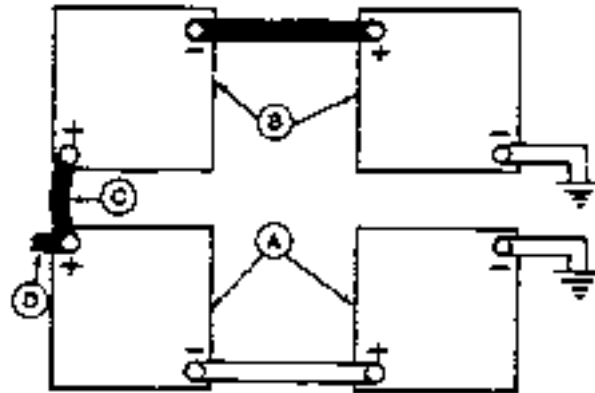

24-Volt System

A—12-Volt Machine Battery (ies)
 B—12-Volt Booster Battery (ies)
 C—Booster Cable
 D—Cable to Starting Motor

TSS04 -JUN-23AUG88

RG4678 -JUN-14DEC88

RG4698 -JUN-14DEC88

Continued on next page

RG, RG34710, 5564 -19-20MAY96-1/2

6. Start the engine. Disconnect jumper cables immediately after engine starts. Disconnect NEGATIVE (-) cable first.

RG, RG34710, 5564 -19-20MAY96-2/2

Lubrication and Maintenance

Observe Service Intervals

Using hour meter (A) on diagnostic gauge as a guide, perform all services at the hourly intervals indicated on following pages. At each scheduled maintenance interval, perform all previous maintenance operations in addition to the ones specified. Keep a record of hourly intervals and services performed, using charts provided in Lubrication and Maintenance Records section.

IMPORTANT: Recommended service intervals are for normal operating conditions. Service **MORE OFTEN** if engine is operated under adverse conditions. Neglecting maintenance can result in failures or permanent damage to the engine.

A—Hour Meter

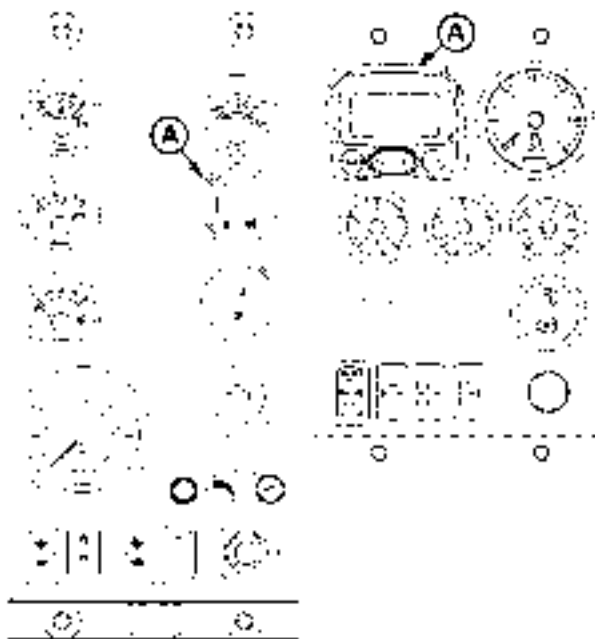

Hour Meter On Earlier Panel (Left) or Later Panel (Right) (Except 4.5 L "270" Engines)

RG13283 -JUN-30OCT03

OURGP11,0000241 -19-21OCT03-1/1

Use Correct Fuels, Lubricants, and Coolant

IMPORTANT: Use only fuels, lubricants, and coolants meeting specifications outlined in Fuels, Lubricants, and Coolant Section when servicing your John Deere Engine.

Consult your John Deere engine distributor, servicing dealer or your nearest John Deere Parts Network for recommended fuels, lubricants, and coolant. Also available are necessary additives for use when operating engines in tropical, arctic, or any other adverse conditions.



John Deere Parts Network

TS100 -JUN-23AUG88

DPSG,OUOE003,20 -19-06JAN99-1/1

Lubrication and Maintenance Service Interval Chart—Standard Industrial Engines

NOTE: The service intervals below are for standard industrial engines. See details in Sections which follow these charts.

Item	Lubrication and Maintenance Service Intervals			
	Daily	500 Hour/ 12 Month	2000 Hour/ 24 Month	As Required
Check Engine Oil and Coolant Level	•			
Check Fuel Filter/Water Bowl	•			
Check Air Cleaner Dust Unloader Valve & Restriction Indicator Gauge ^a	•			
Visual Walk Around Inspection	•			
Check Lamps (4045DF/TF270)	•			
Service Fire Extinguisher		•		
Check Engine Mounts		•		
Service Battery		•		
Check Manual Belt Tensioner and Belt Wear		•		
Change Engine Oil And Replace Oil Filter ^{b, c}		•		
Check Crankcase Vent System		•		
Check Air Intake Hoses, Connections, & System		•		
Replace Fuel Filter Elements and Bleed System		•		
Check Automatic Belt Tensioner and Belt Wear		•		
Check Engine Electrical Ground Connection		•		
Check Cooling System		•		
Coolant Solution Analysis-Add SCAs as required		•		
Pressure Test Cooling System		•		
Check Engine Speeds		•		
Check Crankshaft Vibration Damper (6.8 L Engines) ^d			•	
Flush and Refill Cooling System ^e			•	
Test Thermostats			•	
Check and Adjust Engine Valve Clearance			•	
Test Glow Plugs (4045HF475, 6068HF475)			•	

^aReplace primary air cleaner element when restriction indicator shows a vacuum of 625 mm (25 in.) H₂O.

^bDuring engine break-in, change the oil and filter for the first time before 100 hours of operation.

^cIf the recommended engine oils, John Deere PLUS-50™ or ACEA-E4/E5, are not used, the oil and filter change interval is reduced to every 250 hours. If diesel fuel with a sulfur content greater than 0.05% is used, the oil and filter change interval is also reduced. 6-Cylinder engines with oil pan option codes 1907, 1908, and 1909 require the oil to be changed at every 250 hours regardless of oil specification used.

^dReplace crankshaft damper every 4500 hours or 60 months, whichever occurs first.

^eIf John Deere COOL-GARD is used, the flushing interval may be extended to 3000 hours or 36 months. If John Deere COOL-GARD is used and the coolant is tested annually AND additives are replenished as needed by adding a supplemental coolant additive, the flushing interval may be extended to 5000 hours or 60 months, whichever occurs first.

Continued on next page

OURGP11.000021D -19-15OCT03-1/2

Lubrication and Maintenance

Item	Lubrication and Maintenance Service Intervals			
	Daily	500 Hour/ 12 Month	2000 Hour/ 24 Month	As Required
Add Coolant				•
Replace Air Cleaner Elements				•
Replace Fan and Alternator Belts				•
Check Fuses				•
Check Air Compressor (If Equipped)				•
Bleed Fuel System				•

OURGP11,000021D -19-15OCT03-2/2

Lubrication and Maintenance Service Interval Chart—Generator (Standby) Applications

NOTE: Use service intervals listed below for generator (standby) applications. Match service items below to titles in Lubrication and Maintenance Sections for procedures.

Item	Lubrication and Maintenance Service Intervals			
	Every 2 Weeks	500 Hours or 12 Months	2000 Hours or 24 Months	As Required
Operate Engine at Rated Speed and 50%–70% Load a Minimum of 30 Minutes	•			
Check Engine Oil and Coolant Level	•			
Check Fuel Filter/Water Bowl	•			
Check Air Cleaner Dust Unloader Valve & Restriction Indicator Gauge ^a	•			
Visual Walk Around Inspection	•			
Check Lamps (4045DF/TF270)	•			
Service Fire Extinguisher		•		
Check Engine Mounts		•		
Service Battery		•		
Check Manual Belt Tensioner and Belt Wear		•		
Change Engine Oil And Replace Oil Filter ^{b, c}		•		
Check Crankcase Vent System		•		
Check Air Intake Hoses, Connections, & System		•		
Replace Fuel Filter Elements—Bleed Fuel System		•		
Check Automatic Belt Tensioner and Belt Wear		•		
Check Engine Electrical Ground Connection		•		
Check Cooling System		•		
Coolant Solution Analysis-Add SCAs as required		•		
Pressure Test Cooling System		•		
Check Engine Speeds		•		
Adjust Variable Speed (Droop) (4.5 L "270" Engines)			•	
Check Crankshaft Vibration Damper (6.8 L Engines) ^d			•	
Flush and Refill Cooling System			•	
Test Thermostats			•	
Check and Adjust Engine Valve Clearance			•	
^a Replace primary air cleaner element when restriction indicator shows a vacuum of 625 mm (25 in.) H ₂ O.				
^b During engine break-in, change the oil and filter for the first time before 100 hours of operation.				
^c If the recommended engine oils, John Deere PLUS-50™ or ACEA-E4/E5, are not used, the oil and filter change interval is reduced to every 250 hours. If diesel fuel with a sulfur content greater than 0.05% is used, the oil and filter change interval is also reduced. 6-Cylinder engines with oil pan option codes 1907, 1908, and 1909 require the oil to be changed at every 250 hours regardless of oil specification used.				
^d Replace crankshaft damper every 4500 hours or 60 months, whichever occurs first.				

Continued on next page

OURGP11.000021E -19-15OCT03-1/2

Lubrication and Maintenance

Item	Lubrication and Maintenance Service Intervals			
	Every 2 Weeks	500 Hours or 12 Months	2000 Hours or 24 Months	As Required
Test Glow Plugs (4045HF475, 6068HF475)			•	
Add Coolant				•
Replace Air Cleaner Elements				•
Replace Fan and Alternator Belts				•
Check Fuses				•
Check Air Compressor (If Equipped)				•
Bleed Fuel System				•

OURGP11,000021E -19-15OCT03-2/2

Lubrication & Maintenance/Daily

Daily Prestarting Checks

Do the following BEFORE STARTING THE ENGINE for the first time each day:

IMPORTANT: DO NOT add makeup oil until the oil level is **BELOW** the crosshatch marks on the dipstick.

1. Check engine oil level on dipstick. Add as required, using seasonal viscosity grade oil. (See DIESEL ENGINE OIL in Fuels, Lubricants, and Coolant Section for oil specifications.)

Depending on application, oil may be added at left (A) or right (B) side oil filler cap and rocker arm cover filler cap (C) locations.

IMPORTANT: DO NOT fill above the top mark on the dipstick. Oil levels anywhere within crosshatch (D) are considered in the acceptable operating range.

- A—Left Side Oil Filler Cap
- B—Right Side Oil Filler Cap
- C—Cover Oil Filler Cap
- D—Crosshatch On Dipstick



Left Side Oil Filler Cap

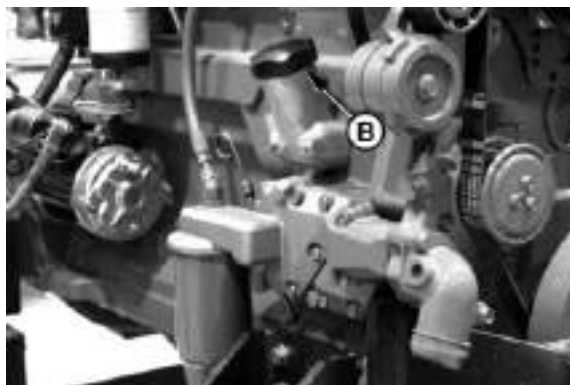

Right Side Oil Filler Cap



Rocker Arm Cover Filler Cap

RG8028B -UN-15JAN99

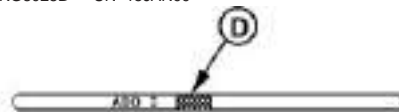

Crosshatch on Dipstick

Continued on next page

OURGP11.000018F -19-12FEB04-1/5

CAUTION: Explosive release of fluids from pressurized cooling system can cause serious burns.

Only remove filler cap when engine is cold or when cool enough to touch with bare hands. Slowly loosen cap to first stop to relieve pressure before removing completely.

2. Check the coolant level when engine is cold. Coolant level should be at bottom of filler neck. Fill radiator (A) with proper coolant solution if level is low. (See ADDING COOLANT in Service As Required Section.) Check overall cooling system for leaks.

NOTE: Refer to your vehicle's operator's manual for recommendations for non-John Deere supplied accessories.

A—Fill Radiator



High-Pressure Fluids

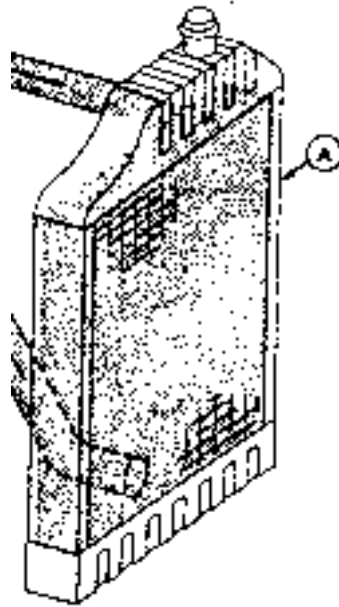

Fill Radiator

RG4675 -UN-14DEC88

TSS281 -UN-23AUG88

Continued on next page

OURGP11_000018F -19-12FEB04-2/5

NOTE: Engine may be equipped with a water sensor at the fuel filter. In this case, an indicator light will signal the operator that water should be drained from the filter bowl.

3. Check the fuel filters for water or debris. If filter is fitted with a see-through bowl, drain as needed based on a daily visual inspection.

IMPORTANT: Drain water into a suitable container and dispose of properly.

- a. Loosen drain plugs (A) at bottom of fuel filters or bowls, if equipped, two or three turns.
- b. Loosen air bleed plug (B) two full turns on fuel filter mounting and drain water from bottom until fuel starts to drain out.
- c. When fuel starts to drain out, tighten drain plugs securely.

After draining water from the fuel filters, the filters must be primed by bleeding all air from the fuel system. See **BLEEDING FUEL SYSTEM** in Service As Required Section, later in this manual



RG112222 -UN-24MAY02

Drain Final Fuel Filter

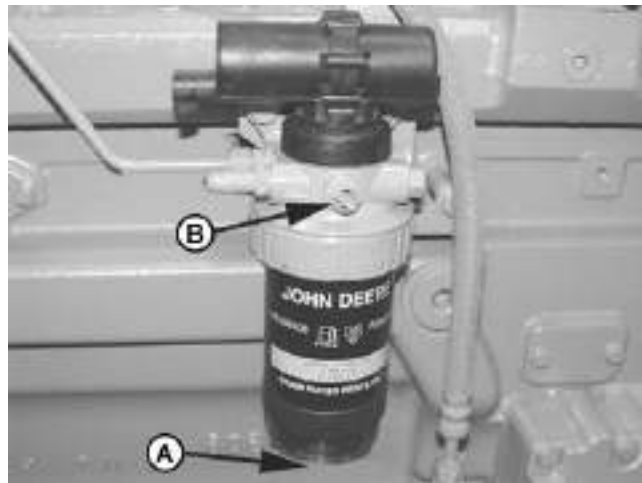

RG119555 -UN-05DEC01

Drain Primary Fuel Filter (If Equipped)

A—Drain Plug
B—Air Bleed Plug

Continued on next page

OURGP11,000018F -19-12FEB04-3/5

4. If the air cleaner has an automatic dust unloader valve (A), squeeze the unloader valve on air cleaner assembly to clear away any dust buildup.

If equipped with air intake restriction indicator gauge (B), check gauge to determine if air cleaner needs to be serviced.

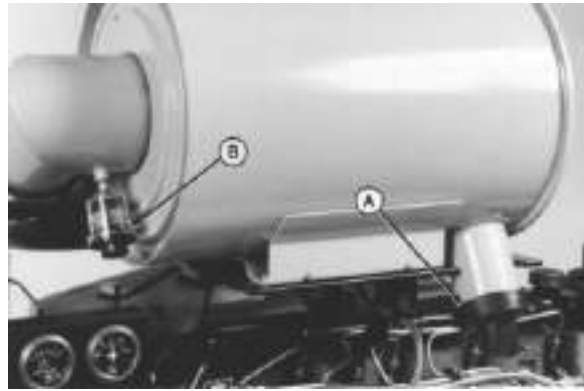

RG7332A -UN-22JAN99

Dust Unloader Valve and Indicator Gauge

A—Dust Unloader Valve
B—Air Restriction Indicator

IMPORTANT: Maximum air intake restriction is 6.25 kPa (0.06 bar) (1.0 psi) (25 in. H₂O). A clogged air cleaner element will cause excessive intake restriction and a reduced air supply to the engine.

5. Make a thorough inspection of the engine compartment. Look for oil or coolant leaks, worn fan and accessory drive belts, loose connections and trash build-up. Remove trash buildup and have repairs made as needed if leaks are found.

NOTE: Wipe all fittings, caps, and plugs before performing any maintenance to reduce the chance of system contamination.

Inspect:

- Radiator for leaks and trash build-up.
- Air intake system hoses and connections for cracks and loose clamps.
- Fan, alternator, and accessory drive belts for cracks, breaks or other damage.
- Coolant pump for coolant leaks.

NOTE: It is normal for a small amount of leakage to occur as the engine cools down and parts contract. Excessive coolant leakage may indicate the need to replace the coolant pump seal. Contact your engine distributor or servicing dealer for repairs.

Continued on next page

OURGP11,000018F -19-12FEB04-4/5

6. **4.5 L Suffix "270" Earlier Engines Only:** Turn key switch to "ON" position and check lamps. "WATER" lamp should be off, while "OIL" and "CHG" lamps should be lit.

Replace lamps as needed. If this does not solve any problems, see your John Deere dealer or distributor.



Key Switch in "ON" Position (4.5 L "270" Engines)

OURGP11,000018F -19-12FEB04-5/5

Lubrication & Maintenance/500 Hour/12 Month

Servicing Fire Extinguisher

A fire extinguisher (A) is available from your authorized servicing dealer or engine distributor.

Read and follow the instructions which are packaged with it. The extinguisher should be inspected at least every 500 hours of engine operation or every 6 months. Once extinguisher is operated, no matter how long, it must be recharged. Keep record of inspections on the tag which comes with the extinguisher instruction booklet.

A—Fire Extinguisher



Fire Extinguisher

RW4918 -UN-15DEC88

OURGP11,000015F -19-28JAN04-1/1

Checking Engine Mounts

Engine mounting is the responsibility of the vehicle or generator manufacturer. Follow manufacturer's guidelines for mounting specifications.

IMPORTANT: Use only Grade SAE 8 or higher grade of hardware for engine mounting.

1. Check the engine mounting brackets (A), vibration isolators, and mounting bolts on support frame and engine block for tightness. Tighten as necessary.
2. Inspect overall condition of vibration isolators, if equipped. Replace isolators, as necessary, if rubber has deteriorated or mounts have collapsed.

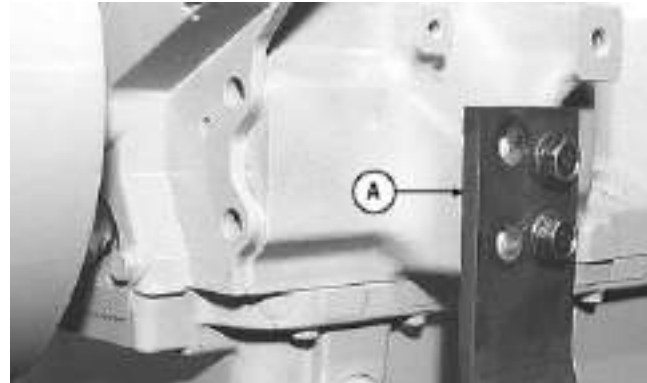

Engine Mounting

A—Mounting Bracket

RG9905 -UN-06JAN99

OURGP11,0000110 -19-16OCT03-1/1

Servicing Battery



CAUTION: Battery gas can explode. Keep sparks and flames away from batteries. Use a flashlight to check battery electrolyte level.

Never check battery charge by placing a metal object across the posts. Use a voltmeter or hydrometer.

Always remove grounded **NEGATIVE (-)** battery clamp first and replace it last.



Exploding Battery

TSS204 -JUN-23AUG88

WARNING: Battery posts, terminals, and related accessories contain lead and lead compounds, chemicals known to the State of California to cause cancer and reproductive harm. **Wash hands after handling.**

1. On regular batteries, check electrolyte level. Fill each cell to bottom of filler neck with distilled water.

NOTE: Low-maintenance or maintenance-free batteries should require little additional service. However, electrolyte level can be checked by cutting the center section of decal on dash-line, and removing cell plugs. If necessary, add clean, soft water to bring level to bottom of filler neck.

2. Keep batteries clean by wiping them with a damp cloth. Keep all connections clean and tight. Remove any corrosion, and wash terminals with a solution of 1 part baking soda and 4 parts water. Tighten all connections securely.

NOTE: Coat battery terminals and connectors with a mixture of petroleum jelly and baking soda to retard corrosion.

3. Keep battery fully charged, especially during cold weather. If a battery charger is used, turn charger off before connecting charger to battery(ies). Attach **POSITIVE (+)** battery charger lead to **POSITIVE (+)** battery post. Then attach **NEGATIVE (-)** battery charger lead to a good ground.

Continued on next page

RG, RG34710, 5568 -19-20MAY96-1/2

CAUTION: Sulfuric acid in battery electrolyte is poisonous. It is strong enough to burn skin, eat holes in clothing, and cause blindness if splashed into eyes.

Avoid the hazard by:

1. Filling batteries in a well-ventilated area.
2. Wearing eye protection and rubber gloves.
3. Avoiding breathing fumes when electrolyte is added.
4. Avoiding spilling or dripping electrolyte.
5. Use proper jump start procedure.

If you spill acid on yourself:

1. Flush your skin with water.
2. Apply baking soda or lime to help neutralize the acid.
3. Flush your eyes with water for 10–15 minutes. Get medical attention immediately.

If acid is swallowed:

1. Drink large amounts of water or milk.
2. Then drink milk of magnesia, beaten eggs, or vegetable oil.
3. Get medical attention immediately.

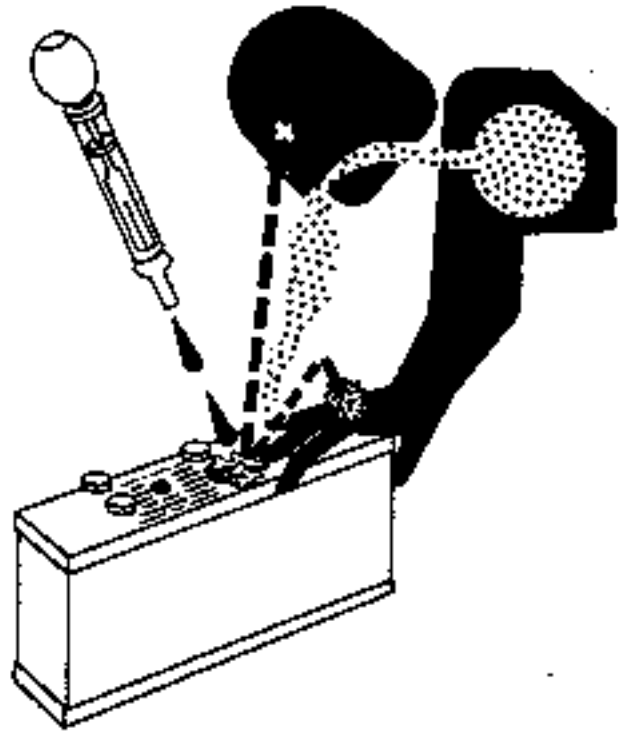

Sulfuric Acid

TS203 -JUN-23AUG88

In freezing weather, run engine at least 30 minutes to assure thorough mixing after adding water to battery.

If necessary to replace battery(ies), replacements must meet or exceed the following recommended capacities at -18°C (0°F):

Specification

12 Volt Standard Duty Starter—	
Cold Cranking Amps	640
12 Volt Heavy Duty Starter—Cold	
Cranking Amps	800
24 Volt Standard Duty Starter—	
Cold Cranking Amps	570

Manual Belt Tensioner Adjustment

NOTE: Two types of manual tensioners shown.

NOTE: Inspect belts for cracks, fraying, or stretched-out areas. Replace if necessary.

As a reference check, twist belt in the middle of a 254—305 mm (10—12 in.) span with two fingers. A properly tensioned belt will turn 75—85 degrees. If belt turns more, it needs to be tightened. If belt turns less, it needs to be loosened.

NOTE: If timing gear cover or alternator bracket interfere with installation/centering of belt tension gauge (A), install gauge with face toward engine.

1. Install JDG1341 Belt Tension Gauge (A) on belt, halfway between pulleys as shown. (JDG1341 Belt Tension Gauge available from local John Deere Dealer or Distributor.)
2. Loosen cap screws (B) and (C).
3. Slide alternator or tensioner bracket (D) in slot by hand to remove all excess slack in belt.

IMPORTANT: Do not pry against alternator rear frame.

4. Stretch belt by prying outward on alternator front frame or tensioner bracket. Observing tension gauge, stretch the belt until specified tension is achieved.

Specification

New Belt—Tension..... 470—650 N (105—145 lb-force)
Used Belt—Tension..... 400—580 N (90—130 lb-force)

5. Tighten cap screws (B) and (C).

NOTE: After ten minutes run-in, new belts are considered used. Belt tension must then be rechecked per used belt specifications.

6. Run engine for ten minutes and immediately re-check belt tension per used belt specification above.
7. Reset belt tension as necessary.

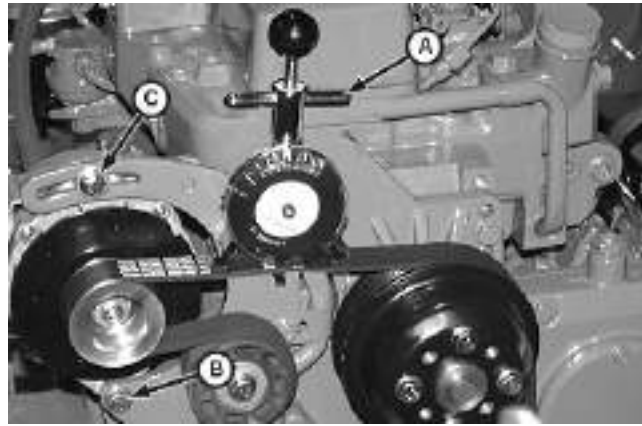

Check Belt Tension

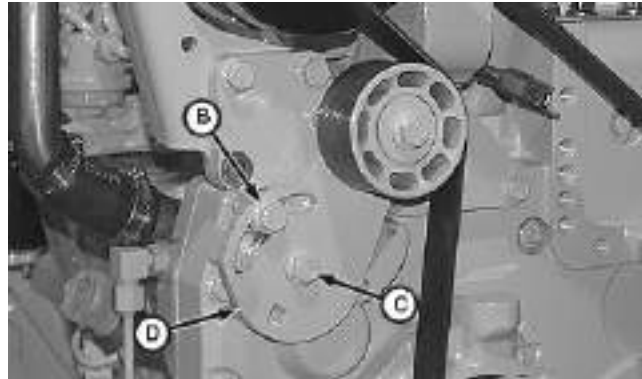

Adjust Belt Tension

- A—Belt Tension Gauge
- B—Cap Screw
- C—Cap Screw
- D—Tensioner Bracket

RG10556 -JUN-21DEC99

RG10557 -JUN-21DEC99

Manual Belt Tensioner Adjustment Using Belt Tension Tool (Alternate Method For Engines Without Auxiliary Drive)

NOTE: The JD1520 Belt Tension Tool may not be compatible with all alternators. In that case, use the preceding method for belt tensioning.

NOTE: Inspect belts for cracks, fraying, or stretched-out areas. Replace if necessary.

As a reference check, twist belt in the middle of a 254—305 mm (10—12 in.) span with two fingers. A properly tensioned belt will turn 75—85 degrees. If belt turns more, it needs to be tightened. If belt turns less, it needs to be loosened.

1. Loosen upper (A) and lower (B) alternator bracket cap screws. Lower cap screw must remain tight enough to prevent excessive alternator play but allow alternator to pivot by hand.
2. Insert JDG1520 Belt Tension Tool (C) behind belt (D) and over alternator mounting screw.

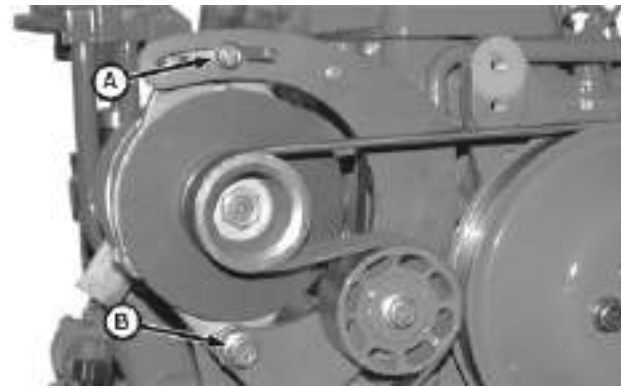

Alternator Bracket and Cap Screws

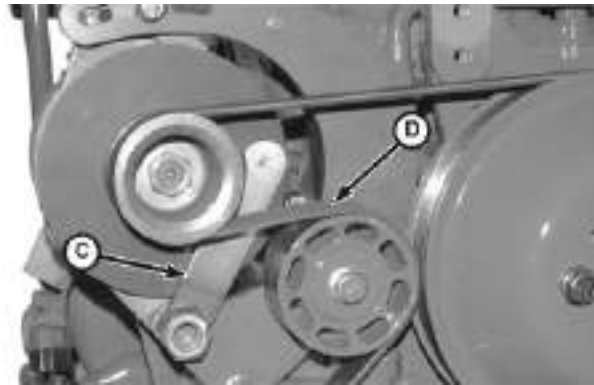

Belt Tension Tool

- A—Upper Alternator Bracket Cap Screw
- B—Lower Alternator Bracket Cap Screw
- C—JDG1520 Belt Tension Tool
- D—Belt

Continued on next page

OUOD002,000016D -19-05JUN02-1/2

- Place torque wrench (C) on belt tensioning tool (B) at 90° to tool. Pivot alternator (A) until desired torque is achieved according to specification using the following table.

Specification

New Belt—Tension..... 470—650 N (105—145 lb-force)
 Used Belt—Tension..... 400—580 N (90—130 lb-force)

JDG1520 Belt Tensioning Tool Torque Table	
Desired Belt Tension N (lb-force)	Applied Torque N•m (lb-ft)
445 (100)	108 (90)
489 (110)	115 (85)
534 (120)	122 (90)
623 (140)	135 (100)

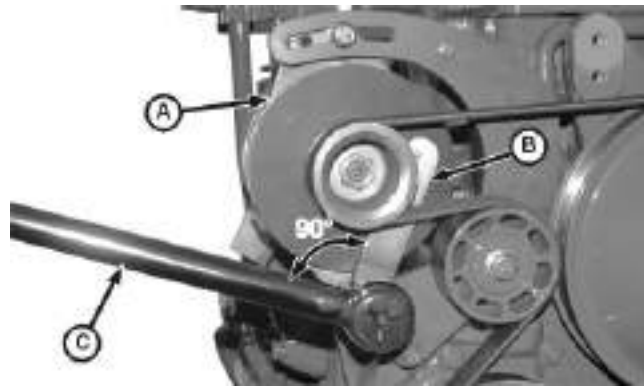

Belt Tension Tool and Torque Wrench

RG11814 -UN-31OCT01

- While holding tension with torque wrench (B), scribe a reference mark (D) on alternator in line with notch (E) on upper alternator bracket.
- Continue to hold tension with torque wrench and tighten upper alternator bracket cap screw.
- Check position of reference mark to see if alternator moved while tightening. If alternator moved, loosen upper alternator bracket cap screw and repeat the tension adjustment procedure.
- Remove belt tension tool and tighten lower alternator bracket cap screw.

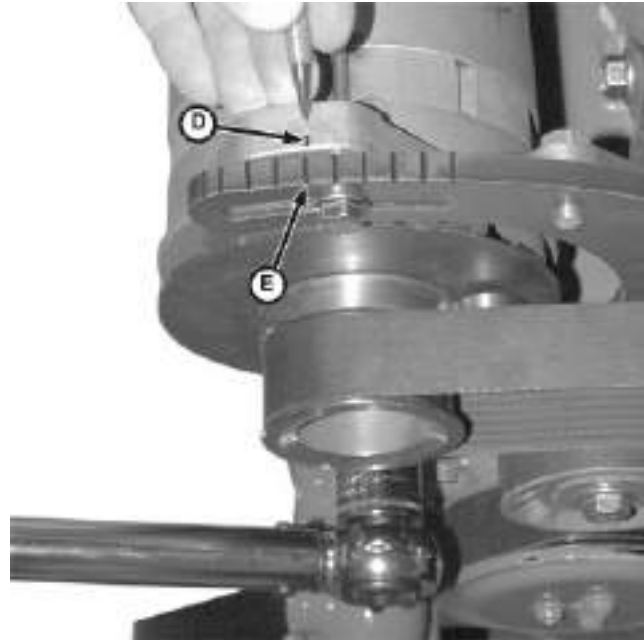

Scribe Reference Mark

RG11815 -UN-31OCT01

- A—Alternator
- B—Belt Tensioning Tool
- C—Torque Wrench
- D—Reference Mark
- E—Alternator Upper Bracket Notch

OUOD002,000016D -19-05JUN02-2/2

Changing Engine Oil and Replacing Filter

IMPORTANT: 6-Cylinder engines with oil pan option codes 1907, 1908, and 1909 require the oil to be changed at every 250 hours regardless of oil specification used.

Your engine is equipped with a special oil filter (A).

NOTE: During break-in, change engine oil and filter for the first time before 100 hours maximum of operation.

After break-in, if John Deere PLUS-50™ or ACEA-E4/E5 engine oil **and** a John Deere special oil filter are used, the oil and filter change interval is 500 hours or every 12 months, whichever comes first.

NOTE: If the above recommendations are not followed, the oil and filter change interval is every 250 hours/ or 6 months. If diesel fuel with a high sulfur content is used, the oil and filter change interval is also reduced. (See DIESEL ENGINE OIL in the "Fuels, Lubricants, and Coolant" section.

OILSCAN™ or OILSCAN PLUS™ is a John Deere sampling program to help you monitor machine performance and identify potential problems before they cause serious damage. OILSCAN™ and OILSCAN PLUS™ kits are available from your John Deere engine distributor or servicing dealer. Oil samples should be taken prior to the oil change. Refer to instructions provided with kit.

To change engine oil and oil filter:

1. Run engine approximately 5 minutes to warm up oil. Shut engine off.
2. Remove oil pan drain plug (arrow).
3. Drain crankcase oil from engine while warm.

NOTE: Drain plug location may vary, depending on the application.



Special Oil Filter



Oil Pan Drain Plug

A—Oil Filter Element

RG11616 -UN-24OCT01

RG4881 -UN-29NOV88

PLUS-50 is a trademark of Deere & Company.
 OILSCAN is a trademark of Deere & Company.
 OILSCAN PLUS is a trademark of Deere & Company.

Continued on next page

OURGP11.000014E -19-06JAN04-1/3

- Turn filter element (A) using a suitable filter wrench to remove. Discard oil filter element.

NOTE: Depending on engine application, oil filter may be located on either side of the engine in a high- or low-mount location.

IMPORTANT: Filtration of oils is critical to proper lubrication. Always change filter regularly. Use filter meeting John Deere performance specifications.

- Apply clean engine oil to the new filter at the inner (B) and outer (C) seals and to filter threads.

- Wipe both sealing surfaces of the header (D, E) with a clean rag. Ensure notches in dust seal (F) are properly installed in the slots in the housing. Replace dust seal if damaged.

IMPORTANT: When installing filter element, **HAND TIGHTEN** only. A filter wrench may be used for **REMOVAL ONLY**. Be sure notches in dust seal (F) are properly installed in the slots in the housing.

- Install and tighten oil filter by hand until firmly against dust seal (F). **DO NOT** apply an extra 3/4 to 1-1/4 turn after gasket contact as done with standard filters.

- Tighten drain plug to specifications.

Specification

Oil Pan Drain Plug With Copper Washer—Torque	70 N•m (52 lb ft)
Oil Pan Drain Plug With O-Ring—Torque	50 N•m (37 lb ft)
Oil Pan Drain Plug With Packing (6068 Engine Code 1961, Steel Oil Pan)—Torque.....	40 N•m (29 lb ft)



Oil Filter And Mounting Header

RG11616 -UN-24OCT01



Oil Filter Seals

RG11617 -UN-24OCT01

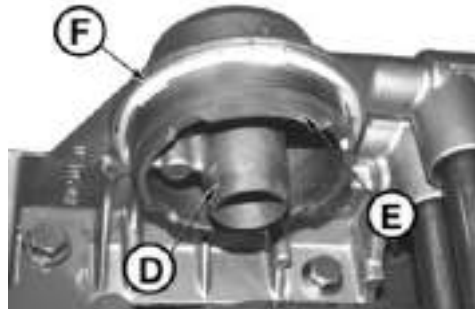

Filter And Mounting Header

RG11618 -UN-24OCT01

- A—Oil Filter Element
- B—Inner Seal
- C—Outer Seal
- D—Sealing Surface On Header
- E—Sealing Surface On Header
- F—Dust Seal

Continued on next page

OURGP11.000014E -19-06JAN04-2/3

- Fill engine crankcase with correct John Deere engine oil through rocker arm cover opening (A) or either side oil filler (B) depending on engine application. (See DIESEL ENGINE OIL in Fuels, Lubricants, and Coolant Section for determining correct engine oil.)

To determine the correct oil fill quantity for your engine, see ENGINE CRANKCASE OIL FILL QUANTITIES in the Specifications Section of this manual.

IMPORTANT: Immediately after completing any oil change, crank engine for 30 seconds without permitting engine to start. This will help insure adequate lubrication to engine components before engine starts.

NOTE: Crankcase oil capacity may vary slightly. ALWAYS fill crankcase within crosshatch marks on dipstick. DO NOT overfill.

- Start engine and run to check for possible leaks.
- Stop engine and check oil level after 10 minutes. Oil level reading should be within crosshatch of dipstick.



Rocker Arm Cover Oil Filler Opening

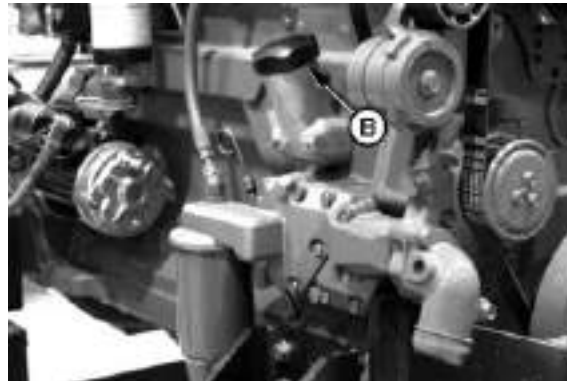

Oil Filler At Side Of Engine

A—Rocker Arm Cover Oil Filler Opening
B—Oil Filler At Side Of Engine

RG11619 -UN-24OCT01

RG11942 -UN-24OCT01

OURGP11,000014E -19-06JAN04-3/3

Checking Crankcase Vent System

Crankcase Vent Tube (If Equipped)

If you operate the engine in dusty conditions, check the system at shorter intervals.

- If equipped, remove and clean crankcase vent tube (A).
- Install the vent tube. Be sure the O-ring fits correctly in the rocker arm cover for elbow adapter. Tighten hose clamp securely.

A—Crankcase Vent Tube

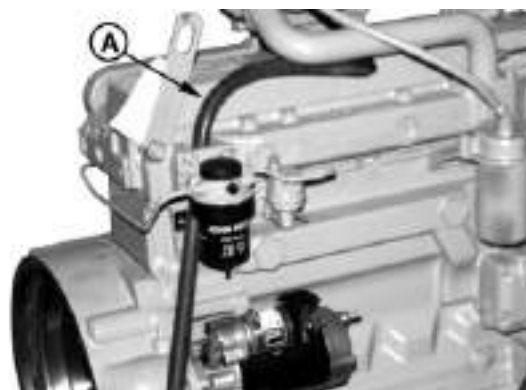

Crankcase Vent Tube

RG8017A -UN-19JUN00

Continued on next page

OURGP11,000014F -19-06JAN04-1/2

Closed Crankcase Ventilation System (If Equipped)

1. Inspect hoses (C, D and G) for kinks, blockage, or other damage.
2. Inspect check valve (H) for damage. (Valve is installed with black end toward crankcase).
3. Verify that crankcase oil drain tube (I) is not plugged.
4. Inspect CCV valve (A) for cracks or other damage.

- A—Closed Crankcase Ventilation (CCV) Valve
- B—Hose, CCV Valve to Intake Manifold
- C—Hose, Valve Cover to CCV Valve
- D—Valve Cover Vent Fitting
- E—Intake Manifold Fitting
- F—Cap Screw, CCV Valve to Bracket
- G—Oil Drain Hose
- H—Check Valve
- I—Crankcase Oil Drain Tube

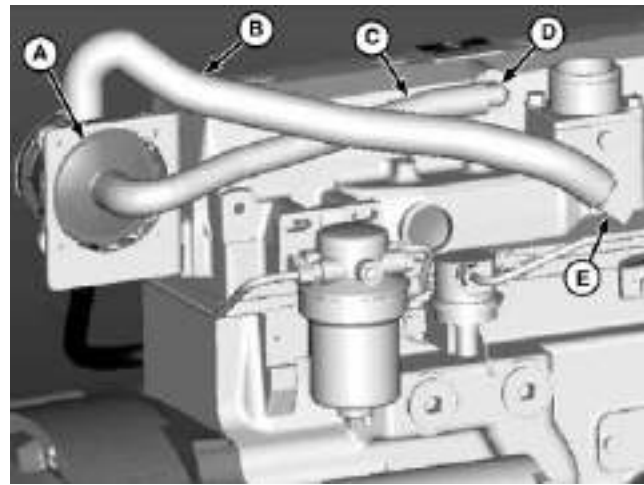

Closed Crankcase Vent

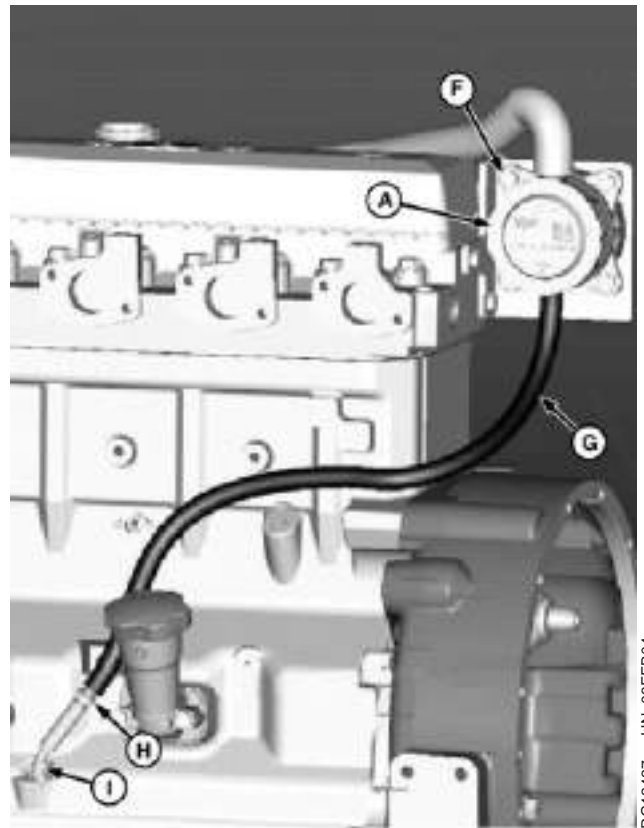

Closed Crankcase Vent

OURGP11.000014F -19-06JAN04-2/2

Checking Air Intake System

IMPORTANT: The air intake system must not leak. Any leak, no matter how small, may result in internal engine damage due to abrasive dirt and dust entering the intake system.

1. Inspect all intake hoses (piping) for cracks. Replace as necessary.
2. Check clamps (A) on piping which connect the air cleaner, engine and, if present, turbocharger. Tighten clamps as necessary. This will help prevent dirt from entering the air intake system through loose connections causing internal engine damage.
3. If engine has a rubber dust unloader valve (B), inspect the valve on bottom of air cleaner for cracks or plugging. Replace as necessary.

IMPORTANT: ALWAYS REPLACE primary air cleaner element when air restriction indicator shows a vacuum of 625 mm (25 in.) H₂O, is torn, or visibly dirty.

4. Test air restriction indicator (C) for proper operation. Replace indicator as necessary.

IMPORTANT: If not equipped with air restriction indicator, replace air cleaner elements at 500 Hours or 12 Months, whichever occurs first.

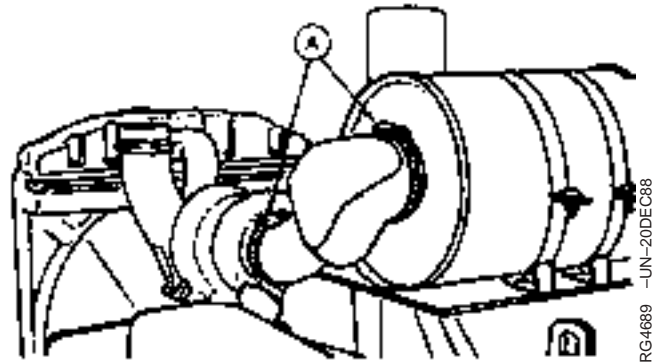

Check Clamps

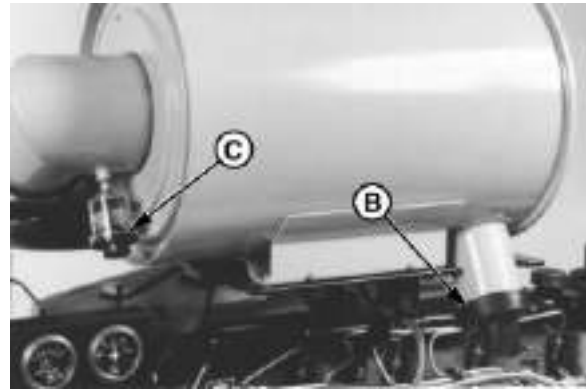

Underloader Valve and Air Restriction Indicator

- A—Clamps
- B—Dust Unloader Valve
- C—Air Restriction Indicator

Replacing Fuel Filter Elements

Engines may be equipped with either a primary fuel filter (or pre-filter) with water bowl and a final filter, or only a final filter including water bowl. Both filters are replaced at the same 500-hour interval.

CAUTION: Escaping fluid under pressure can penetrate the skin causing serious injury. Relieve pressure before disconnecting fuel or other lines. Tighten all connections before applying pressure. Keep hands and body away from pinholes and nozzles which eject fluids under high pressure. Use a piece of cardboard or paper to search for leaks. Do not use your hand.

If any fluid is injected into the skin, it must be surgically removed within a few hours by a doctor familiar with this type injury or gangrene may result. Doctors unfamiliar with this type of injury may call the Deere & Company Medical Department in Moline, Illinois, or other knowledgeable medical source.

1. Close fuel shut-off valve, if equipped.
2. Thoroughly clean fuel filter assemblies and surrounding areas.
3. Disconnect water sensor wiring (if equipped).
4. Loosen drain plugs (C) and drain fuel into a suitable container.

NOTE: Lifting up on retaining ring (A) as it is rotated helps to get it past raised locators.

5. Firmly grasp the retaining ring (A) and rotate it clockwise 1/4 turn (when viewed from the top). Remove ring with filter element (B).
6. Inspect filter mounting base for cleanliness. Clean as required.



High-Pressure Fluids

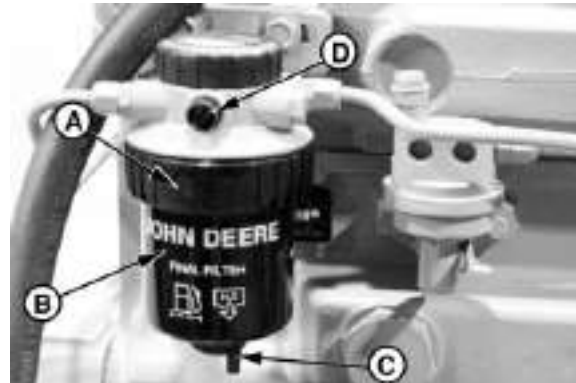

Final Fuel Filter

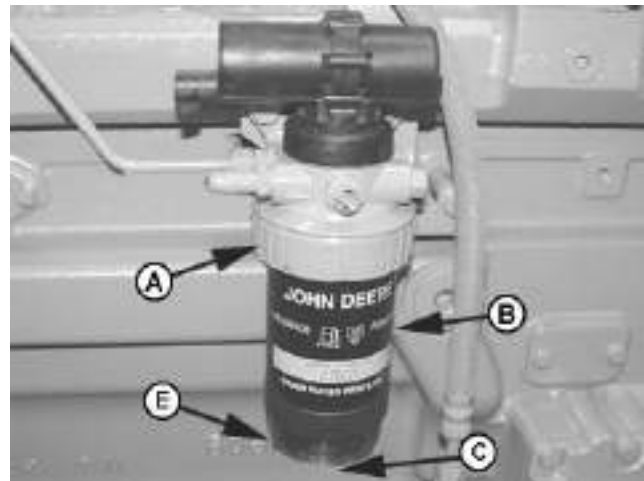

Primary Fuel Filter (or Pre-Filter, If Equipped)

- A—Retaining Ring
- B—Filter Element
- C—Drain Plug
- D—Bleed Plug
- E—Water Bowl

X9811 -UN-23AUG88

RG7721 -UN-15JAN99

RG11954 -UN-05DEC01

Continued on next page

OURGP11.000021F -19-15OCT03-1/2

NOTE: Raised locators on fuel filter canisters must be indexed properly with slots in mounting base for correct installation.

7. Install new filter elements onto mounting bases. Be sure elements are properly indexed and firmly seated on bases. It may be necessary to rotate filters for correct alignment.

If equipped with water separator bowl (E), remove filter element from separator bowl. Drain and clean separator bowl. Dry with compressed air. Install bowl onto new element. Tighten securely.

8. Align keys on filter element with slots in filter base.
9. Install retaining ring onto mounting base making certain dust seal is in place on filter base. Hand tighten ring counterclockwise (about 1/3 turn) until it "snaps" into the detent. DO NOT overtighten retaining ring.

NOTE: The proper installation is indicated when a "click" is heard and a release of the retaining ring is felt.

A plug is provided with the new element for plugging the used element.

10. Reconnect water sensor wiring (if equipped).
11. Open fuel shut-off valve and bleed the fuel system. (See BLEEDING FUEL SYSTEM in Service As Required Section.) Tighten bleed plug (D).

OURGP11,000021F -19-15OCT03-2/2

Checking Belt Tensioner Spring Tension and Belt Wear (Automatic Tensioner)

Belt drive systems equipped with automatic (spring) belt tensioners cannot be adjusted or repaired. The automatic belt tensioner is designed to maintain proper belt tension over the life of the belt. If tensioner spring tension is not within specification, replace tensioner assembly.

OURGP11,0000150 -19-06JAN04-1/3

Checking Belt Wear

The belt tensioner is designed to operate within the limit of arm movement provided by the cast stops (A and B) when correct belt length and geometry is used.

Visually inspect cast stops (A and B) on belt tensioner assembly.

If the tensioner stop on swing arm (A) is hitting the fixed stop (B), check mounting brackets (alternator, belt tensioner, idler pulley, etc.) and the belt length. Replace belt as needed (see REPLACING FAN AND ALTERNATOR BELTS in Service As Required Section).

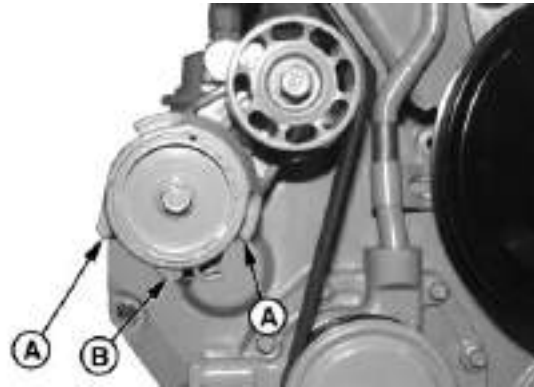

Cast Stops

A—Cast Stops
B—Cast Stop

Continued on next page

OURGP11,0000150 -19-06JAN04-2/3

Checking Tensioner Spring Tension

A belt tension gauge will not give an accurate measure of the belt tension when automatic spring tensioner is used. Measure tensioner spring tension using a torque wrench and procedure outlined below:

1. Release tension on belt using a breaker bar and socket on tension arm. Remove belt from pulleys.

NOTE: While belt is removed, inspect pulleys and bearings. Rotate and feel for hard turning or any unusual sounds. If pulleys or bearings need replacement, see your John Deere dealer.

2. Release tension on tension arm and remove breaker bar.
3. Put a mark (A) on swing arm of tensioner as shown.
4. Measure 21 mm (0.83 in.) from (A) and put a mark (B) on tensioner mounting base.
5. Install torque wrench (C) so that it is aligned with centers of pulley and tensioner. Rotate the swing arm using a torque wrench until marks (A and B) are aligned.
6. Record torque wrench measurement and compare with specification below. Replace tensioner assembly as required.

Specification

Spring Tension—Torque 18-22 N•m (13-16 lb-ft)

NOTE: Threads on belt tensioner roller cap screw are **LEFT-HAND** threads

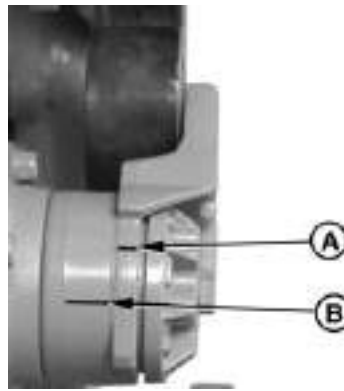

Marks on Tensioner

RG7977 -UN-14NOV97

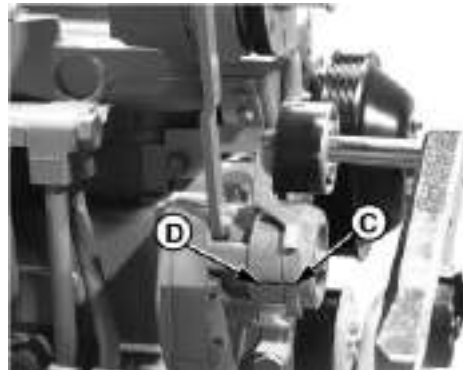

Align Marks

RG8037C -UN-11SEP00

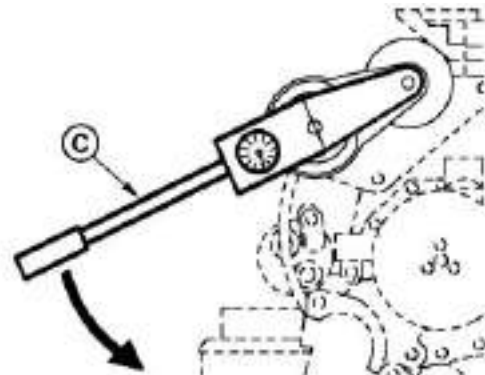

Align Torque Wrench With Pulley and Tensioner

RG12065 -UN-28JAN02

- A—Mark On Swing Arm
- B—Mark On Tensioner Mounting Base
- C—Torque Wrench

OURGP11,0000150 -19-06JAN04-3/3

Checking Engine Electrical Ground Connections

Keep all engine ground connections clean and tight to prevent electrical arcing which can damage electronic components.

Also see precautions in Troubleshooting Section when welding on engine or machine.

OUOD002,0000169 -19-23NOV01-1/1

Checking Cooling System



CAUTION: Explosive release of fluids from pressurized cooling system can cause serious burns.

Shut off engine. Only remove filler cap when cool enough to touch with bare hands. Slowly loosen cap to first stop to relieve pressure before removing completely.

IMPORTANT: Air must be expelled from cooling system when system is refilled. Loosen temperature sending unit fitting at rear of cylinder head or plug in thermostat housing to allow air to escape when filling system. Retighten fitting or plug when all the air has been expelled.

1. Visually check entire cooling system for leaks. Tighten all clamps securely.
2. Thoroughly inspect all cooling system hoses for hard, flimsy, or cracked condition. Replace hoses if any of the above conditions are found.
3. Inspect the coolant pump for wear or leakage.



High-Pressure Fluids

TS281 -JUN-23AUG88

OURGP11,0000151 -19-06JAN04-1/1

Replenishing Supplemental Coolant Additives (SCAs) Between Coolant Changes

IMPORTANT: Do not add supplemental coolant additives when the cooling system is drained and refilled with John Deere COOL-GARD™

NOTE: If system is to be filled with coolant that does not contain SCAs, the coolant must be precharged. Determine the total system capacity and premix with 3% John Deere Coolant Conditioner.

Through time and use, the concentration of coolant additives is gradually depleted during engine operation. Periodic replenishment of inhibitors is required, even when John Deere COOL-GARD™ is used. The cooling system must be recharged with additional supplemental coolant additives available in the form of liquid coolant conditioner.

Maintaining the correct coolant conditioner concentration (SCAs) and freeze point is essential in your cooling system to protect against rust, liner pitting and corrosion, and freeze-ups due to incorrect coolant dilution.

John Deere LIQUID COOLANT CONDITIONER is recommended as a supplemental coolant additive in John Deere engines.

DO NOT mix one brand of SCA with a different brand.

Test the coolant solution at 500 hours or 12 months of operation using either John Deere coolant test strips or a COOLSCAN™ or COOLSCAN PLUS™ analysis. If a COOLSCAN™ or COOLSCAN PLUS™ analysis is not available, recharge the system per instructions printed on label of John Deere Liquid Coolant Conditioner.

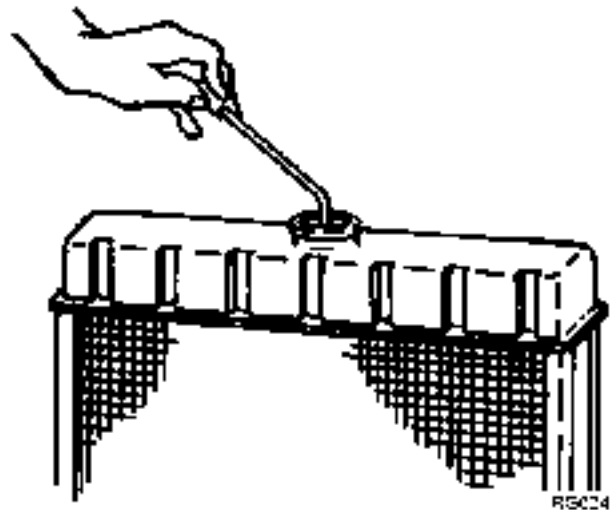

Radiator Coolant Check

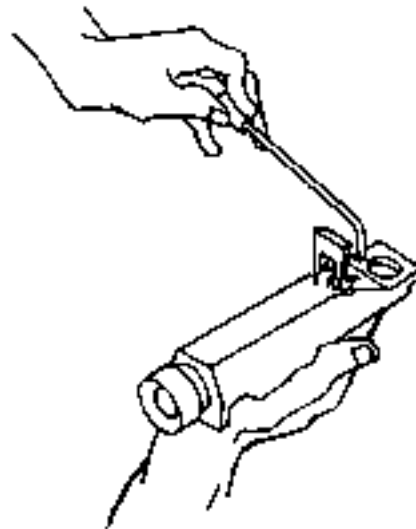

JT07298 Coolant/Battery Tester

COOL-GARD is a trademark of Deere & Company
COOLSCAN is a trademark of Deere & Company
COOLSCAN PLUS is a trademark of Deere & Company

Continued on next page

DPSG,OUOD002,1921 -19-25FEB03-1/2

IMPORTANT: ALWAYS maintain coolant at correct level and concentration. DO NOT operate engine without coolant even for a few minutes.

If frequent coolant makeup is required, the glycol concentration should be checked with JT07298 Coolant/Battery Tester to ensure that the desired freeze point is maintained. Follow manufacturer's instructions provided with Coolant/Battery Tester.

Add the manufacturer's recommended concentration of supplemental coolant additive. DO NOT add more than the recommended amount.

The use of non-recommended supplemental coolant additives may result in additive drop-out and gelation of the coolant.

If other coolants are used, consult the coolant supplier and follow the manufacturer's recommendation for use of supplemental coolant additives.

See DIESEL ENGINE COOLANTS AND SUPPLEMENTAL ADDITIVE INFORMATION for proper mixing of coolant ingredients before adding to the cooling system.

DPSG,OUOD002,1921 -19-25FEB03-2/2

Testing Diesel Engine Coolant

Maintaining adequate concentrations of glycol and inhibiting additives in the coolant is critical to protect the engine and cooling system against freezing, corrosion, and cylinder liner erosion and pitting.

Test the coolant solution at intervals of 12 months or less and whenever excessive coolant is lost through leaks or overheating.

Coolant Test Strips

Coolant test strips are available from your John Deere dealer. These test strips provide a simple, effective method to check the freeze point and additive levels of your engine coolant.

Compare the results to the supplemental coolant additive (SCA) chart to determine the amount of inhibiting additives in your coolant and whether more John Deere COOLANT CONDITIONER should be added.

COOLSCAN Or COOLSCAN PLUS

For a more thorough evaluation of your coolant, perform a COOLSCAN or COOLSCAN PLUS analysis. See your John Deere dealer for information about COOLSCAN or COOLSCAN PLUS.

OUOD002,0000175 -19-23NOV01-1/1

Pressure Testing Cooling System

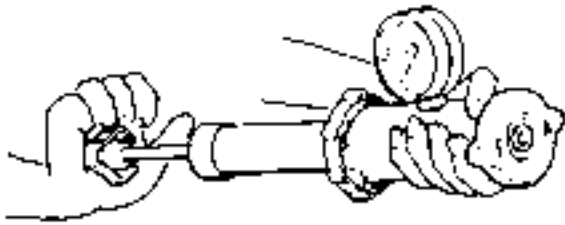

Test Radiator Cap

RG6657 -JUN-20JAN93

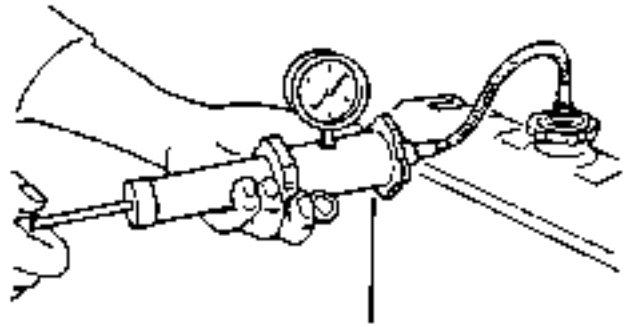

Test Cooling System

RG6658 -JUN-20JAN93

CAUTION: Explosive release of fluids from pressurized cooling system can cause serious burns.

Shut off engine. Only remove filler cap when cool enough to touch with bare hands. Slowly loosen cap to first stop to relieve pressure before removing completely.

NOTE: These tests apply only to John Deere radiators. For other brands, see manufacturers literature.

Test Radiator Cap

1. Remove radiator cap and attach to D05104ST Tester as shown.
2. Pressurize cap to specification listed. Gauge should hold pressure for 10 seconds at least to pressure listed if cap is acceptable.

If gauge does not hold pressure, replace radiator cap.

Specification

Radiator Cap Holding Pressure
(Not Opening For 10
Seconds)—Pressure..... 70 kPa (0.7 bar) (10 psi)

3. Remove the cap from gauge, turn it 180°, and retest cap. This will verify that the first measurement was accurate.

Test Cooling System

NOTE: Engine should be warmed up to test overall cooling system.

1. Allow engine to cool, then carefully remove radiator cap.
2. Fill radiator with coolant to the normal operating level.

IMPORTANT: DO NOT apply excessive pressure to cooling system, doing so may damage radiator and hoses.

3. Connect gauge and adapter to radiator filler neck. Pressurize cooling system to specification listed for radiator cap.
4. With pressure applied, check all cooling system hose connections, radiator, and overall engine for leaks.

If leakage is detected, correct as necessary and pressure test system again.

If no leakage is detected, but the gauge indicated a drop in pressure, coolant may be leaking internally within the system or at the block-to-head gasket. Have your engine distributor or servicing dealer correct this problem immediately.

Checking and Adjusting Engine Speeds

If equipped with a tachometer (A) on the instrument panel, observe tachometer reading to verify engine speeds. (Refer to ENGINE POWER RATINGS AND FUEL SYSTEM SPECIFICATIONS in Specifications Section later in this manual for engine speed specifications.) If engine speed adjustment is required, see your authorized servicing dealer or engine distributor.

A—Tachometer

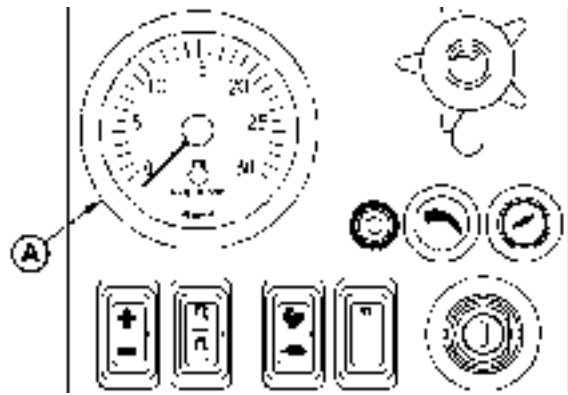

Using Tachometer to Check Engine Speeds

RG12607 -UN-24OCT02

OURGP12,00001DB -19-25FEB03-1/1

Lubrication & Maint./2000 Hour/24 Month

Adjusting Variable Speed (Droop) — 4.5 L “270” Generator Set Engines Only

1. Warm engine to normal operating temperature.
2. When necessary, disconnect throttle linkage or cable.
3. Adjust slow idle (C) and adjust fast idle (B) speed when necessary.
4. Run engine at fast idle, then apply load until reaching rated speed.
5. Check power. Adjust with the screw (A) if needed.
6. Remove load from engine.
7. Again check and adjust fast idle if screw (A) has been turned.
8. Repeat procedure until both the engine power and the fast idle speed are correct.
9. Reinstall throttle linkage if previously removed.

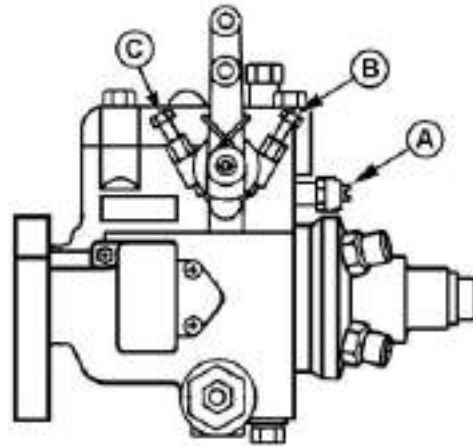

Droop Adjustment Screw

A—Adjustment Screw
B—Fast Idle Adjustment
C—Slow Idle Adjustment

RG12066 -JUN-29JAN02

OURGP12.00001ED -19-14MAR03-1/1

Checking Crankshaft Vibration Damper (6-Cylinder Engine Only)

1. Remove belts (shown removed).
2. Grasp vibration damper with both hands and attempt to turn it in both directions. If rotation is felt, damper is defective and should be replaced.

IMPORTANT: The vibration damper assembly is not repairable and should be replaced every 4500 hours or 60 months, whichever occurs first.

3. Check vibration damper radial runout by positioning a dial indicator (A) so probe contacts damper outer diameter.
4. With engine at operating temperature, rotate crankshaft using either JD281A, JDE81-4, or JDE83 Flywheel Turning Tool.
5. Note dial indicator reading. If runout exceeds specifications given below, replace vibration damper.

Specification

Vibration Damper—Maximum
Radial Runout..... 1.50 mm (0.060 in.)



Grasp Vibration Damper

RG8018 -UN-15JAN99



Check Runout

RG7508 -UN-23NOV97

RG, RG34710, 5585 -19-12NOV01-1/1

Flushing and Refilling Cooling System

CAUTION: Explosive release of fluids from pressurized cooling system can cause serious burns.

Shut off engine. Only remove filler cap when cool enough to touch with bare hands. Slowly loosen cap to first stop to relieve pressure before removing completely.

NOTE: When John Deere COOL-GARD is used, the drain interval is 3000 hours or 36 months. The drain interval may be extended to 5000 hours or 60 months of operation, **provided that the coolant is tested annually AND additives are replenished, as needed, by adding a supplemental coolant additive (SCA).**

If COOL-GARD is not used, the flushing interval is 2000 hours or 24 months of operation.

Drain old coolant, flush the entire cooling system, test thermostats, and fill with recommended clean coolant per the following procedure.

1. Pressure test entire cooling system and pressure cap if not previously done. (See PRESSURE TESTING COOLING SYSTEM, in the Lubrication and Maintenance/500 Hour/12 Month Section.)
2. Slowly open the engine cooling system filler cap or radiator cap (A) to relieve pressure and allow coolant to drain faster.



High-Pressure Fluids

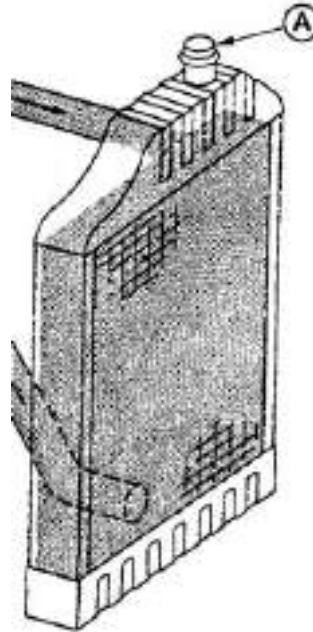

Radiator Cap

TSS281 -UN-23AUG88

RG12833 -UN-13FEB03

Continued on next page

OURGP11,0000221 -19-15OCT03-1/4

3. All Except 4045HF475 and 6068HF475 Engines:

Open engine block drain valve (A) on left side of engine. Drain all coolant from engine block.

NOTE: On 475 engines, the engine block drain valve is located behind the fuel rail, and is not easily accessible.

4045HF475 and 6068HF475 Engines: Open drain plug (B) or (C) on oil cooler housing. Drain all coolant from engine block.

NOTE: These engines use several different oil filter adapters. Use either drain plug (B) or (C) to drain coolant, whichever is more accessible for the oil filter adapter on your engine.

4. Open radiator drain valve. Drain all coolant from radiator.

5. Remove thermostats at this time, if not previously done. Install cover (without thermostats) using old gasket and tighten cap screws to 47 N•m (35 lb-ft).

6. Test thermostat opening temperature. (See Inspecting Thermostats And Testing Opening Temperature in Service As Required Section.)

7. Close all drain valves after coolant has drained.

CAUTION: Do not run engine longer than 10 minutes. Doing so may cause engine to overheat which may cause burns when radiator water is draining.

8. Fill the cooling system with clean water. Run the engine about 10 minutes to stir up possible rust or sediment.

9. Stop engine, pull off lower radiator hose and remove radiator cap. Immediately drain the water from system before rust and sediment settle.

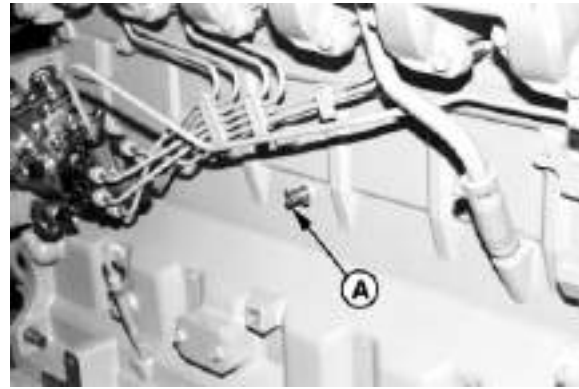

RG8019A -UN-19JUN00

Engine Block Drain Valve- Except 475 Engines

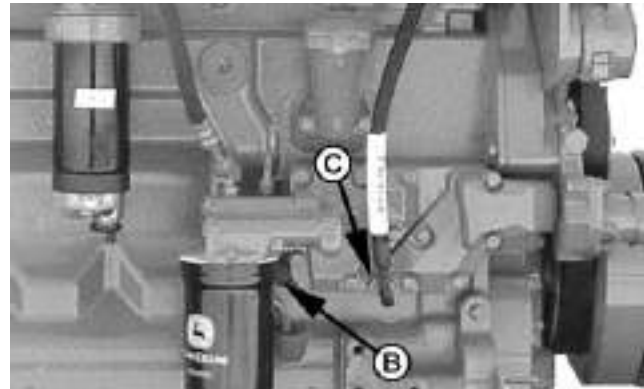

RG12223 -UN-11JUN02

Engine Block Coolant Drain Plug- 475 Engines

- A—Engine Block Drain Valve
- B—Engine Block Drain Plug
- C—Engine Block Drain Plug

10. After draining water, close drain valves. Reinstall radiator cap and radiator hose and clamp. Fill the cooling system with clean water and a heavy duty cooling system cleaner such as Fleetguard® RESTORE™ and RESTORE PLUS™. Follow manufacturer's directions on label.
11. After cleaning the cooling system, drain cleaner and fill with water to flush the system. Run the engine about 10 minutes, remove radiator cap and pull off lower radiator hose to drain out flushing water.
12. Close all drain valves on engine and radiator. Reinstall radiator hose and tighten clamps securely. Install thermostats using a new gasket. (See TESTING THERMOSTATS OPENING TEMPERATURE later in this section.)

IMPORTANT: Air must be expelled from cooling system when system is refilled. Loosen temperature sending unit fitting at rear of cylinder head or plug in thermostat housing to allow air to escape when filling system. Retighten fitting or plug after filling cooling system.

13. Add coolant to radiator until coolant touches bottom of filler neck. (See specification for capacity.) Install radiator cap.

Specification

4.5 L Engine—Coolant Capacity	8.5 L (9 qt)
6.8 L Engine—Coolant Capacity	11.3 L (12 qt)

14. Run engine until it reaches operating temperature. This mixes the solution uniformly and circulates it through the entire system. The normal engine coolant temperature range is 82°—94°C (180° — 202°F).
15. After running engine, check coolant level and entire cooling system for leaks.

*Fleetguard is a trademark of Cummins Engine Company, Inc.
RESTORE is a trademark of Fleetguard.
RESTORE PLUS is a trademark of Fleetguard.*

16. Inspect the fan belt for wear and check belt tension. (See Checking Belt Tensioner Spring Tension and Belt Wear in Lubrication and Maintenance 500 Hour/12 Month section.

OURGP11,0000221 -19-15OCT03-4/4

Testing Thermostats Opening Temperature

To Remove Thermostat(s)

CAUTION: Explosive release of fluids from pressurized cooling system can cause serious burns. **DO NOT** drain coolant until it has cooled below operating temperature. Always loosen radiator pressure cap or drain valve slowly to relieve pressure.



High Pressure Fluids

TS281 -UN-23AUG88

1. Visually inspect area around thermostat housing for leaks.
2. Remove radiator pressure cap and partially drain cooling system.
3. Remove thermostat cover-to-coolant pump tube (A) and seal.

A—Cover-To-Coolant Pump Tube



RG8115A -UN-15JAN98

Thermostat Cover-to-Coolant Pump Tube

DPSG, RG34710,112 -19-23NOV01-1/5

4. Remove thermostat cover (B) with gasket.
5. Remove thermostat(s)
6. Remove and discard all gasket material. Clean gasket surfaces.
7. Clean and check cover for cracks or damage.

B—Thermostat Cover

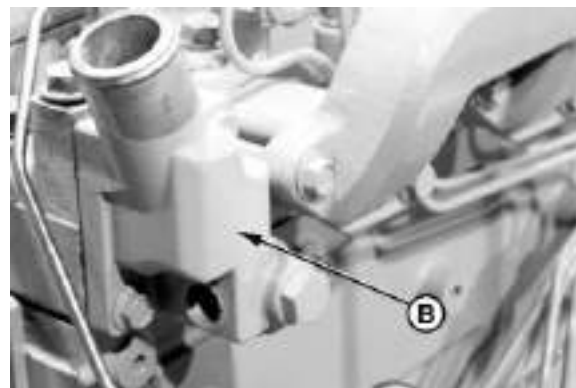

RG7921A -UN-13NOV97

Thermostat Cover

Continued on next page

DPSG, RG34710,112 -19-23NOV01-2/5

Testing Thermostats Opening Temperature

1. Remove thermostat(s).
2. Visually inspect thermostat(s) for corrosion or damage. If dual thermostats, replace as a matched set as necessary.

CAUTION: DO NOT allow thermostat or thermometer to rest against the side or bottom of container when heating water. Either may rupture if overheated.

3. Suspend thermostat and a thermometer in a container of water.
4. Stir the water as it heats. Observe opening action of thermostat and compare temperatures with the specification given in chart below.

NOTE: Due to varying tolerances of different suppliers, initial opening and full open temperatures may vary slightly from specified temperatures.

THERMOSTAT TEST SPECIFICATIONS

Rating	Initial Opening (Range)	Full Open (Nominal)
71°C (160°F)	69—72°C (156—162°F)	84°C (182°F)
77°C (170°F)	74—78°C (166—172°F)	89°C (192°F)
82°C (180°F)	80—84°C (175—182°F)	94°C (202°F)
89°C (192°F)	86—90°C (187—194°F)	101°C (214°F)
90°C (195°F)	89—93°C (192—199°F)	103°C (218°F)
92°C (197°F)	89—93°C (193—200°F)	105°C (221°F)
96°C (205°F)	94—97°C (201—207°F)	100°C (213°F)
99°C (210°F)	96—100°C (205—212°F)	111°C (232°F)

5. Remove thermostat and observe its closing action as it cools. In ambient air the thermostat should close completely. Closing action should be smooth and slow.
6. Replace any defective thermostat. On a dual thermostat engine, replace both thermostats.

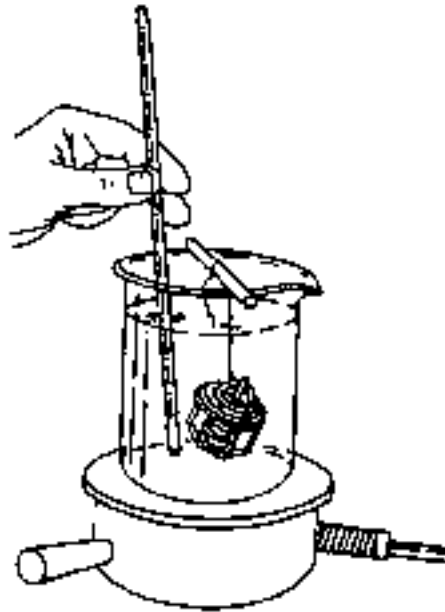

Testing Thermostat Opening Temperature

RG5971 -JUN-23NOV97

Continued on next page

DPSG, RG34710, 112 -19-23NOV01-3/5

To Install Thermostats

IMPORTANT: Install manifold gasket so that smaller (round) holes are at lower left and upper right corners of manifold (matching studs A).

1. Clean all gasket material from thermostat cover and housing mounting surfaces.
2. Using guide studs (A) to keep gasket in place, install a new gasket on cylinder head.
3. Install thermostat(s) with jiggle wire facing up in the 12 o'clock position.
4. Using a screwdriver to hold thermostat(s) in place, install thermostat(s) and coolant manifold/thermostat cover.
5. Tighten cover cap screws to 70 N•m (52 lb-ft).
6. Lubricate new O-ring with PT507 Multi-Purpose Grease. Install seal (B) in thermostat cover.

A—Guide Studs
B—Seal

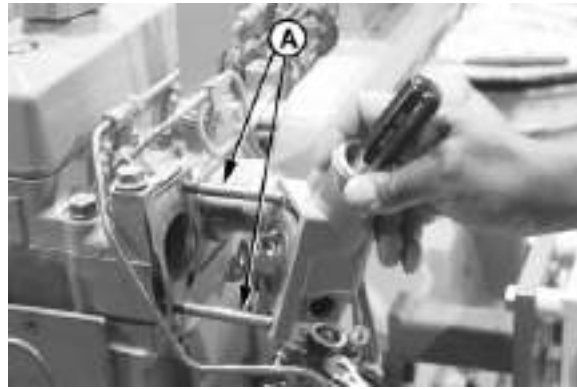

Installing Thermostat Cover

RG7614A -UN-06NOV97



Thermostat Cover Seal

RG7921B -UN-13NOV97

DPSG, RG34710,112 -19-23NOV01-4/5

7. Install coolant manifold/thermostat cover-to-coolant pump tube (C). Tighten clamps.
8. If not already done, fill cooling system and check for leaks.

IMPORTANT: Air must be expelled from cooling system when filling. Loosen temperature sending unit fitting at rear of cylinder head or plug in thermostat housing to allow air to escape when filling system. Tighten fitting or plug when all air has been expelled.



Cover-To-Coolant Pump Tube

RG8115B -UN-15JAN98

C—Cover-To-Coolant Pump Tube

DPSG, RG34710,112 -19-23NOV01-5/5

Check and Adjust Valve Clearance (All Engines Except 4045HF475 And 6068HF475)

CAUTION: To prevent accidental starting of engine while performing valve adjustments, always disconnect **NEGATIVE (—)** battery terminal.

IMPORTANT: Valve clearance **MUST BE** checked and adjusted with engine **COLD**.

1. Remove rocker arm cover and crankcase ventilator tube.

IMPORTANT: Visually inspect contact surfaces of valve tips and rocker arm wear pads. Check all parts for excessive wear, breakage, or cracks. Replace parts that show visible damage.

Rocker arms that exhibit excessive valve clearance should be inspected more thoroughly to identify damaged parts.

2. Remove plastic plugs or cover plate from engine timing/rotation hole (A) and timing pin hole (B).

NOTE: Some engines are equipped with flywheel housings which do not allow use of an engine flywheel rotation tool. These engines may be rotated from front nose of engine, using JDG966 Crankshaft Front/Rear Rotation Adapter.

3. Using JDE83 or JDG281AFlywheel Turning Tool, rotate engine flywheel in running direction (clockwise viewed from front) until No. 1 cylinder is at TDC compression stroke. Insert JDG1571 Timing Pin in flywheel.

If No.1 cylinder rocker arms are loose, the engine is at No. 1 TDC compression.

If No. 1 cylinder rocker arms are not loose, rotate engine one full revolution (360°) to No. 1 TDC compression.

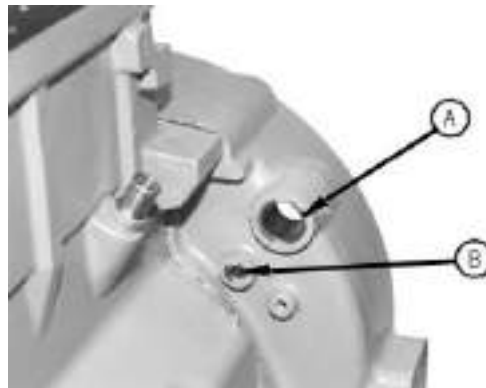

Flywheel Housing Timing Holes

A—Timing/Rotation Hole
B—Timing Pin Hole

RG7408 -UN-06AUG96

Continued on next page

DPSG, RG41165, 137 -19-12MAR03-1/5

4. With engine lock-pinned at TDC of No. 1 piston's compression stroke, check valve clearance to following specifications. (Use sequence for 4-cylinder or 6-cylinder engines as outlined on next page.)

Specification

Intake Valve Clearance For	
Checking (Rocker Arm-to-Valve	
Tip) (Engine Cold)—Clearance	0.31—0.38 mm (0.012—0.015 in.)
Exhaust Valve Clearance For	
Checking (Rocker Arm-to-Valve	
Tip) (Engine Cold)—Clearance	0.41—0.48 mm (0.016—0.019 in.)

DPSG, RG41165, 137 -19-12MAR03-2/5

5. If valves need adjusting, use the appropriate valve clearance adjustment procedure on the next page and adjust to specifications below. Loosen the jam nut (A) on rocker arm adjusting screw. Turn adjusting screw until feeler gauge slips with a slight drag. Hold the adjusting screw from turning with screwdriver and tighten jam nut to specifications. Recheck clearance again after tightening jam nut. Readjust clearance as necessary.

Specification

Intake Valve Clearance For	
Adjusting (Rocker Arm-to-Valve	
Tip) (Engine Cold)—Clearance	0.36 mm (0.014 in.)
Exhaust Valve Clearance For	
Adjusting (Rocker Arm-to-Valve	
Tip) (Engine Cold)—Clearance	0.46 mm (0.018 in.)
Rocker Arm Adjusting Screw Jam	
Nut—Torque	27 N•m (20 lb-ft)

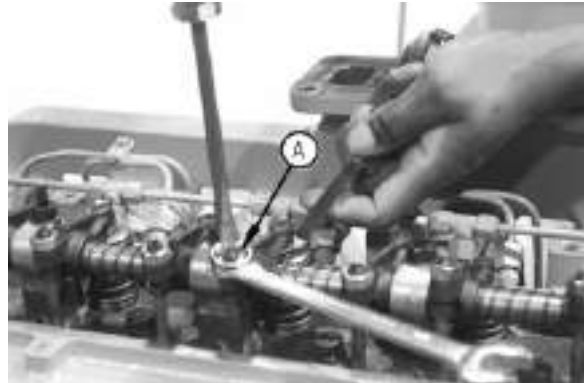

RG7409 -UN-06AUG96

Adjusting Valves

A—Adjusting Screw Jam Nut

6. Replace rocker arm cover and crankcase ventilator tube.

Continued on next page

DPSG, RG41165, 137 -19-12MAR03-3/5

4-Cylinder Engine:

NOTE: Firing order is 1-3-4-2.

1. Using JDE81-4 Timing Pin, lock No. 1 piston at TDC compression stroke (B).
2. Adjust valve clearance on No. 1 and 3 exhaust valves and No. 1 and 2 intake valves.
3. Turn crankshaft 360°. Lock No. 4 piston at TDC compression stroke (C).
4. Adjust valve clearance on No. 2 and 4 exhaust valves and No. 3 and 4 intake valves.

- A—Front of Engine
- B—No. 1 Piston TDC Compression
- C—No. 4 Piston TDC Compression
- E—Exhaust Valve
- I—Intake Valve

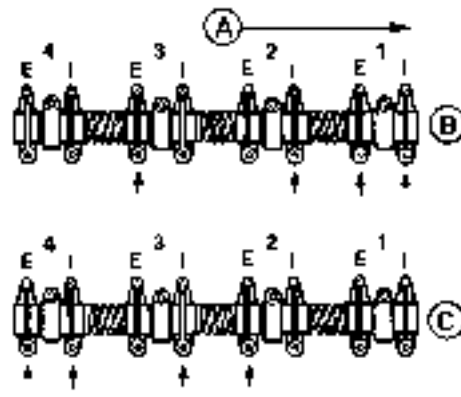

4-Cylinder Engine Valve Adjustment

RG4776 -UN-31OCT97

DPSG.RG41165,137 -19-12MAR03-4/5

6-Cylinder Engine:

NOTE: Firing order is 1-5-3-6-2-4.

1. Lock No. 1 piston at TDC compression stroke (B).
2. Adjust valve clearance on No. 1, 3 and 5 exhaust valves and No. 1, 2, and 4 intake valves.
3. Turn crankshaft 360°. Lock No. 6 piston at TDC compression stroke (C).
4. Adjust valve clearance on No. 2, 4 and 6 exhaust valves and No. 3, 5, and 6 intake valves.

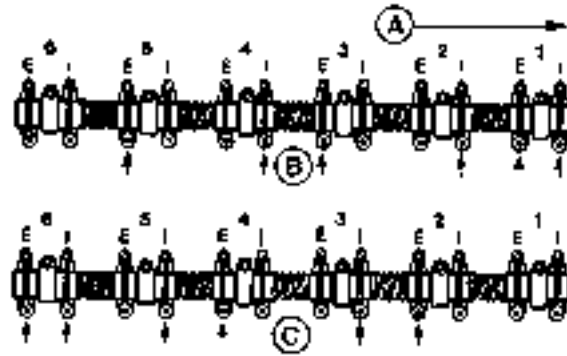

6-Cylinder Engine Valve Adjustment

- A—Front of Engine
- B—No. 1 Piston TDC Compression
- C—No. 6 Piston TDC Compression
- E—Exhaust Valve
- I—Intake Valve

RG4777 -UN-31OCT97

DPSG.RG41165,137 -19-12MAR03-5/5

Check and Adjust Valve Clearance (4045HF475 And 6068HF475 Engines)



CAUTION: To prevent accidental starting of engine while performing valve adjustments, always disconnect **NEGATIVE (—)** battery terminal.

IMPORTANT: Valve clearance **MUST BE** checked and adjusted with engine **COLD**.

1. Remove rocker arm cover and crankcase ventilator tube.

IMPORTANT: Visually inspect contact surfaces of valve tips, bridges and rocker arm wear pads. Check all parts for excessive wear, breakage, or cracks. Replace parts that show visible damage.

Rocker arms that exhibit excessive valve clearance should be inspected more thoroughly to identify damaged parts.

2. Remove plastic plugs or cover plate from engine timing/rotation hole (A) and timing pin hole (B).

NOTE: Some engines are equipped with flywheel housings which do not allow use of an engine flywheel rotation tool. These engines with straight nose crankshafts may be rotated from front nose of engine, using JDG966 Crankshaft Front/Rear Rotation Adapter.

3. Using JDE83 or JDG820 Flywheel Turning Tool, rotate engine flywheel in running direction (clockwise viewed from front) until No. 1 (front) cylinder is at TDC compression stroke. Insert JDG1571 or JDE81-4 Timing Pin in flywheel.

If No. 1 cylinder rocker arms are loose, the engine is at No. 1 TDC compression.

If No. 1 cylinder rocker arms are not loose, rotate engine one full revolution (360°) to No. 1 TDC compression.



RG12168 -JUN-03JUL02

Flywheel Housing Timing Holes

A—Timing/Rotation Hole
B—Timing Pin Hole

- With engine lock-pinned at TDC of No. 1 piston's compression stroke, check valve clearance to following specifications. (Use sequence for 4-cylinder or 6-cylinder engines as outlined on next page.)

Specification

Intake Valve Clearance Checking (Rocker Arm-to-Bridge) (Engine Cold)—Clearance	0.31—0.38 mm (0.012—0.015 in.)
Exhaust Valve Clearance Checking (Rocker Arm-to-Bridge) (Engine Cold)—Clearance.....	0.41—0.48 mm (0.016—0.019 in.)

OUO1089,0000208 -19-12MAR03-2/5

- If valves need adjusting, use the appropriate valve clearance adjustment procedure on the next page and adjust to specifications below. Loosen the jam nut (A) on rocker arm adjusting screw. Turn adjusting screw until feeler gauge slips with a slight drag. Hold the adjusting screw from turning with screwdriver and tighten jam nut to specifications. Recheck clearance again after tightening jam nut. Readjust clearance as necessary.

Specification

Intake Valve Clearance Adjustment (Rocker Arm-to-Bridge) (Engine Cold)— Clearance	0.36 mm (0.014 in.)
Exhaust Valve Clearance Adjustment (Rocker Arm-to-Bridge) (Engine Cold)— Clearance	0.46 mm (0.018 in.)
Rocker Arm Adjusting Screw Jam Nut—Torque	27 N•m (20 lb-ft)

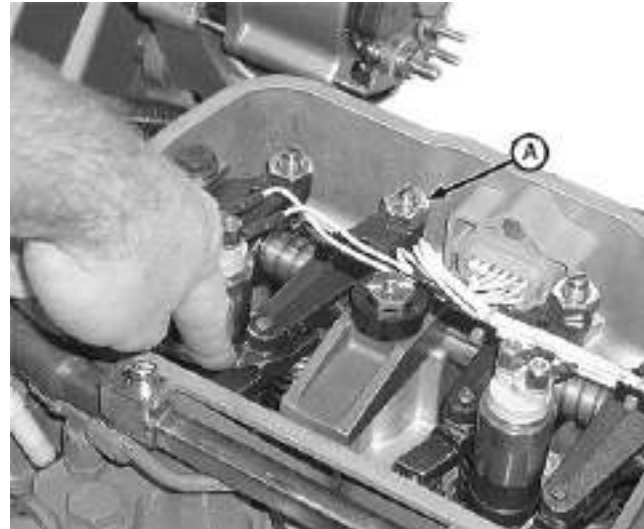

RG12169 -UN-03JUL02

Adjusting Valves

A—Adjusting Screw Jam Nut

NOTE: While rocker arm cover is removed, test glow plugs. (See following procedure.)

- Install rocker arm cover and crankcase ventilator tube.
- Reconnect battery terminal.

Continued on next page

OUO1089,0000208 -19-12MAR03-3/5

4-Cylinder Engine:

NOTE: Firing order is 1-3-4-2.

1. Using JDG1571 or JDE81-4 Timing Pin, lock No. 1 piston at TDC compression stroke (B).
2. Adjust valve clearance on No. 1 and 3 exhaust valves and No. 1 and 2 intake valves.
3. Turn crankshaft 360°. Lock No. 4 piston at TDC compression stroke (C).
4. Adjust valve clearance on No. 2 and 4 exhaust valves and No. 3 and 4 intake valves.

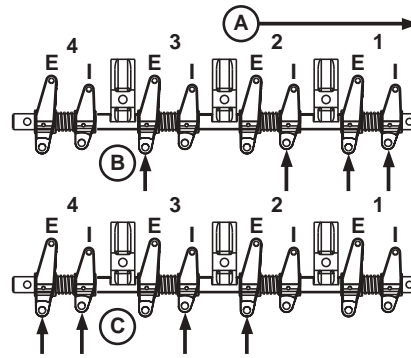

4-Cylinder Valve Adjustment

- A—Front of Engine
- B—No. 1 Piston TDC Compression
- C—No. 4 Piston TDC Compression
- E—Exhaust Valve
- I—Intake Valve

RG12357 -JUN-29MAY02

OUO1089,0000208 -19-12MAR03-4/5

6-Cylinder Engine:

NOTE: Firing order is 1-5-3-6-2-4.

1. Lock No. 1 piston at TDC compression stroke (B).
2. Adjust valve clearance on No. 1, 3 and 5 exhaust valves and No. 1, 2, and 4 intake valves.
3. Turn crankshaft 360°. Lock No. 6 piston at TDC compression stroke (C).
4. Adjust valve clearance on No. 2, 4 and 6 exhaust valves and No. 3, 5, and 6 intake valves.

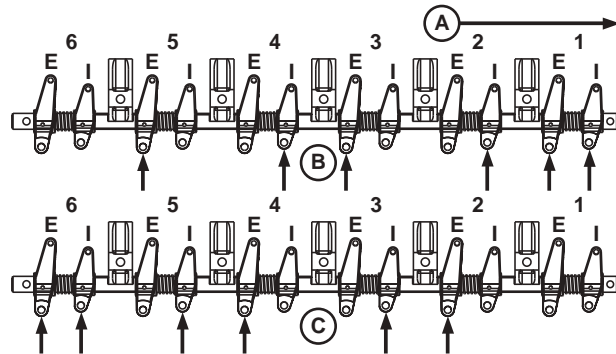

6-Cylinder Valve Adjustment

- A—Front of Engine
- B—No. 1 Piston TDC Compression
- C—No. 6 Piston TDC Compression
- E—Exhaust Valve
- I—Intake Valve

RG12170 -JUN-21MAY02

OUO1089,0000208 -19-12MAR03-5/5

Test Glow Plugs for Continuity (4045HF475 And 6068HF475 Engines)



CAUTION: To prevent accidental starting of engine while performing this test, always disconnect **NEGATIVE (—)** battery terminal.

While checking valve clearance with rocker arm cover removed, check each glow plug for continuity using a multimeter.

Check continuity between glow plug and ground on cylinder head. If resistance is infinite (no current), the glow plug is damaged and must be replaced.

Install new glow plugs and torque to specifications.

Specification

Glow Plug—Torque 12—18 N•m (9—13 lb-ft)

Reinstall rocker arm cover and crankcase ventilator tube.

OUOD006,0000018 -19-05JUN02-1/1

Service as Required

Additional Service Information

This is not a detailed service manual. If you want more detailed service information, use the Publications Information in the back of this manual to order a component technical manual.



Component Technical Manual

RG4624 -UN-15DEC88

RG, RG34710, 5591 -19-23NOV01-1/1

Do Not Modify Fuel System

CAUTION: Do not open high-pressure fuel system.

High-pressure fluid remaining in fuel lines can cause serious injury. Do not disconnect or attempt repair of fuel lines, sensors, or any other components between the high-pressure fuel pump and nozzles on engines with High Pressure Common Rail (HPCR) fuel system.

Only technicians familiar with this type of system can perform repairs. (See your John Deere dealer.)

IMPORTANT: Modification or alteration of the injection pump (arrow), the injection pump timing, or the fuel injectors in ways not recommended by the manufacturer will terminate the warranty obligation to the purchaser.

In addition, tampering with fuel system which alters emission-related equipment on engines may result in fines or other penalties, per EPA regulations or other local emission laws.

Do not attempt to service injection pump or fuel injectors yourself. Special training and special tools are required. (See your authorized servicing dealer or engine distributor.)



High-Pressure Fuel Lines

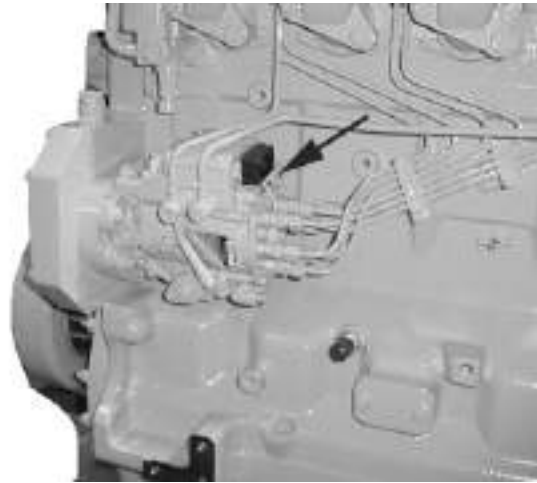

Fuel Injection Pump

TS1343 -UN-18MAR92

RG11953 -UN-26NOV01

RG, RG34710, 5592 -19-25MAR03-1/1

Adding Coolant

CAUTION: Explosive release of fluids from pressurized cooling system can cause serious burns.

Shut off engine. Only remove filler cap when cool enough to touch with bare hands. Slowly loosen cap to first stop to relieve pressure before removing completely.

IMPORTANT: Never pour cold liquid into a hot engine, as it may crack cylinder head or block. DO NOT operate engine without coolant for even a few minutes.

John Deere TY15161 Cooling System Sealer may be added to the radiator to stop leaks. DO NOT use any other stop-leak additives in the cooling system.

Air must be expelled from cooling system when coolant is added.

Coolant level should be maintained to the bottom of the radiator filler neck (A). If needed, as coolant as follows.

1. Loosen temperature sending unit fitting at rear of cylinder head or plug in side of thermostat housing to allow air to escape when filling system.

IMPORTANT: When adding coolant to the system, use the appropriate coolant solution. (See ENGINE COOLANT SPECIFICATIONS in Fuels, Lubricants, and Coolant Section for mixing of coolant ingredients before adding to cooling system.)

Do not overfill cooling system. A pressurized system needs space for heat expansion without overflowing at top of radiator.

2. Fill radiator (B) until coolant level touches bottom of radiator filler neck (A).



High-Pressure Fluids

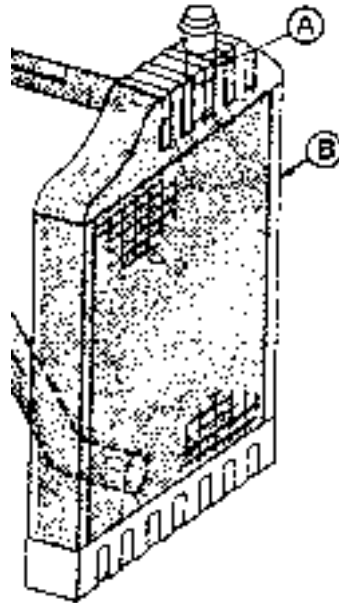

Radiator and Coolant

A—Radiator Filler Neck
B—Radiator

TSS281 -UN-23AUG88

RG13295 -UN-20NOV03

Continued on next page

OURGP11,0000222 -19-15OCT03-1/2

Service as Required

3. Tighten plugs and fittings when air has been expelled from system.
4. Run engine until it reaches operating temperature.

OURGP11,0000222 -19-15OCT03-2/2

Replacing Single Stage Air Cleaner

IMPORTANT: ALWAYS REPLACE air cleaner when air restriction indicator shows a vacuum of 625 mm (25 in.) H₂O, is torn, or visibly dirty.

NOTE: This procedure applies to John Deere single stage air cleaner kits. Refer to manufacturers' instructions for servicing air cleaners not supplied by John Deere.

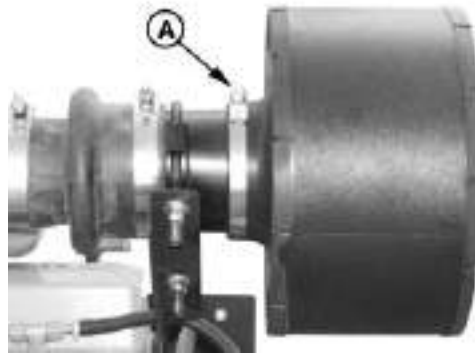

Single Stage Air Filter

1. If equipped, loosen body clamp.
2. Loosen clamp around outlet neck (A).
3. Remove air cleaner.
4. Install new filter so that overlap (B) of air cleaner outlet neck and engine intake pipe is to specification below.

Specification

Air Cleaner Neck to Engine Intake—Overlap..... 38 mm (1.5 in)

5. Tighten neck clamp (A) to specification below.

Specification

Air Cleaner Neck Clamp—Torque..... 6.8 N•m (60 lb-in.)

IMPORTANT: Do NOT overtighten body clamp. Overtightening may cause crushing of air cleaner body. Tighten body clamp only until snug.

6. If equipped, tighten body clamp until snug.

IMPORTANT: Whenever the air cleaner has been serviced or removed, ALWAYS fully depress the air restriction indicator reset button (if equipped) to assure accurate readings.

7. If equipped, fully depress air restriction indicator reset button and release to reset indicator.

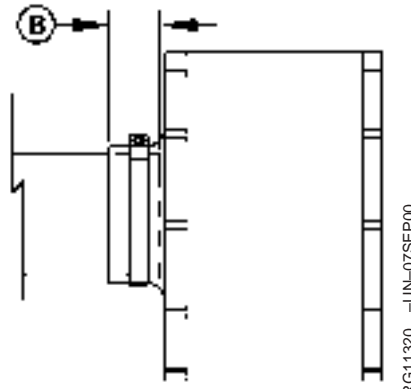

Installation of Single Stage Air Cleaner

A—Outlet Neck Clamp
B—Filter to Engine Overlap

RG11319A -UN-06SEP00

RG11320 -UN-07SEP00

Replacing Axial Seal Air Cleaner Filter Element

IMPORTANT: ALWAYS REPLACE primary air cleaner element when air restriction indicator (A) shows a vacuum of 625 mm (25 in.) H₂O, is torn, or visibly dirty.

NOTE: This procedure applies to John Deere 2-stage axial seal air cleaner kits. Refer to manufacturers' instructions for servicing air cleaners not supplied by John Deere.

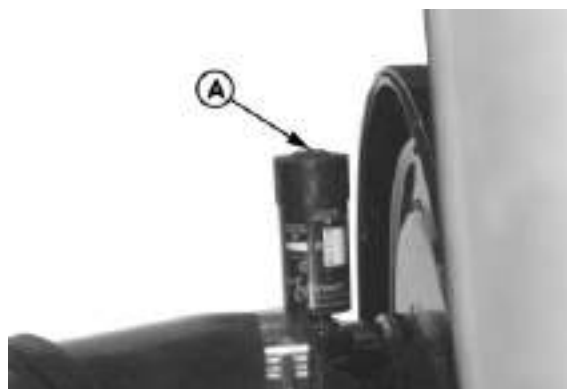

RG8719B -UN-03SEP99

Air restriction Indicator

Continued on next page

OURGP11,000013A -19-21NOV03-1/2

1. Remove wing nut and remove canister cover shown in small illustration inset.
2. Remove wing nut (A) and remove primary element (B) from canister.
3. Thoroughly clean all dirt from inside canister.

NOTE: Some engines may have a dust unloader valve (C) on the air cleaner. If equipped, squeeze valve tip to release any trapped dirt particles.

IMPORTANT: Remove secondary (safety) element (E) **ONLY** for replacement. **DO NOT** attempt to clean, wash, or reuse secondary element. Replacement of secondary element is usually necessary **ONLY** when primary element has a hole in it.

4. To replace secondary element, remove retaining nut (D) and secondary element (E). Immediately replace secondary element with new element to prevent dust from entering air intake system.
5. Install new primary element and tighten wing nut securely. Install cover assembly and tighten retaining wing nut securely.

IMPORTANT: Whenever the air cleaner has been serviced or had cover removed, **ALWAYS** fully depress the air restriction indicator reset button (if equipped) to assure accurate readings.

6. If equipped, fully depress air restriction indicator reset button and release to reset indicator.

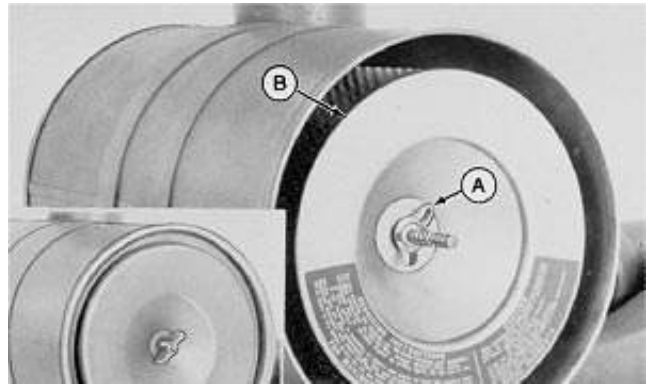

Wing Nut and Primary Element

RG4686 -UN-20DEC88

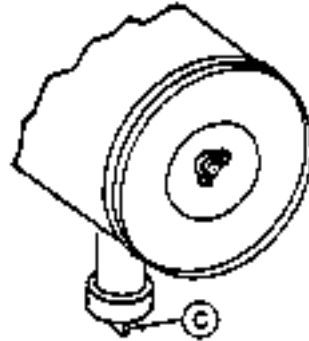

Dust Unloader Valve and Restriction Indicator

RG4687 -UN-20DEC88

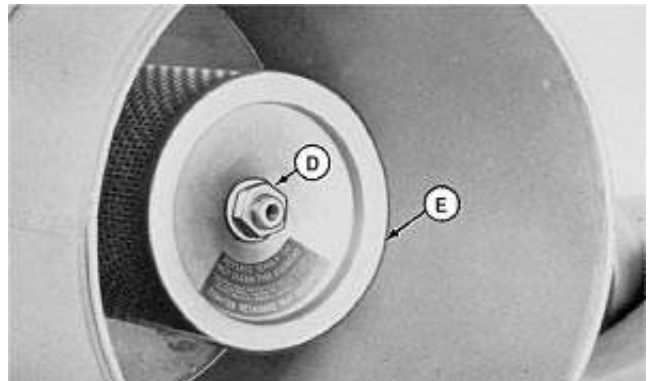

Retaining Nut and Secondary Element

RG11068 -UN-26JUN00

- A—Wing Nut
- B—Primary Element
- C—Dust Unloader Valve
- D—Retaining Nut
- E—Secondary Element

OURGP11,000013A -19-21NOV03-2/2

Replacing Radial Seal Air Cleaner Filter Element

IMPORTANT: ALWAYS REPLACE primary air cleaner element when air restriction indicator shows a vacuum of 625 mm (25 in.) H₂O, is torn, or visibly dirty.

NOTE: This procedure applies to John Deere 2-stage radial seal air cleaner kits. Refer to manufacturers' instructions for servicing air cleaners not supplied by John Deere.

1. Unlatch and remove dust cup/cover (A) of air cleaner.
2. Move end of filter (B) back and forth gently to break seal.
3. Pull filter (B) off outlet tube and out of housing.
4. Thoroughly clean all dirt from inside housing and from outlet bore.

IMPORTANT: Remove secondary (safety) element (C) ONLY for replacement. DO NOT attempt to clean, wash, or reuse secondary element. Replacement of secondary element is usually necessary ONLY when primary element has a hole in it.

5. To replace secondary element (C), pull filter element out gently. Immediately replace secondary element with new element to prevent dust from entering air intake system.
6. Install new primary filter element. Apply pressure by hand at outer rim of filter.

IMPORTANT: Do NOT use latches on cover to force filter into air cleaner. Using cover to force filter will damage cleaner housing.

7. Close housing with dust unloader valve aimed down and latch latches.



Dust Cup/Cover

RG11321A -UN-08SEP00



Primary Filter Element

RG11322A -UN-08SEP00



Secondary Filter Element

RG11327A -UN-08SEP00

A—Dust Cap/Cover
B—Primary Filter Element
C—Secondary Filter Element

Continued on next page

RG41165,000008B -19-06SEP00-1/2

IMPORTANT: Whenever the air cleaner has been serviced or cover has been removed, **ALWAYS** fully depress the air restriction indicator reset button (if equipped) to assure accurate readings.

8. If equipped, fully depress air restriction indicator reset button and release to reset indicator.

RG41165,000008B -19-06SEP00-2/2

Replacing Fan and Alternator Belts

Refer to CHECKING BELT TENSIONER SPRING TENSION AND BELT WEAR in Lubrication and Maintenance/500 Hour/12 Month Section for additional information on the belt tensioner.

1. Inspect belts for cracks, fraying, or stretched out areas. Replace if necessary.
2. To replace belt with automatic tensioner, release tension on belt using a breaker bar and socket on tension arm.

To replace belt with manual tensioner, release tension at belt tensioner (See MANUAL BELT TENSIONER ADJUSTMENT in Lubrication and Maintenance/500 Hour/12 Month Section.)

3. Remove poly-vee belt from pulleys and discard belt.

NOTE: While belt is removed, inspect pulleys and bearings. Rotate and feel for hard turning or any unusual sounds. If pulleys or bearings need replacement, see your John Deere dealer.

4. Install new belt, making sure belt is correctly seated in all pulley grooves. Refer to belt routing at right for your application.
5. Apply tension to belt with tensioner. Remove socket.
6. Install fan guard if removed.
7. Start engine and check belt alignment.

*Measured from crank centerline to fan drive center.

A—Alternator
 CSP—Crankshaft Pulley
 FC—Freon (A/C) Compressor
 FD—Fan Drive
 I—Idler Pulley
 T—Tensioner
 CP—Coolant Pump

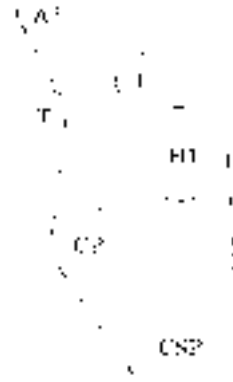

290 mm (11.4 in.) Fan Height and Lower*

RG11950 -UN-07NOV01

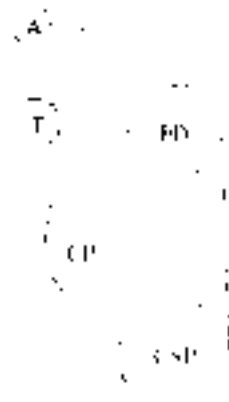

338 mm (13.3 in.) Fan Height and Higher Without Freon Compressor*

RG11951 -UN-07NOV01



402 mm (15.8 in.) Fan Height With Freon Compressor*

RG11952 -UN-07NOV01

Checking Fuses

NOTE: The instrument panels for later electronically controlled engines as described in Section 17 do not have this fuse.

Check fuse (A) located in fuse holder on face of instrument panel. If defective, replace with a 5-amp fuse.

A separate wiring harness fuse (10 amp) and a main system fuse (20 amp) are shown in the Wiring Diagrams in the Troubleshooting Section.

On 4045HF475 and 6068HF475 engines, a separate wiring harness for glow plugs (not shown) has fuse protection. To replace fuse, remove cap from holder on jumper cable and replace with a 50-amp fuse.

NOTE: On 4045DF/TF 270 engines, refer to supplier's instructions and diagrams for fuse location and type.

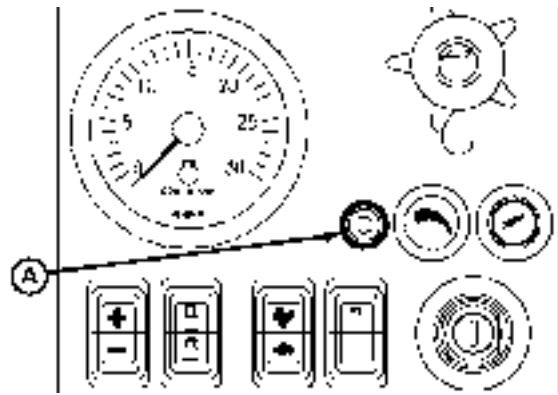

Early Engines with Electronic Instrument Panel

A—5 Amp Fuse

RG11938 -UN-06NOV01

OURGP11,000013C -19-21NOV03-1/1

Checking Air Compressors (If Equipped)

Air compressors are offered as options with John Deere OEM engines to provide compressed air to operate air-powered devices like vehicle air brakes.

Air compressors are engine-driven piston types. They are either air cooled or cooled with engine coolant. The compressors are lubricated with engine oil. The compressor runs continuously as gear or spline driven by the auxiliary drive of the engine but has "loaded" and "unloaded" operating modes. This is controlled by the vehicle's air system (refer to vehicle technical manual for complete air system checks and services).

See your John Deere engine distributor or servicing dealer for diagnostic and troubleshooting information. If diagnosis leads to an internal fault in the compressor, replace the complete compressor as a new or remanufactured unit.

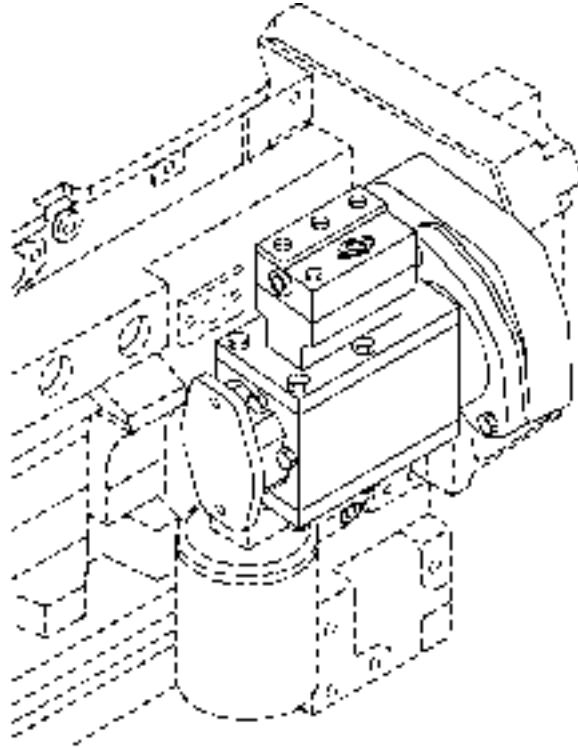

Air Compressor (Optional)

RG12836 -UN-27FEB03

OURGP12,00001E0 -19-26FEB03-1/1

Bleeding the Fuel System (Engines With Electronic Fuel Systems And Bosch VP44 Pump)



CAUTION: Escaping fluid under pressure can penetrate the skin causing serious injury. Relieve pressure before disconnecting fuel or other lines. Tighten all connections before applying pressure. Keep hands and body away from pinholes and nozzles which eject fluids under high pressure. Use a piece of cardboard or paper to search for leaks. Do not use your hand.

If ANY fluid is injected into the skin, it must be surgically removed within a few hours by a doctor familiar with this type injury or gangrene may result. Doctors unfamiliar with this type of injury may call the Deere & Company Medical Department in Moline, Illinois, or other knowledgeable medical source.



High-Pressure Fluids

X9811 -UN-23AUG88

Bleed the fuel system anytime the fuel system has been opened up. This includes:

- After fuel filter changes.
- After pump or nozzle replacement.
- Anytime fuel lines have been disconnected.
- After engine has run out of fuel.

This fuel system can only be bled by the electronic transfer pump or at the injection nozzles. **BLEEDING SHOULD NOT BE PERFORMED** at any location on the Bosch VP44 injection pump.

Continued on next page

QUOD002,000016A -19-25FEB03-1/3

Bleed Using Electronic Transfer Pump

The bleed is automatically performed by a small orifice (A) inside the final fuel filter base connected to the overflow valve on injection pump. The system allows air to escape continually through the fuel return line (B) when ignition is ON.

1. Ignition ON.
2. Allow 40 seconds for electronic transfer pump to complete priming.
3. If additional system bleeding is required, bleed the circuit by loosening fuel line connections at injection nozzles. See the next procedure, BLEED FUEL SYSTEM AT FUEL INJECTION NOZZLES.

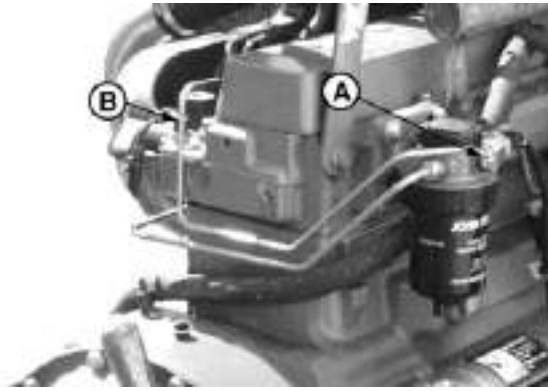

RG11719A -UN-20JUN01

Bleed Fuel System

A—Bleed Orifice in Final Fuel Filter Base
B—Fuel Return Line

OUOD002,000016A -19-25FEB03-2/3

Bleed Fuel System at Fuel Injection Nozzles

IMPORTANT: Always use a backup wrench when loosening or tightening fuel lines at nozzles and/or injection pump to avoid damage.

1. Using **two** open-end wrenches, loosen two fuel line connections at injection nozzles.
2. Crank engine over with starter motor for 15 seconds (but do not start engine) until fuel free from bubbles flows out of loosened connection. Retighten connection to specifications.



RG7725 -UN-08JAN97

Bleed At Fuel Injection Nozzles

Specification

Fuel Injection Nozzle Delivery
Line—Torque..... 27 N•m (20 lb-ft)

3. Repeat procedure for remaining injection nozzles (if necessary) until all air has been removed from fuel system.

OUOD002,000016A -19-25FEB03-3/3

Bleed the Fuel System (Engines with Electronic Fuel Systems and Stanadyne DE10 Pump)

CAUTION: Escaping fluid under pressure can penetrate the skin causing serious injury. Avoid hazards by relieving pressure before disconnecting hydraulic or other lines. Tighten all connections before applying pressure. Search for leaks with a piece of cardboard. Protect hands and body from high pressure fluids.



High Pressure Fluids

X9811 -UN-23AUG88

If an accident occurs, see a doctor immediately. Any fluid injected into the skin must be surgically removed within a few hours or gangrene may result. Doctors unfamiliar with this type of injury may call the Deere & Company Medical Department in Moline, Illinois, or other knowledgeable medical source.

Bleed the fuel system anytime the fuel system has been opened up. This includes:

- After fuel filter changes.
- After pump or nozzle replacement.
- Anytime fuel lines have been disconnected.
- After engine has run out of fuel.

The fuel system may be bled at one of several locations. Choose the best location for your engine/machine application.

Continued on next page

QUOD002,000016F -19-25FEB03-1/5

1. Loosen the air bleed vent screw (A) two full turns by hand on fuel filter base.

A—Bleed Vent Screw



RG11805 -UN-25OCT01

Final Fuel Filter Bleed Vent Screw

OUOD002,000016F -19-25FEB03-2/5

2. Operate fuel supply pump primer lever (B) or primer button on fuel filter base (if equipped).
3. Tighten bleed plug securely, continue operating primer until pumping action is not felt
4. Start engine and check for leaks.

If engine will not start, it may be necessary to bleed air from fuel system at fuel injection pump or injection nozzles as explained next.

B—Primer Lever



RG11806 -UN-25OCT01

Fuel Supply Pump Primer Lever

Continued on next page

OUOD002,000016F -19-25FEB03-3/5

At Fuel Injection Pump

1. Loosen fuel return line (A) at fuel injection pump.
2. Operate fuel supply pump primer lever or primer button on fuel filter base (if equipped).
3. As soon as fuel flow is free from air bubbles, tighten fuel return line to specifications. Primer lever is spring-loaded and will return to normal position.

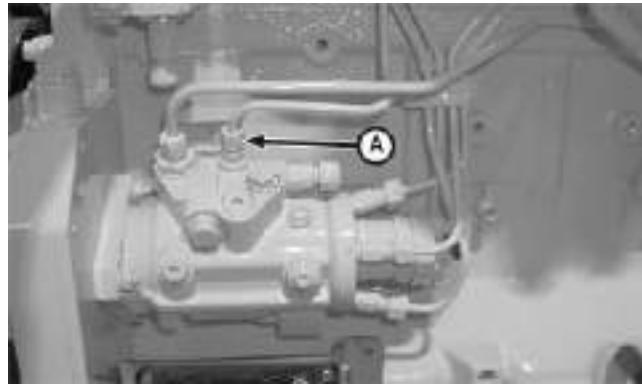

RG11807 -UN-25OCT01

Fuel Injection Pump Return Line

A—Fuel Return Line

Specification

Fuel Injection Pump Return
Line—Torque 27 N•m (20 lb-ft)

OUOD002,000016F -19-25FEB03-4/5

At Fuel Injection Nozzles

IMPORTANT: Always use a backup wrench when loosening or tightening fuel lines at nozzles and/or injection pump to avoid damage.

1. Using **two** open-end wrenches, loosen two fuel line connections at injection nozzles.
2. Crank engine over with starter motor for 15 seconds (but do not start engine) until fuel free from bubbles flows out of loosened connection. Retighten connection to specifications.



RG11808 -UN-25OCT01

Nozzle Fuel Pressure Line

Specification

Fuel Injection Nozzle Delivery
Lines—Torque 27 N•m (20 lb-ft)

3. Repeat procedure for remaining injection nozzles (if necessary) until all air has been removed from fuel system.

If engine still will not start, see your authorized servicing dealer or engine distributor.

OUOD002,000016F -19-25FEB03-5/5

Bleed the Fuel System (Engines with Electronic Fuel Systems and Denso High Pressure Common Rail) (4045HF475, 6068HF475)

! **CAUTION:** High-pressure fluid remaining in fuel lines can cause serious injury. Do not disconnect or attempt repair of fuel lines, sensors, or any other components between the high-pressure fuel pump and nozzles on engines with High Pressure Common Rail (HPCR) fuel system. Only technicians familiar with this type of system can perform repairs. (See your John Deere dealer.)

Escaping fluid under pressure can penetrate the skin causing serious injury. Avoid hazards by relieving pressure before disconnecting hydraulic or other lines. Tighten all connections before applying pressure. Search for leaks with a piece of cardboard. Protect hands and body from high pressure fluids.

If an accident occurs, see a doctor immediately. Any fluid injected into the skin must be surgically removed within a few hours or gangrene may result. Doctors unfamiliar with this type of injury may call the Deere & Company Medical Department in Moline, Illinois, or other knowledgeable medical source.

Any time the fuel system has been opened up for service (lines disconnected or filters removed), it will be necessary to bleed air from the system.



High-Pressure Fuel Lines



High Pressure Fluids

T51343 -UN-18MAR92

X9811 -UN-23AUG88

Continued on next page

OURGP11,000013E -19-21NOV03-1/3

NOTE: These are the 4-valve cylinder head 4.5 L and 6.8 L "475" model engines with Denso HP3 pumps and High Pressure Common Rail (HPCR) fuel systems (decal on rocker arm cover marked "16V" or "24V").

IMPORTANT: Four valve cylinder head engines are especially sensitive to fuel contamination. Do not crack any fuel lines to bleed the fuel system.

1. Loosen the air bleed vent screw (A) two full turns by hand on fuel filter base.



Final Fuel Filter Bleed Vent Screw

A—Bleed Vent Screw

RG12220 -JUN-24MAY02

OURGP11,000013E -19-21NOV03-2/3

2. Operate fuel supply pump primer lever (B), or primer button on fuel filter base (if equipped), until fuel flows out of bleed vent screw.
3. Tighten bleed vent screw securely. Continue operating primer until pumping action is not felt.
4. Start engine and check for leaks.

If engine will not start, repeat steps 1-4.

B—Primer Lever

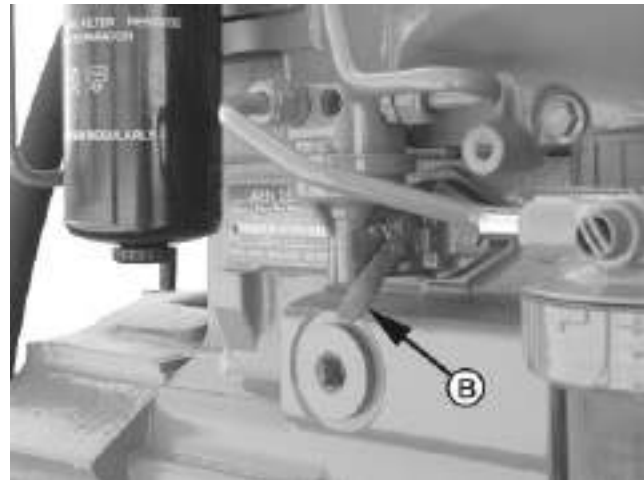

Fuel Supply Pump Primer Lever

RG12221 -JUN-24MAY02

OURGP11,000013E -19-21NOV03-3/3

Bleed the Fuel System (4045DF270, 4045TF270)



CAUTION: Escaping fluid under pressure can penetrate the skin causing serious injury. Relieve pressure before disconnecting fuel or other lines. Tighten all connections before applying pressure. Keep hands and body away from pinholes and nozzles which eject fluids under high pressure. Use a piece of cardboard or paper to search for leaks. Do not use your hand.

If ANY fluid is injected into the skin, it must be surgically removed within a few hours by a doctor familiar with this type injury or gangrene may result. Doctors unfamiliar with this type of injury may call the Deere & Company Medical Department in Moline, Illinois, or other knowledgeable medical source.

IMPORTANT: Do not operate the engine at high speeds or full loads just before bleeding the fuel system as this may cause fuel injection pump failure.

Bleed the fuel system anytime the fuel system has been opened up. This includes:

- After fuel filter changes.
- After pump or nozzle replacement.
- Anytime fuel lines have been disconnected.
- After engine has run out of fuel.



High-Pressure Fluids

X9811 -UN-23AUG88

Continued on next page

OURGP12,00001E9 -19-05MAR03-1/5

1. Loosen the air bleed vent screw (A) two full turns by hand on fuel filter base.

A—Vent Screw



RG7947 -UN-13NOV97

Air Bleed Vent Screw

OURGP12,00001E9 -19-05MAR03-2/5

2. Operate supply pump primer lever (B) until fuel flow is free from air bubbles.
3. Tighten bleed plug securely, continue operating hand primer until pumping action is not felt. Push hand primer inward (toward engine) as far as it will go.
4. Start engine and check for leaks.

If engine will not start, it may be necessary to bleed air from fuel system at fuel injection pump or injection nozzles as explained next.

B—Fuel Supply Pump Primer Lever

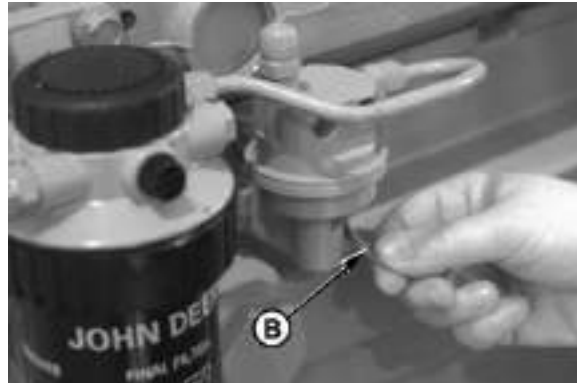

RG8013A -UN-15JAN99

Fuel Supply Pump Primer Lever

Continued on next page

OURGP12,00001E9 -19-05MAR03-3/5

At Fuel Injection Pump

1. Slightly loosen fuel return line connector (A) at fuel injection pump.
2. Operate fuel supply pump primer lever until fuel, without air bubbles, flows from fuel return line connection.
3. Tighten return line connector to 27 N•m (20 lb-ft).
4. Primer lever is spring-loaded and will return to normal position.

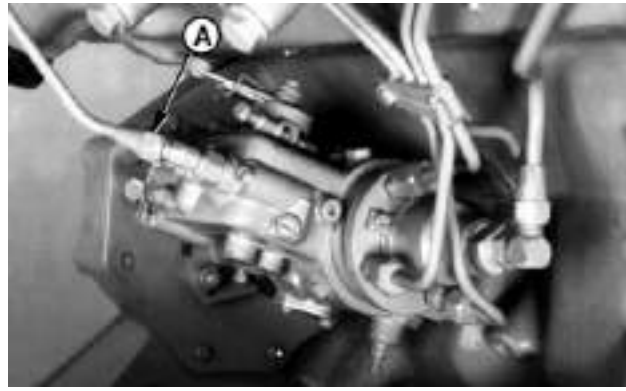

RG6264 -UN-03NOV97

Stanadyne Rotary Fuel Injection Pump

A—Fuel Return Line Connector

OURGP12,00001E9 -19-05MAR03-4/5

At Fuel Injection Nozzles

1. Move the engine speed control lever to half throttle position. On engines equipped with electronic fuel shut-off solenoid, energize solenoid.
2. Using **two** open-end wrenches, loosen fuel line connection at injection nozzle as shown.
3. Crank engine over with starter motor, (but do not start engine), until fuel free from bubbles flows out of loosened connection.
4. Retighten connection to 27 N•m (20 lb-ft).
5. Repeat procedure for remaining injection nozzles (if necessary) until all air has been removed from fuel system.



RG7725 -UN-08JAN97

Fuel Line Connection

If engine still will not start, see your authorized servicing dealer or engine distributor.

OURGP12,00001E9 -19-05MAR03-5/5

Troubleshooting

General Troubleshooting Information

Troubleshooting engine problems can be difficult. An engine wiring diagram is provided in this section to help isolate electrical problems on power units using John Deere wiring harness and instrument (gauge) panel.

Wiring diagrams are shown for the electronic instrument panel and harness offered for these engines.

Later in this section is a list of possible engine problems that may be encountered accompanied by possible causes and corrections. The illustrated diagrams and troubleshooting information are of a general nature; final design of the overall system for your engine application may be different. See your engine distributor or servicing dealer if you are in doubt.

A reliable program for troubleshooting engine problems should include the following basic diagnostic thought process:

- Know the engine and all related systems.
- Study the problem thoroughly.
- Relate the symptoms to your knowledge of engine and systems.
- Diagnose the problem starting with the easiest things first.
- Double-check before beginning the disassembly.
- Determine cause and make a thorough repair.
- After making repairs, operate the engine under normal conditions to verify that the problem and cause was corrected.

*NOTE: The engines covered in this manual have electronic control systems which send diagnostic trouble codes to signal problems (see **DIAGNOSTIC TROUBLE CODE PROCEDURE**, later in this section).*

RG, RG34710, 5605 -19-12NOV01-1/1

Precautions For Welding On Engines Equipped With Electronic Engine Control Unit (ECU)

IMPORTANT: ALWAYS disconnect Electronic Control Unit (ECU) connectors and engine control system-to-machine ground before welding on engine or machine. High currents or electro-static discharge in electronic components from welding may cause permanent damage.

1. Remove the ground connection for the engine control system-to-machine frame.
2. Disconnect the connectors from the ECU.
3. Connect the welder ground close to the welding point and be sure ECU or other electronic components are not in the ground path.

OUOD002,000016B -19-08OCT01-1/1

Engine Wiring Layout (Electronic Fuel System With Stanadyne DE10 Injection Pump)

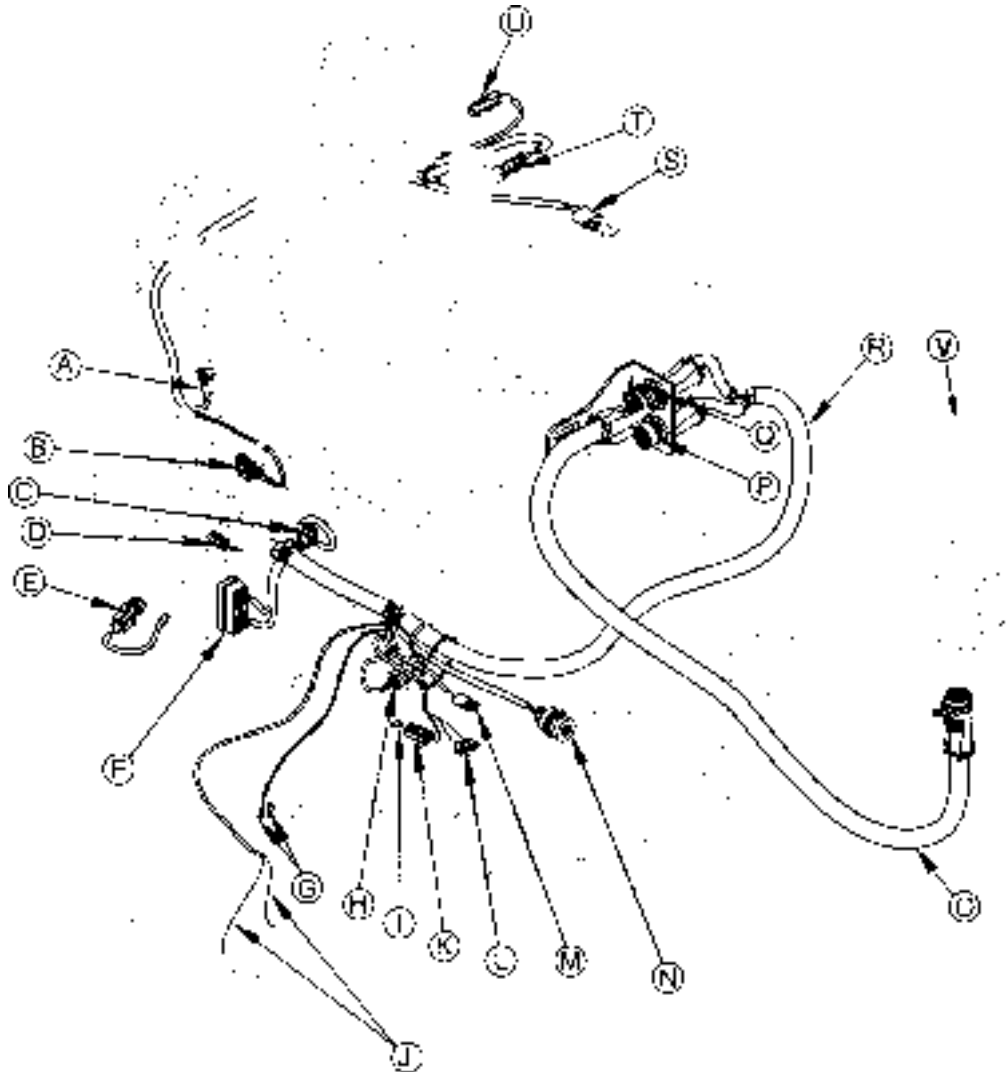

RG12201 -UN-24MAY02

A—Coolant Temperature Sensor Connector
 B—Fuel Temperature Sensor Connector
 C—Injection Pump Solenoid Connector
 D—SAE 1939 CAN Connector
 E—Crankshaft Position Sensor Connector
 F—ECU Connector

G—Starter Relay Connector
 H—Oil Pressure Sensor Connector
 I—Main System Fuse (10 amp) Connections
 J—Power and Ground Battery Connections
 K—Fuse Holder
 L—Transient Voltage Protection (TVP) Module Connector

M—Remote ON/ OFF Connector
 N—CAN Network Diagnostic Connector
 O—Instrument Panel Connector Harness
 P—23-pin Optional Feature Connector (Extended-feature ECU only)
 Q—21-pin Instrument Panel Connector

R—Engine Wiring Harness
 S—Fuel Heater Connector
 T—Manifold Air Temperature (MAT) Sensor Connector
 U—Alternator Ignition Connector
 V—Optional Instrument Panel (Earlier Version Shown)

OURGP11.0000276 -19-24NOV03-1/1

Engine Wiring Layout (Electronic Fuel System With Bosch VP44 Injection Pump)

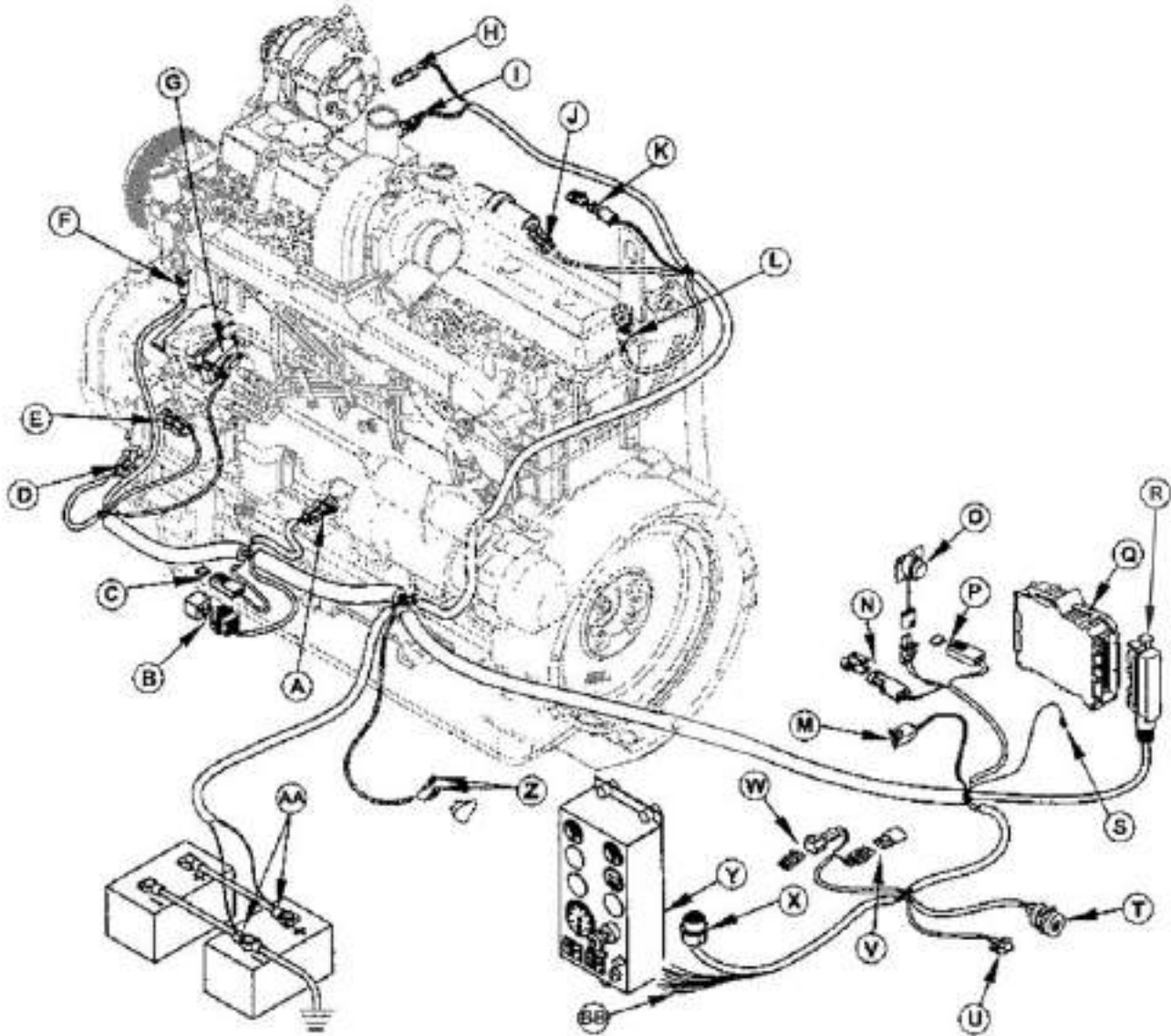

RG11939A -UN-05JUN02

- | | | | |
|------------------------------------|---|--|---|
| A—Oil Pressure Sensor | I—Manifold Air Temperature (MAT) Sensor | Q—Engine Control Unit (ECU) | W—Remote ON/OFF Connector |
| B—Fuel Pump Relay | J—Fuel Transfer Pump | R—ECU Connector | X—Instrument Panel Connector |
| C—Fuel Pump Relay Fuse | K—Fuel Heater | S—System Ground (ECU must also be grounded to frame) | Y—Optional Instrument Panel (Earlier Version Shown) |
| D—Crankshaft Position Sensor | L—Fuel Temperature Sensor | T—CAN Network Diagnostic Connector | Z—Starter Relay Connections |
| E—Fuel Injection Pump Event Sensor | M—Network CAN Connector Select Connector | U—Blink-Code Diagnostic Connector | AA—Power and Ground Battery Connections |
| F—Coolant Temperature Sensor | N—Isochronous Governor Select Connector | V—Secondary Analog Throttle Connector | BB—Optional Wire Extensions |
| G—Fuel Injection Pump Connector | O—Transient Voltage Protection (TVP) Module | | |
| H—Alternator Ignition Connector | P—Main System Fuse (20 Amp) | | |

OURGP11.0000277 -19-24NOV03-1/1

Engine Wiring Layout (Electronic Fuel System With Denso High Pressure Common Rail)(4045HF475,6068HF475)

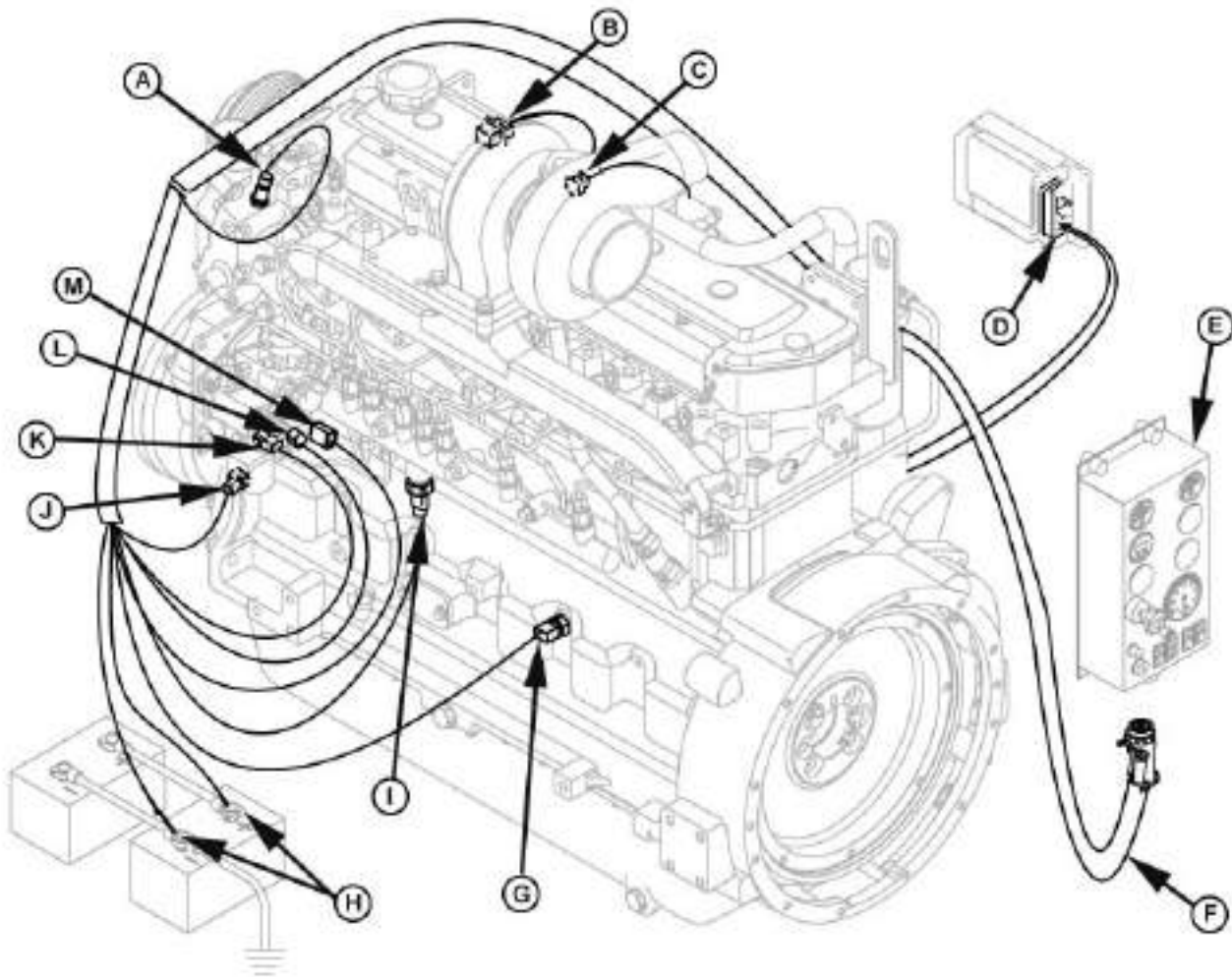

6068HF475 Engine Shown

- | | | | |
|---|---|--|-------------------------------|
| A—Engine Coolant Temperature (ECT) Sensor | D—(ECU) Connector | H—Power and Ground Battery Connections | K—Pump Position Sensor |
| B—Electronic Injector Connector | E—Optional Instrument Panel (Earlier Version Shown) | I—Fuel Rail Pressure Sensor | L—Pump Control Valve Solenoid |
| C—Manifold Air Temperature (MAT) Sensor | F—Engine Wiring Harness | J—Crankshaft Position Sensor | M—Fuel Temperature Sensor |
| | G—Engine Oil Pressure Sensor Connector | | |

RG12224 -UN-19JUN02

OURGP11,0000278 -19-24NOV03-1/1

Engine Wiring Diagram (With Earlier Electronic Instrument Panel)

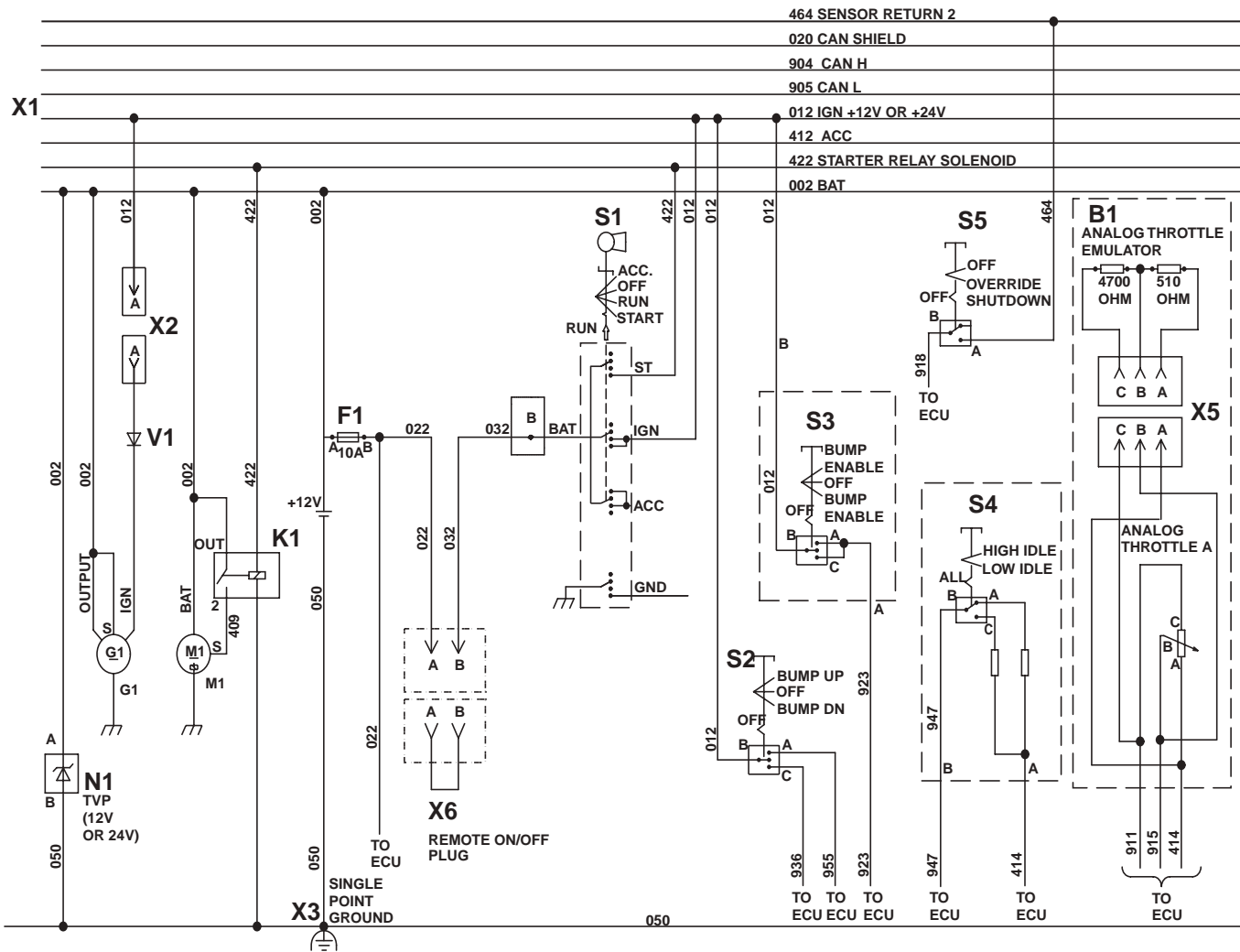

SE-1 ENGINE START COMPONENTS

SE-2 INSTRUMENT PANEL (CONTINUED NEXT PAGE)

- | | | | |
|--|--|---|---|
| <p>B1—Analog Throttle or Emulator
 E1—Back Light Regulator (24V) or Plug (12V)
 F1—Fuse (10 Amp) (for harness)
 F2—Fuse (5 Amp) (for instrument panel)
 G1—Alternator
 K1—Starter Relay
 M1—Starter Motor</p> | <p>N1—Transient Voltage Protector
 N2—Voltage Regulator (for 24V Operation)
 P1—Optional Gauge
 P2—Optional Gauge
 P3—Oil Pressure Gauge
 P4—Coolant Temperature Gauge
 P5—Tachometer Display
 P6—Hourmeter/Diagnostic Meter</p> | <p>S1—Ignition Key Switch
 S2—Speed Select Switch (Momentary)
 S3—Bump Enable Switch (Momentary)
 S4—High Low Speed Switch
 S5—Override Shutdown Switch (Momentary)
 S6—Dimmer Control or Jumper Plug</p> | <p>V1—Diode
 X1—Vehicle Harness Connector
 X2—Alternator Harness
 X3—Single Point Ground
 X4—CAN Terminator
 X5—Analog Throttle Connector
 X6—Remote On-Off Plug</p> |
|--|--|---|---|

RG11568 -19-24OCT01

Engine Wiring Diagram (With Earlier Electronic Instrument Panel)—Continued

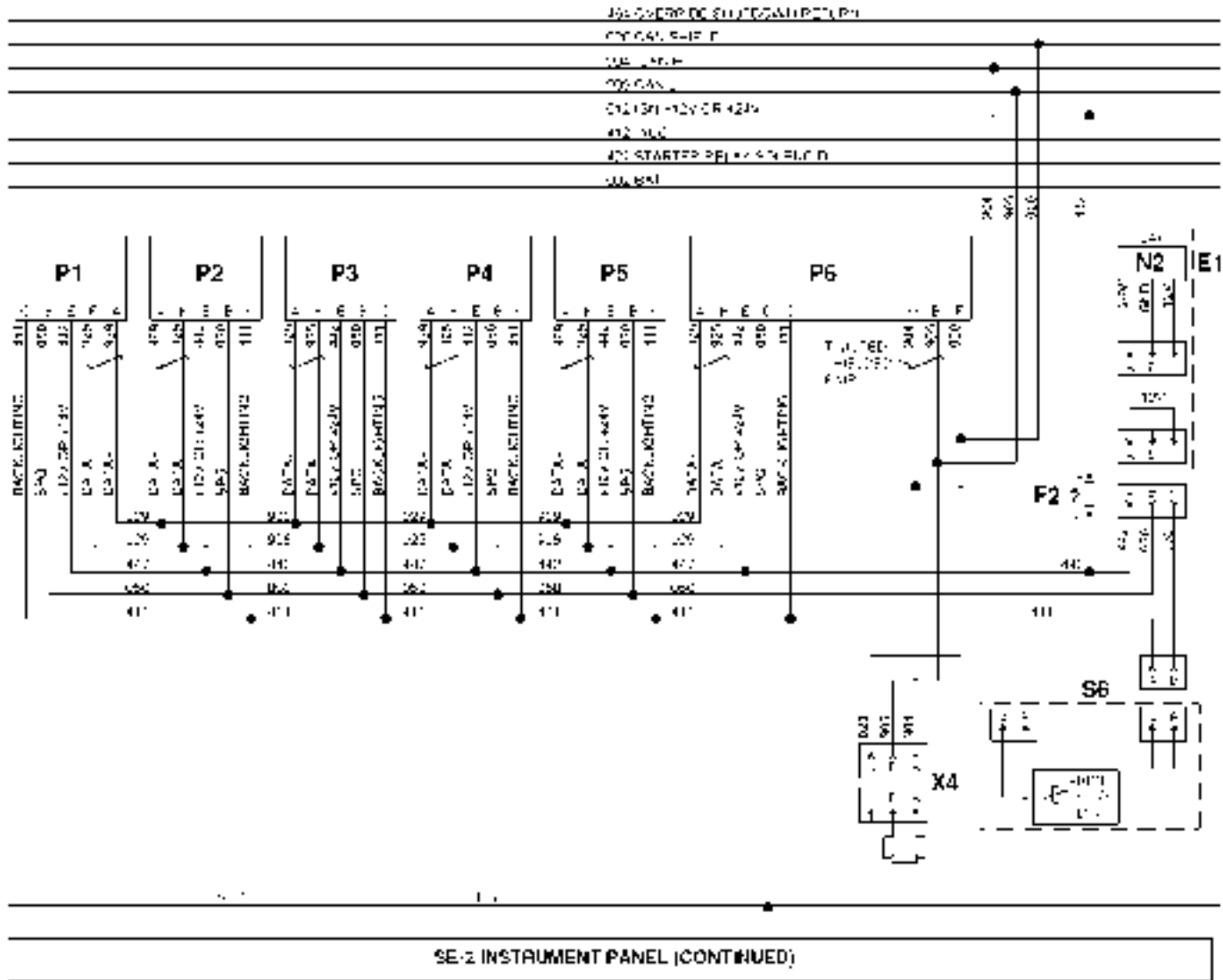

SEE INSTRUMENT PANEL (CONTINUED)

- | | | | |
|---|--|---|------------------------------|
| B1—Analog Throttle or Emulator | N1—Transient Voltage Protector | S1—Ignition Key Switch | V1—Diode |
| E1—Back Light Regulator (24V) or Plug (12V) | N2—Voltage Regulator (for 24V Operation) | S2—Speed Select Switch (Momentary) | X1—Vehicle Harness Connector |
| F1—Fuse (10 Amp) (for harness) | P1—Optional Gauge | S3—Bump Enable Switch (Momentary) | X2—Alternator Harness |
| F2—Fuse (5 Amp) (for instrument panel) | P2—Optional Gauge | S4—High Low Speed Switch | X3—Single Point Ground |
| G1—Alternator | P3—Oil Pressure Gauge | S5—Override Shutdown Switch (Momentary) | X4—CAN Terminator |
| K1—Starter Relay | P4—Coolant Temperature Gauge | S6—Dimmer Control or Jumper Plug | X5—Analog Throttle Connector |
| M1—Starter Motor | P5—Tachometer Display | | X6—Remote On-Off Plug |
| | P6—Hourmeter/Diagnostic Meter | | |

RG10040 -19-18MAY99

OURGP11.0000270 -19-24NOV03-1/1

Engine Wiring Diagram (With Later Full-Featured Electronic Instrument Panel)

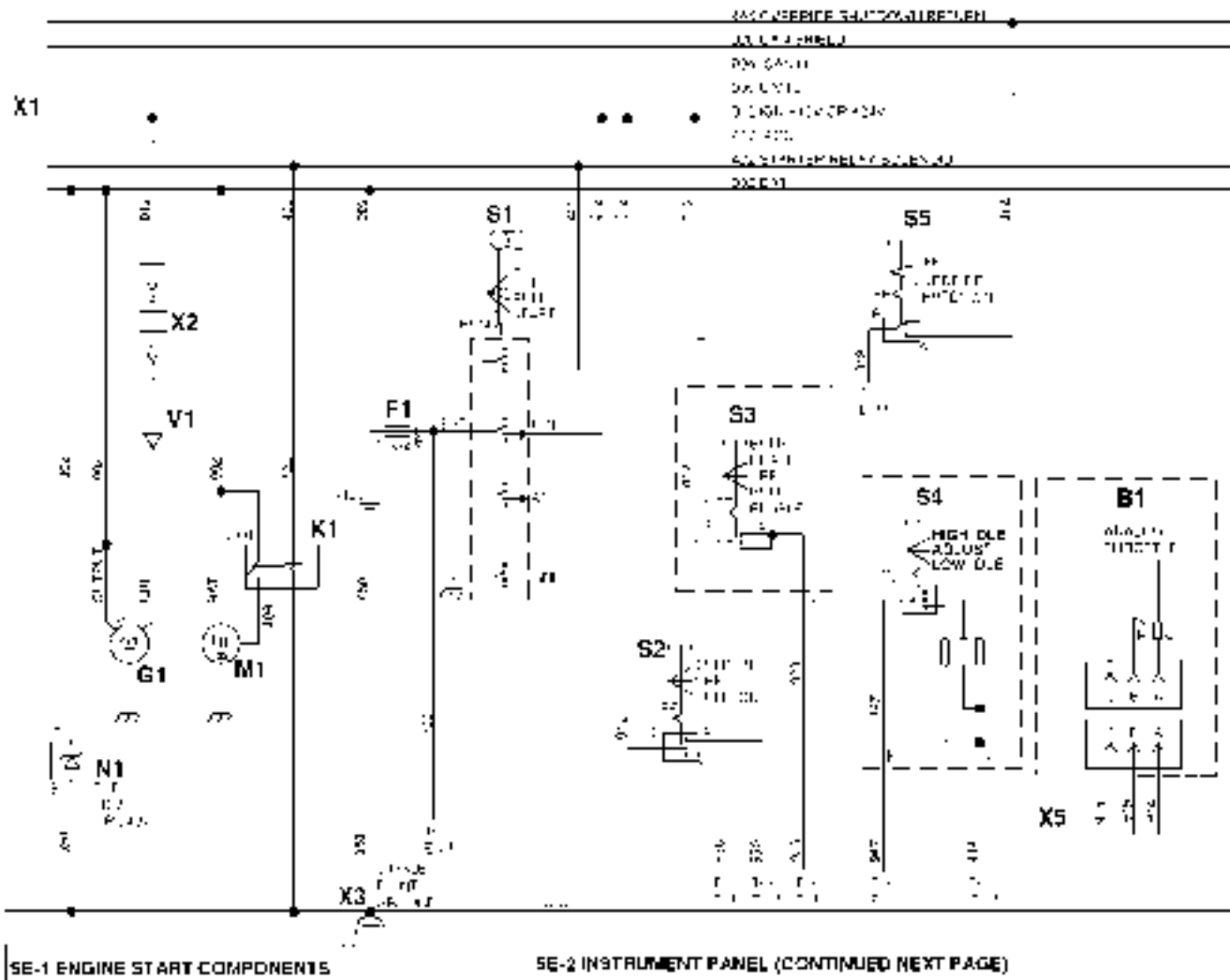

- B1—Analog Throttle
- F1—Fuse (30 Amp) (Harness)
- G1—Alternator
- K1—Starter Relay
- M1—Starter Motor
- N1—Transient Voltage Protector
- P1—Optional Gauge
- P2—Optional Gauge

- P3—Oil Pressure Gauge
- P4—Coolant Temperature Gauge
- P5—Tachometer Display
- P6—Hour Meter/Diagnostic Gauge
- S1—Ignition Key Switch
- S2—Speed Select Switch (Momentary)

- S3—Bump Enable Switch (Momentary)
- S4—High-Low Speed Select Switch
- S5—Override Shutdown Switch (Momentary)
- V1—Diode
- X1—Vehicle Harness Connector

- X2—Alternator Harness Connector
- X3—Single Point Ground
- X4—CAN Terminator
- X5—Analog Throttle Connector

RG13954 -UN-22JAN04

OURGP11,0000271 -19-24NOV03-1/1

**Engine Wiring Diagram (With Later Full-Featured Electronic Instrument Panel)—
Continued**

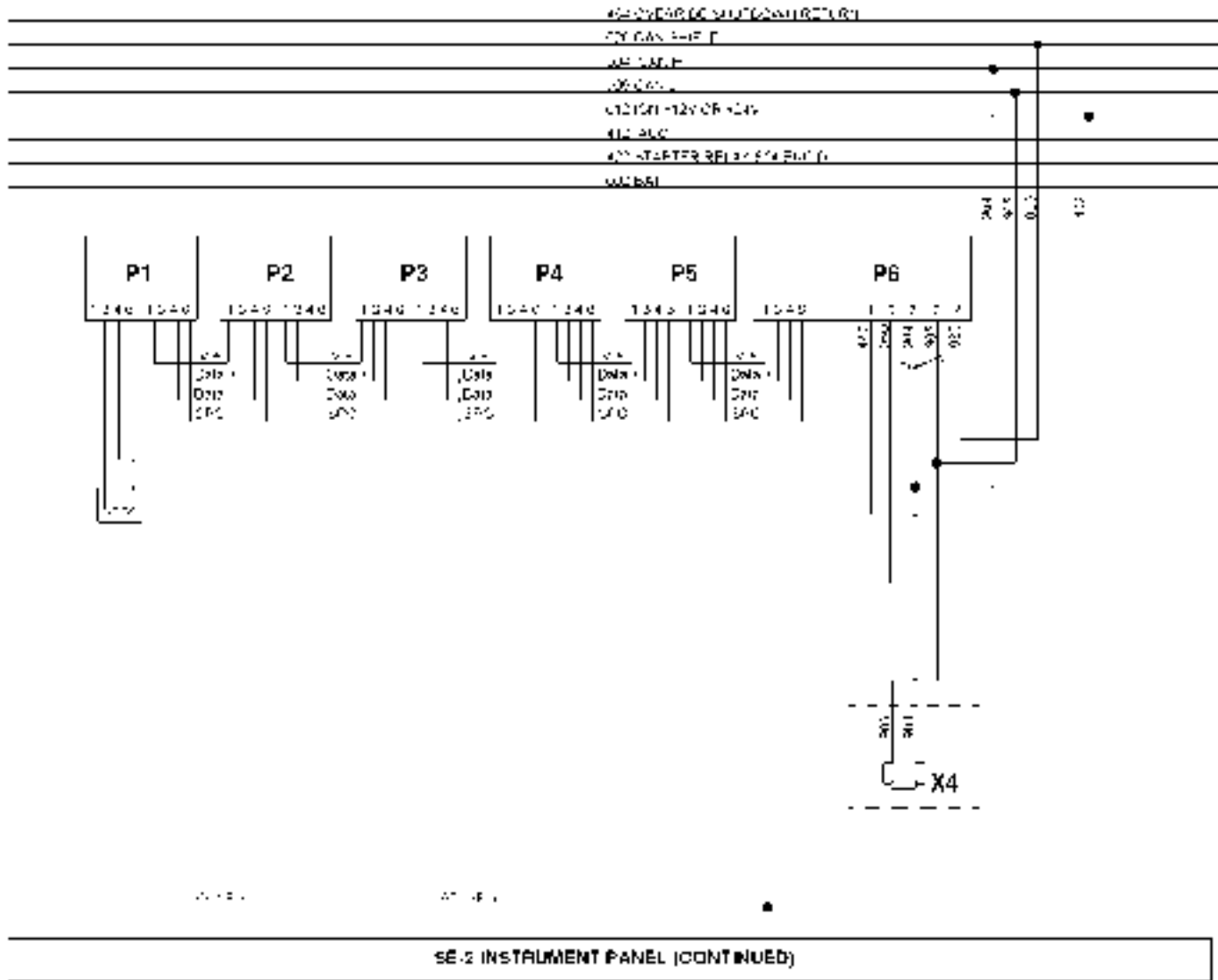

SE 2 INSTRUMENT PANEL (CONTINUED)

- | | | | |
|--------------------------------|------------------------------------|---|---------------------------------|
| B1—Analog Throttle | P3—Oil Pressure Gauge | S3—Bump Enable Switch (Momentary) | X2—Alternator Harness Connector |
| F1—Fuse (30 Amp) (Harness) | P4—Coolant Temperature Gauge | S4—High-Low Speed Select Switch | X3—Single Point Ground |
| G1—Alternator | P5—Tachometer Display | S5—Override Shutdown Switch (Momentary) | X4—CAN Terminator |
| K1—Starter Relay | P6—Hour Meter/Diagnostic Gauge | V1—Diode | X5—Analog Throttle Connector |
| M1—Starter Motor | S1—Ignition Key Switch | X1—Vehicle Harness Connector | |
| N1—Transient Voltage Protector | S2—Speed Select Switch (Momentary) | | |
| P1—Optional Gauge | | | |
| P2—Optional Gauge | | | |

RG13272 -UN-26JAN04

Engine Troubleshooting

Symptom	Problem	Solution
Engine cranks but will not start	Incorrect starting procedure.	Verify correct starting procedure.
	No fuel.	Check fuel in tank.
	Exhaust restricted.	Check and correct exhaust restriction.
	Fuel filter plugged or full of water.	Replace fuel filter or drain water from filter.
	Injection pump not getting fuel or air in fuel system.	Check fuel flow at supply pump or bleed fuel system.
	Faulty injection pump or nozzles.	Consult authorized diesel repair station for repair or replacement.

Continued on next page

RG, RG34710, 5608 -19-28MAR03-1/8

Symptom	Problem	Solution
Engine hard to start or will not start	Engine starting under load.	Disengage PTO.
	Improper starting procedure.	Review starting procedure.
	No fuel.	Check fuel tank.
	Air in fuel line.	Bleed fuel line.
	Cold weather.	Use cold weather starting aids.
	Slow starter speed.	See "Starter Cranks Slowly".
	Crankcase oil too heavy.	Use oil of proper viscosity.
	Improper type of fuel.	Consult fuel supplier; use proper type fuel for operating conditions.
	Water, dirt, or air in fuel system.	Drain, flush, fill, and bleed system.
	Clogged fuel filter.	Replace filter element.
	Dirty or faulty injection nozzles.	Have authorized servicing dealer or engine distributor check injectors.
	Defective glow plugs (Cold weather starting-4045HF475, 6068HF475)	Test glow plugs (See 2000 hour/24 month maintenance section)
	Electronic fuel system problem (if equipped)	See your John Deere distributor or servicing dealer.
Engine knocks	Low engine oil level.	Add oil to engine crankcase.
	Low coolant temperature.	Remove and check thermostat.
	Engine overheating.	See "Engine Overheats".
	Engine cold	Wrong or defective thermostat. Remove and check thermostat.

Continued on next page

RG, RG34710, 5608 -19-28MAR03-2/8

Symptom	Problem	Solution
Engine runs irregularly or stalls frequently	Low coolant temperature.	Remove and check thermostat.
	Clogged fuel filter.	Replace fuel filter element.
	Water, dirt, or air in fuel system.	Drain, flush, fill, and bleed system.
	Dirty or faulty injection nozzles.	Have authorized servicing dealer or engine distributor check injectors.
	Electronic fuel system problem	See your John Deere distributor or servicing dealer.
Below normal engine temperature	Defective thermostat.	Remove and check thermostat.
	Defective temperature gauge or sender.	Check gauge, sender, and connections.

Continued on next page

RG, RG34710, 5608 -19-28MAR03-3/8

Symptom	Problem	Solution
Lack of power	Engine overloaded.	Reduce load.
	Intake air restriction.	Service air cleaner.
	Clogged fuel filter.	Replace filter elements.
	Improper type of fuel.	Use proper fuel.
	Overheated engine.	See "Engine Overheats".
	Below normal engine temperature.	Remove and check thermostat.
	Improper valve clearance.	See your authorized servicing dealer or engine distributor.
	Dirty or faulty injection nozzles.	Have authorized servicing dealer or engine distributor check injectors.
	Injection pump out of time.	See your authorized servicing dealer or engine distributor.
	Electronic fuel system problem	See your John Deere distributor or servicing dealer.
	Turbocharger not functioning. (Turbocharger engines only.)	See your authorized servicing dealer or engine distributor.
	Leaking exhaust manifold gasket.	See your authorized servicing dealer or engine distributor.
	Defective aneroid control line.	See your authorized servicing dealer or engine distributor.
	Restricted fuel hose.	Clean or replace fuel hose.
Low oil pressure	Low fast idle speed.	See your authorized servicing dealer or engine distributor.
	Low oil level.	Add oil.
	Improper type of oil.	Drain, fill crankcase with oil of proper viscosity and quality.

Continued on next page

RG, RG34710, 5608 -19-28MAR03-4/8

Symptom	Problem	Solution
High oil consumption	Crankcase oil too light.	Use proper viscosity oil.
	Oil leaks.	Check for leaks in lines, gaskets, and drain plug.
	Restricted crankcase vent tube.	Clean vent tube.
	Defective turbocharger.	See your authorized servicing dealer or engine distributor.
Engine emits white smoke	Improper type of fuel.	Use proper fuel.
	Low engine temperature.	Warm up engine to normal operating temperature.
	Defective thermostat.	Remove and check thermostat.
	Defective injection nozzles.	See your authorized servicing dealer or engine distributor.
Engine emits black or gray exhaust smoke	Defective glow plugs (4045HF475, 6068HF475)	Test glow plugs (See 2000 hour/24 month maintenance section)
	Improper type of fuel.	Use proper fuel.
	Clogged or dirty air cleaner.	Service air cleaner.
	Engine overloaded.	Reduce load.
	Injection nozzles dirty.	See your authorized servicing dealer or engine distributor.
	Electronic fuel system problem	See your authorized servicing dealer or engine distributor.
	Turbocharger not functioning.	See your authorized servicing dealer or engine distributor.

Continued on next page

RG, RG34710, 5608 -19-28MAR03-5/8

Symptom	Problem	Solution
Engine overheats	Engine overloaded.	Reduce load.
	Low coolant level.	Fill radiator to proper level, check radiator and hoses for loose connections or leaks.
	Faulty radiator cap.	Have technician check.
	Stretched poly-vee belt or defective belt tensioner.	Check automatic belt tensioner and check belts for stretching. Replace as required.
	Low engine oil level.	Check oil level. Add oil as required.
	Cooling system needs flushing.	Flush cooling system.
	Defective thermostat.	Remove and check thermostat.
	Defective temperature gauge or sender.	Check coolant temperature with thermometer and replace, if necessary.
	Incorrect grade of fuel.	Use correct grade of fuel.
	High fuel consumption	Improper type of fuel.
Clogged or dirty air cleaner.		Service air cleaner.
Engine overloaded.		Reduce load.
Improper valve clearance.		See your authorized servicing dealer or engine distributor.
Injection nozzles dirty.		See your authorized servicing dealer or engine distributor.
Electronic fuel system problem		See your authorized servicing dealer or engine distributor.
Defective turbocharger.		See your authorized servicing dealer or engine distributor.
Low engine temperature.		Check thermostat.

Continued on next page

RG, RG34710, 5608 -19-28MAR03-6/8

Symptom	Problem	Solution
Undercharged electrical system	Excessive electrical load from added accessories.	Remove accessories or install higher output alternator.
	Excessive engine idling.	Increase engine rpm when heavy electrical load is used.
	Poor electrical connections on battery, ground strap, starter, or alternator.	Inspect and clean as necessary.
	Defective battery.	Test battery.
	Defective alternator.	Test charging system.
Battery uses too much water	Cracked battery case.	Check for moisture and replace as necessary.
	Defective battery.	Test battery.
	Battery charging rate too high.	Test charging system.
Batteries will not charge	Loose or corroded connections.	Clean and tighten connections.
	Sulfated or worn-out batteries.	See your authorized servicing dealer or engine distributor.
	Stretched poly-vee belt or defective belt tensioner.	Adjust belt tension or replace belts.
Starter will not crank	PTO engaged.	Disengage PTO.
	Loose or corroded connections.	Clean and tighten loose connections.
	Low battery output voltage.	See your authorized servicing dealer or engine distributor.
	Faulty start circuit relay.	See your authorized servicing dealer or engine distributor.
	Blown main system fuse (MDL-25)	Replace fuse.
Starter cranks slowly	Low battery output.	See your authorized servicing dealer or engine distributor.
	Crankcase oil too heavy.	Use proper viscosity oil.
	Loose or corroded connections.	Clean and tighten loose connections.

Continued on next page

RG, RG34710, 5608 -19-28MAR03-7/8

Troubleshooting

Symptom	Problem	Solution
Starter and hour meter functions; rest of electrical system does not function	Blown fuse on magnetic switch.	Replace fuse.
Entire electrical system does not function	Faulty battery connection.	Clean and tighten connections.
	Sulfated or worn-out batteries.	See your authorized servicing dealer or engine distributor.
	Blown main system fuse.	Replace fuse.

RG, RG34710, 5608 -19-28MAR03-8/8

Blink Code Method for Retrieving Diagnostic Trouble Codes (All Except Early VP44 Pump Engines)

NOTE: If engine has an electronic instrument panel with diagnostic gauge, refer to "Instrument Panel Method for Retrieving Diagnostic Trouble Codes" later in this section.

On OEM applications that have a Fault Lamp, the ECU has the ability to display DTCs using blinking sequence of the fault lamp. To retrieve DTCs from the ECU using the "blink code" method:

NOTE: The ECU blinks the codes in 2-digit codes only. See LISTING OF DIAGNOSTIC TROUBLE CODES (DTCS) later in this Group.

1. Turn the ignition switch "ON".
2. Press down Override Shutdown Switch (if equipped) for a few seconds.
3. The Fault Lamp will begin to flash a code number. For example, flash three times...short pause...flash two times...long pause. This example is code 32.
4. The ECU begins the flashing sequence by flashing a code 32, this indicates the start of blinking active codes. If there are any active DTCs, the ECU will flash it's 2-digit number. If there is more than one active DTC, the ECU will flash each code in numerical order. If there are no active DTCs, the Fault Lamp will flash a code 88.
5. Following the active codes, the Fault Lamp will flash a code 33. This indicates the start of blinking stored codes. If there are any stored DTCs, the Fault Lamp will flash its 2-digit number. If there is more than one stored DTC, the ECU will flash each code in numerical order. If there are no stored DTCs, the Fault Lamp will flash a code 88.
6. Once complete, this sequence will repeat.
7. When complete, turn ignition "OFF".

Continued on next page

OURGP12.00001EB -19-11MAR03-1/2

As an example, if an engine had an active DTC 18 and stored DTC 53, the flashing sequence would be: flash three times...short pause...flash two times...long pause...flash one time...short pause...flash eight times...long pause...flash three times...short pause...flash three times...long pause...flash five times...short pause...flash three times.

OURGP12.00001EB -19-11MAR03-2/2

Blink Code Method for Retrieving Diagnostic Trouble Codes (Early VP44 Pump Engines Only)

On OEM applications that have a Fault Lamp, the ECU has the ability to display Diagnostic Trouble Codes (DTCs) using blinking sequence of the fault lamp. To retrieve DTCs from the ECU using the "blink code" method:

NOTE: The ECU blinks the codes in 2-digit codes only. See LISTING OF DIAGNOSTIC TROUBLE CODES (DTCS) later in this Group.

1. Locate and uncap the 4-way METRI-PACK™ diagnostic blink code connector (A).
2. Using a short piece of wire, jump terminals A and B in the diagnostic blink code connector together.
3. Turn the ignition switch "ON".
4. The Fault Lamp will begin to flash a code number. For example, flash three times...short pause...flash two times...long pause. This example is code 32.
5. The ECU begins the flashing sequence by flashing a code 32, this indicates the start of blinking active codes. If there are any active DTCs, the ECU will flash it's 2-digit number. If there is more than one active DTC, the ECU will flash each code in numerical order. If there are no active DTCs, the Fault Lamp will flash a code 88.
6. Following the active codes, the Fault Lamp will flash a code 33, this indicates the start of blinking stored codes. If there are any stored DTCs, the Fault Lamp will flash its 2-digit number. If there is more than one stored DTC, the ECU will flash each code in numerical order. If there are no stored DTCs, the Fault Lamp will flash a code 88.
7. Once complete, this sequence will repeat.

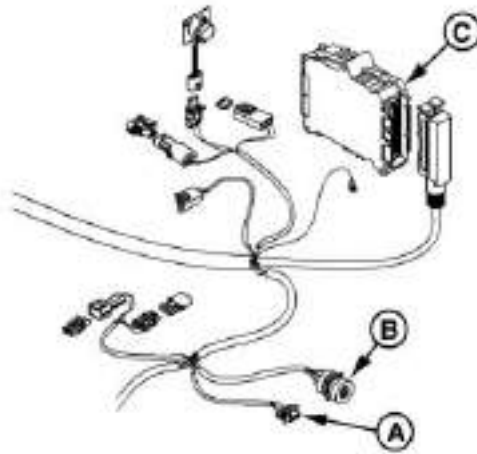

Diagnostic Blink Code Connector

A—Diagnostic Blink Code Connector
 B—Diagnostic Connector
 C—ECU

RG11754A -UN-13JUL01

8. When complete, turn ignition "OFF", remove jumper wire, and recap the diagnostic reader connector.

As an example, if an engine had an active DTC 18 and stored DTC 53, the flashing sequence would be: flash three times...short pause...flash two times...long pause...flash one time...short pause...flash eight times...long pause...flash three times...short pause...flash three times...long pause...flash five times...short pause...flash three times.

OURGP12.00001EA -19-11MAR03-2/2

Instrument Panel Method for Retrieving Diagnostic Trouble Codes

IMPORTANT: Care should be used during diagnostic procedures to avoid damaging the terminals of connectors, sensors, and actuators. Probes should not be poked into or around the terminals or damage will result. Probes should only be touched against the terminals to make measurements.

Diagnosis of the Deere electronic control system on engines with Deere electronic instrument panel (shown) should be performed as follows:

1. Make sure all engine mechanical and other systems not related to the electronic control system are operating properly.

NOTE: Liquid Crystal Display [LCD] will always default to last menu item. If an active Diagnostic Trouble Code (DTC) is present, display will alternately flash from the hour meter reading to DTC(s).

*The code number will appear on the first line and the words *SrvcCode* on the second line. Active DTC(s) can be viewed by selecting "SrvcCode" on the menu and pressing both touch switches at the same time. Pressing touch switches (B) and (C) scrolls through various engine parameters and diagnostic trouble codes.*

2. Read and record DTC(s) displayed on LCD of diagnostic gauge (A). For procedure to access diagnostic trouble codes, refer to "Using Diagnostic Gauge to Access Engine Information", earlier in this manual.

3. Go to the LISTING OF DIAGNOSTIC TROUBLE CODES (DTCs) later in this section, to interpret to the DTC(s) present.

4. Contact your nearest engine distributor or servicing dealer with a list of DTC(s) so that necessary repairs can be made.

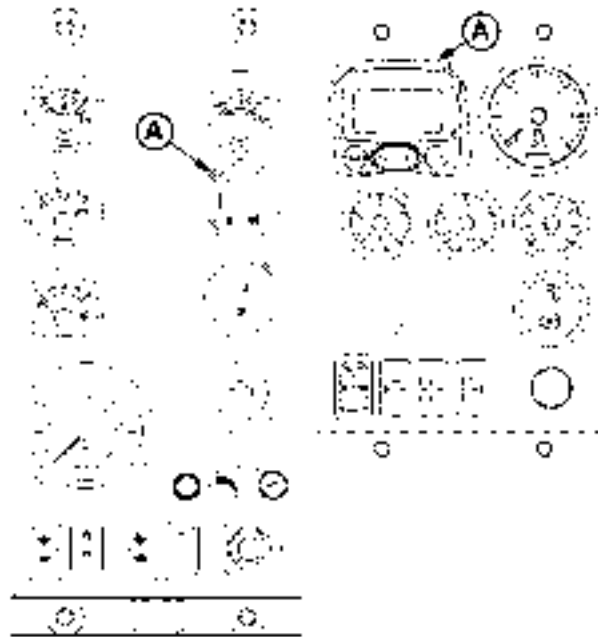

Trouble Code Display On Earlier Panel (Left) or Later Panel (Right)

A—Diagnostic Gauge

RG13287 -JUN-30OCT03

Displaying Of Diagnostic Trouble Codes (DTCs)

There are several different methods for displaying both stored and active DTCs from the ECU via a fault lamp or a diagnostic gauge on the electronic instrument panel.

2-DIGIT CODES

Some engines display Service Codes or DTCs as 2-digit codes read from a fault lamp which gives blink codes.

SPN/FMI CODES

Stored and active diagnostic trouble codes are output on the diagnostic gauge on the Deere electronic instrument panel according to the J1939 standard as a two-part code as shown on the tables on the following pages.

The first part is a six-digit Suspect Parameter Number (SPN) followed by a two-digit Failure Mode Identifier (FMI) code. In order to determine the exact failure, both parts (SPN and FMI) of the code are needed.

The SPN identifies the system or the component that has the failure; for example SPN 000110 indicates a failure in the engine coolant temperature circuit.

The FMI identifies the type of failure that has occurred; for example FMI 03 indicates value above normal. Combining SPN 000110 with FMI 03 yields engine coolant temperature input voltage too high, or the equivalent of 2-digit fault code 18.

If diagnosing an application that shows DTCs as SPNs and FMIs, using the following list, determine the equivalent 2-digit code and have your dealer use the diagnostic procedure in the component technical manual for that 2-digit code.

Always contact your servicing dealer for help in correcting diagnostic trouble codes which are displayed for your engine.

Listing of Diagnostic Trouble Codes (DTCs) (Engines With Electronic Fuel Systems And Stanadyne DE10 Pump)

NOTE: Not all of these codes are used on all OEM engine applications.

Third column below is for Blink Code retrieval method only.

Trouble Codes

DTC's Listing in Ascending SPN/FMI Codes

SPN	FMI	Blink Codes	Definition
000028	03	13	Throttle Voltage High
	04	14	Throttle Voltage Low
000029	03	15	Throttle Voltage High
	04	16	Throttle Voltage Low
	14	—	Throttle Voltage Out of Range
000084	31	—	Vehicle Speed Mismatch
000091	03	11	Throttle Voltage High
	04	12	Throttle Voltage Low
	07	—	Throttle Calibration Invalid
	10	—	Throttle Voltage Low
	13	—	Throttle Calibration Invalid
	14	—	Throttle Voltage Out of Range
000097	03	—	Water in Fuel Input Voltage High
	04	—	Water in Fuel Input Voltage Low
	16	—	Water in Fuel Detected
000100	01	65	Engine Oil Pressure Extremely Low
	03	23	Engine Oil Pressure Input Voltage High
	04	24	Engine Oil Pressure Input Voltage Low
	18	64	Engine Oil Pressure Moderately Low
000105	03	25	Manifold Air Temperature Input Voltage High
	04	26	Manifold Air Temperature Input Voltage Low
	16	66	Manifold Air Temperature Moderately High
000110	00	69	Engine Coolant Temperature High Most Severe
	03	18	Engine Coolant Temperature Input Voltage High
	04	19	Engine Coolant Temperature Input Voltage Low
	15	62	Engine Coolant Temperature High Least Severe
	16	63	Engine Coolant Temperature High Moderately Severe
000111	00	—	Loss of Coolant Temperature Extremely High
	03	—	Loss of Coolant Temperature Input Voltage High
	04	—	Loss of Coolant Temperature Input Voltage Low
000158	17	54	ECU Power Down Error
000160	02	—	Wheel Speed Input Noise
000174	03	37	Fuel Temperature Input Voltage High
	04	38	Fuel Temperature Input Voltage Low
	16	81	Fuel Temperature Moderately High
000189	00	—	Engine Speed Derate
000190	00	42	Engine Overspeed Extreme
	16	42	Engine Overspeed Moderate
000620	03	21	Sensor Supply Voltage High

Continued on next page

OURGP11.000013F -19-21NOV03-1/2

Troubleshooting

SPN	FMI	Blink Codes	Definition
	04	22	Sensor Supply Voltage Low
000627	04	—	ECU Unswitched Power Missing
000629	13	28	ECU Error
000637	02	39	Crank Position Input Noise
	10	39	Crank Position Input Pattern Error
000639	13	55	CAN Error
000729	03	—	Inlet Air Heater Signal High
	05	—	Inlet Air Heater Signal Low
000898	09	—	Vehicle Speed Invalid/Missing
000970	31	83	Auxiliary Engine Shutdown Switch Active
000971	31	84	External Engine Derate Switch Active
001069	09	—	Tire Speed Invalid
	31	—	Tire Speed Error
001076	00	71	Pump Control Valve Closure Too Long
	01	72	Pump Control Valve Closure Too Short
	03	77	Pump Solenoid Current High
	05	73	Pump Solenoid Circuit Open
	06	74	Pump Solenoid Circuit Severely Shorted
	07	75	Pump Control Valve Closure Not Detected
	10	76	Pump Solenoid Circuit Moderately Shorted
	13	—	Pump Current Decay Time Invalid
001079	03	—	Sensor Supply Voltage High
	04	—	Sensor Supply Voltage Low
001109	31	—	Engine Shutdown Warning
001110	31	82	Engine Shutdown
001568	04	—	Torque Curve Select Voltage Low
001569	31	68	Fuel Derate
002000	06	79	Internal ECU Failure
	13	78	Security Violation
N/A	N/A	32	When reading blink codes, signifies the start of active codes.
N/A	N/A	33	When reading blink codes, signifies the start of previously active codes.
N/A	N/A	88	When reading blink codes, signifies that no fault codes are in the buffer.

OURGP11,000013F -19-21NOV03-2/2

Listing of Diagnostic Trouble Codes (DTCs) (Engines With Electronic Fuel Systems And Bosch VP44 Pump)

NOTE: Not all of these codes are used on all OEM engine applications

Third column below is for for Blink Code retrieval method only.

Trouble Codes

DTC's Listing in Ascending SPN/FMI Codes

SPN	FMI	Blink Code	Definition
000028	03	13	Throttle Volts High
	04	14	Throttle Volts Low
000029	03	15	Throttle Volts High
	04	16	Throttle Volts Low
000084	02	91	Vehicle Speed Mismatch
000091	03	11	Throttle Volts High
	04	12	Throttle Volts Low
	09	—	Throttle Invalid
000094	01	58	Fuel Supply Pressure Extremely Low
	03	27	Fuel Supply Pressure Input Voltage High
	04	28	Fuel Supply Pressure Input Voltage Low
	18	57	Fuel Supply Pressure Moderately Low
000097	00	—	Water in Fuel Continuously Detected
	16	—	Water in Fuel Detected
000100	01	75	Engine Oil Pressure Extremely Low
	03	23	Engine Oil Pressure Input Voltage High
	04	24	Engine Oil Pressure Input Voltage Low
	18	74	Engine Oil Pressure Moderately Low
000105	00	56	Manifold Air Temperature Extremely High
	03	25	Manifold Air Temperature Input Voltage High
	04	26	Manifold Air Temperature Input Voltage Low
	16	55	Manifold Air Temperature Moderately High
000107	00	—	Air Filter Differential Pressure
000110	00	63	Engine Coolant Temperature Extremely High
	03	18	Engine Coolant Temperature Input Voltage High
	04	19	Engine Coolant Temperature Input Voltage Low
	15	61	Engine Coolant Temperature High Least Severe
	16	62	Engine Coolant Temperature Moderately High
000111	01	64	Engine Coolant Level Low
000158	17	54	ECU Power Down Error
000174	00	67	Fuel Temperature High Most Severe
	15	53	Fuel Temperature High Least Severe
	16	71	Fuel Temperature High Moderately Severe
	31	98	Fuel Temperature Sensor Faulty
000189	00	—	Engine Speed Derate
	31	48	Engine Speed Derate
000190	00	42	Engine Overspeed Extreme
	16	42	Engine Overspeed Moderate
000620	03	21	Sensor Supply Voltage High

Continued on next page

OURGP11.0000140 -19-21NOV03-1/2

Troubleshooting

SPN	FMI	Blink Code	Definition
	04	22	Sensor Supply Voltage Low
000627	04	76	ECU Unswitched Power Missing
000629	13	34	ECU Error
	19	34	ECU to Pump Communication Error
000632	02	37	Fuel Shutoff Error
	05	86	Fuel Shutoff Non-Functional
000636	02	44	Pump Position Input Noise
	08	43	Pump Position Input Missing
	10	44	Pump Position Input Pattern Error
000637	02	39	Crank Position Input Noise
	08	38	Crank Position Input Missing
	10	39	Crank Position Input Pattern Error
000729	03	—	Inlet Air Heater Signal High
	05	—	Inlet Air Heater Signal Low
000810	02	92	Calculated Vehicle Speed Input Noise
000898	09	77	Vehicle Speed Invalid/Missing
000970	02	—	Auxiliary Engine Shutdown Switch Signal Invalid
	31	83	Auxiliary Engine Shutdown Switch Active
000971	31	84	External Engine Derate Switch Active
001069	02	93	Tire Size Error
001076	02	66	Pump Detected Defect
001077	07	35	Attempting to Fuel Without Command
	11	68	Pump Supply Voltage Out of Range
	12	97	Pump Self Test Error
	19	96	Pump Detected Communication Error
	31	36	Pump Initiated Engine Protection
001078	07	95	ECU/Pump Timing Moderately Out of Sync
	11	87	ECU/Pump Speed Out of Sync
	31	94	ECU/Pump Timing Extremely Out of Sync
001079	03	21	Sensor Supply 1 Voltage High
	04	22	Sensor Supply 1 Voltage Low
001080	03	51	Sensor Supply 2 Voltage High
	04	52	Sensor Supply 2 Voltage Low
001109	31	—	Engine Shutdown Warning
001110	31	82	Engine Shutdown
001485	02	89	Pump Power Relay Fault
001569	31	47	Fuel Derate
002000	13	—	Security Violation

OURGP11,0000140 -19-21NOV03-2/2

Listing of Diagnostic Trouble Codes (DTCs) (Engines With Electronic Fuel Systems And Denso High Pressure Common Rail) (“475” Engines)

NOTE: Not all of these codes are used on all OEM engine applications

Third column below is for Blink Code retrieval method only.

Trouble Codes

DTC's Listing in Ascending SPN/FMI Codes

SPN	FMI	Blink Code	Description
000028	03	15	Analog Throttle (B) Voltage High
	04	—	Analog Throttle (B) Voltage Low
000029	03	13	Analog Throttle (A) Voltage High
	04	—	Analog Throttle (A) Voltage Low
000084	31	—	Vehicle Speed Mismatch
000091	03	11	Multi-state Throttle Voltage High
	04	12	Multi-state Throttle Voltage Low
	09	—	Throttle Invalid
000094	03	27	Fuel Rail Pressure Input Voltage High
	04	28	Fuel Rail Pressure Input Voltage Low
	10	86	Fuel Rail Pressure Loss Detected
	13	—	Fuel Rail Pressure Higher Than Expected
	17	85	Fuel Rail Pressure Not Developed
000097	00	—	Water in Fuel Continuously Detected
	03	—	Water in Fuel Signal Voltage High
	04	—	Water in Fuel Signal Voltage Low
	16	—	Water in Fuel Detected
000100	01	75	Engine Oil Pressure Extremely Low
	03	23	Engine Oil Pressure Input Voltage High
	04	24	Engine Oil Pressure Input Voltage Low
	18	74	Engine Oil Pressure Moderately Low
000105	00	—	Manifold Air Temperature Extremely High
	03	25	Manifold Air Temperature Input Voltage High
	04	26	Manifold Air Temperature Input Voltage Low
	16	55	Manifold Air Temperature Moderately High
000107	00	—	Air Filter Differential Pressure
000110	00	63	Engine Coolant Temperature High Most Severe
	03	18	Engine Coolant Temperature Input Voltage High
	04	19	Engine Coolant Temperature Input Voltage Low
	15	61	Engine Coolant Temperature High Least Severe
	16	62	Engine Coolant Temperature High Moderately Severe
000111	01	64	Engine Coolant Level Low
000158	17	54	ECU Power Down Error
000160	02	—	Wheel Speed Input Noise
000174	00	—	Fuel Temperature High Most Severe
	03	37	Fuel Temperature Input Voltage High
	04	38	Fuel Temperature Input Voltage Low

Continued on next page

OURGP11.0000141 -19-21NOV03-1/3

Troubleshooting

SPN	FMI	Blink Code	Description
	16	71	Fuel Temperature High Moderately Severe
000189	00	—	Engine Speed Derate
000190	00	42	Engine Overspeed Extreme
	16	42	Engine Overspeed Moderate
000611	03	98	Electronic Injector Wiring Shorted to Power Source
	04	99	Electronic Injector Wiring Shorted to Ground
000620	03	21	Sensor Supply 2 Voltage High
	04	22	Sensor Supply 2 Voltage Low
000627	01	97	Electronic Injector Supply Voltage Problem
000629	13	—	ECU Error
000636	02	44	Pump Position Sensor Input Noise
	08	43	Pump Position Sensor Input Missing
	10	44	Pump Position Sensor Input Pattern Error
000637	02	39	Crank Position Input Noise
	07	45	Crank/Pump Timing Moderately Out of Sync
	08	41	Crank Position Input Missing
	10	39	Crank Position Input Pattern Error
000639	13	—	CAN Bus Error
000651	05	31	Cylinder #1 EI Circuit Open
	06	91	Cylinder #1 EI Circuit Shorted
	07	65	Cylinder #1 EI Delivery Failure
000652	05	29	Cylinder #2 EI Circuit Open
	06	92	Cylinder #2 EI Circuit Shorted
	07	66	Cylinder #2 EI Delivery Failure
000653	05	17	Cylinder #3 EI Circuit Open
	06	93	Cylinder #3 EI Circuit Shorted
	07	59	Cylinder #3 EI Delivery Failure
000654	05	34	Cylinder #4 EI Circuit Open
	06	94	Cylinder #4 EI Circuit Shorted
	07	67	Cylinder #4 EI Delivery Failure
000655	05	35	Cylinder #5 EI Circuit Open
	06	95	Cylinder #5 EI Circuit Shorted
	07	56	Cylinder #5 EI Delivery Failure
000656	05	36	Cylinder #6 EI Circuit Open
	06	96	Cylinder #6 EI Circuit Shorted
	07	68	Cylinder #6 EI Delivery Failure
000676	03	—	Glow Plug Relay Voltage High
	05	—	Glow Plug Relay Voltage Low
000898	09	—	Vehicle Speed or Torque Message Invalid
000970	31	83	Engine Shutdown - Auxiliary Request
000971	31	84	External Fuel Derate Switch Active
001069	09	—	Tire Size Invalid
	31	—	Tire Size Error
001079	03	51	Sensor Supply 1 Voltage High
	04	52	Sensor Supply 1 Voltage Low
001080	03	49	Fuel Rail Pressure Sensor Supply Voltage High
	04	48	Fuel Rail Pressure Sensor Supply Voltage Low
001109	31	—	Engine Protection Shutdown Warning
001110	31	82	Engine Protection Shutdown
001347	03	79	Pump Return Shorted High
	05	77	Pump Control Valve Error
	07	78	Fuel Rail Pressure Control Error
001568	02	—	Torque Curve Selection Invalid
001569	31	—	Fuel Derate

Continued on next page

OURGP11.0000141 -19-21NOV03-2/3

SPN	FMI	Blink Code	Description
002000	13	—	Security Violation
N/A	N/A	32	When reading blink codes, signifies the start of active codes.
N/A	N/A	33	When reading blink codes, signifies the start of stored codes.
N/A	N/A	88	When reading blink codes, signifies that no fault codes are in the buffer.

OURGP11,0000141 -19-21NOV03-3/3

Error Codes Displayed (With Early Electronic Panels)

NOTE: The Diagnostic Gauge on the earlier electronic instrument panel can have communication problems that result in Error Codes being shown on its LCD display window. The following Error Codes all indicate that there is a Diagnostic Gauge communication error with the ECU. Contact your servicing dealer for help in correcting these codes:

EE—Error	XXXXX—EP
	No Data
ACP—Err	XXXXX—BO
No Addr	No Data
ACP—Err	XXXXX—BR
BUS—EP	No Data

NOTE: Later instrument panels will display text for communication faults, such as "CAN BUS FAILURE".

OURGP11,0000152 -19-06JAN04-1/1

Intermittent Fault Diagnostics (With Electronic Controls)

Intermittent faults are problems that periodically “go away”. A problem such as a terminal that intermittently doesn’t make contact can cause an intermittent fault. Other intermittent may be set only under certain operating conditions such as heavy load, extended idle, etc. When diagnosing intermittent faults, take special note of the condition of wiring and connectors, since a high percentage of intermittent problems originate here. Check for loose, dirty or disconnected connectors. Inspect the wiring routing, looking for possible shorts caused by contact with external parts (for example, rubbing against sharp sheet metal edges). Inspect the connector vicinity, looking for wires that have pulled out of connectors, poorly positioned terminals, damaged connectors and corroded or damaged splices and terminals. Look for broken wires, damaged splices, and wire-to-wire shorts. Use good judgement if component replacement is thought to be required.

NOTE: The engine control unit (ECU) is the component **LEAST** likely to fail.

Suggestions for diagnosing intermittent faults:

- If the problem is intermittent, try to reproduce the operating conditions that were present when the diagnostic trouble code (DTC) set.
- If a faulty connection or wire is suspected to be the cause of the intermittent problem: clear DTCs, then check the connection or wire by wiggling it while watching the diagnostic gauge to see if the fault resets.

Possible causes of intermittent faults:

- Faulty connection between sensor or actuator harness.
- Faulty contact between terminals in connector.
- Faulty terminal/wire connection.
- Electromagnetic interference (EMI) from an improperly installed 2-way radio, etc., can cause faulty signals to be sent to the ECU.

NOTE: Refer to wiring diagrams earlier in this section as a guide to connection and wiring.

OUOD007,0000036 -19-26FEB03-1/1

Displaying Diagnostic Gauge Software (Later Engines)

NOTE: The following steps can be used to display the software version of the diagnostic gauge if needed by your dealer for troubleshooting. This is a read only function.

1. Starting at the single or four engine parameter display, press the "Menu" key.

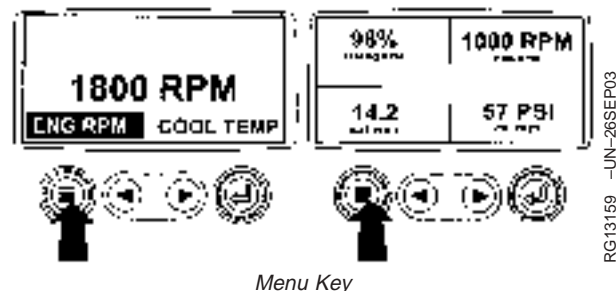

Menu Key

Continued on next page

OURGP11,000012B -19-30OCT03-1/4

2. The main menu will be displayed. Use the "Arrow" key to scroll through the menu until "Utilities" is highlighted.



Select Utilities

RG13234 -UN-22OCT03

OURGP11,000012B -19-30OCT03-2/4

3. Once "Utilities" is highlighted, press "Enter" to activate the utilities function.



Select Utilities

RG13237 -UN-22OCT03

OURGP11,000012B -19-30OCT03-3/4

4. Scroll to the "Software Version". Press "Enter" to view the software version. Press the menu button twice to return to the main menu.



Software Version

RG13236 -UN-13OCT03

OURGP11,000012B -19-30OCT03-4/4

Storage

Engine Storage Guidelines

1. John Deere engines can be stored outside for up to three (3) months with no long term preparation IF COVERED BY WATERPROOF COVERING.
2. John Deere engines can be stored in a standard overseas shipping container for up to three (3) months with no long term preparation.
3. John Deere engines can be stored inside, warehoused, for up to six (6) months with no long term preparation.
4. John Deere engines expected to be stored more than six (6) months, long term storage preparation MUST BE taken. (See PREPARING ENGINE FOR LONG TERM STORAGE, later in this section.)

RG, RG34710, 5610 -19-23NOV01-1/1

Preparing Engine for Long Term Storage

The following storage preparations are good for long term engine storage up to one year. After that, the engine should be started, warmed up, and retreated for an extended storage period.

IMPORTANT: Any time your engine will not be used for over six (6) months, the following recommendations for storing it and removing it from storage will help to minimize corrosion and deterioration.

1. Change engine oil and replace filter. Used oil will not give adequate protection. (See CHANGE ENGINE OIL AND FILTER in Lubrication and Maintenance/500 Hour Section.)
2. Service air cleaner. (See REPLACING AIR CLEANER FILTER ELEMENTS in Service As Required Section.)
3. Draining and flushing of cooling system is not necessary if engine is to be stored only for several months. However, for extended storage periods of a year or longer, it is recommended that the cooling system be drained, flushed, and refilled. Refill with appropriate coolant. (See RECOMMENDED ENGINE COOLANT in Fuels, Lubricants, and Coolant Section and ADDING COOLANT in Service As Required Section.)
4. Crank the engine several revolutions with starter (do not allow the engine to start).
5. Remove fan/alternator poly-vee belt, if desired.
6. Remove and clean batteries. Store them in a cool, dry place and keep them fully charged.
7. Disengage the clutch for any driveline.
8. Clean the exterior of the engine with salt-free water and touchup any scratched or chipped painted surfaces with a good quality paint.
9. Coat all exposed (machined) metal surfaces with grease or corrosion inhibitor if not feasible to paint.
10. Seal all openings on engine with plastic bags and tape.
11. Store the engine in a dry protected place. If engine must be stored outside, cover it with a waterproof canvas or other suitable protective material and use a strong waterproof tape.

RG, RG34710, 5612 -19-23NOV01-1/1

Removing Engine from Long Term Storage

Refer to the appropriate section for detailed services listed below or have your authorized servicing dealer or engine distributor perform services that you may not be familiar with.

1. Remove all protective coverings from engine. Unseal all openings in engine and remove covering from electrical systems.
2. Remove the batteries from storage. Install batteries (fully charged) and connect the terminals.
3. Install fan/alternator poly-vee belt if removed.
4. Fill fuel tank.
5. Perform all appropriate prestarting checks. (See DAILY PRESTARTING CHECKS in Lubrication and Maintenance/Daily Section.)

IMPORTANT: DO NOT operate starter more than 30 seconds at a time. Wait at least 2 minutes for starter to cool before trying again.

6. Crank engine for 20 seconds with starter (do not allow the engine to start). Wait 2 minutes and crank engine an additional 20 seconds to assure bearing surfaces are adequately lubricated.
7. Start engine and run at low idle and no load for several minutes. Warm up carefully and check all gauges before placing engine under load.
8. On the first day of operation after storage, check overall engine for leaks and check all gauges for correct operation.

RG, RG34710, 5613 -19-20MAY96-1/1

Specifications

General OEM Engine Specifications

ITEM	4045DF270	4045TF270	4045TF/HF275	4045HF475	6068TF/HF275	6068HF475
Number of Cylinders	4	4	4	4	6	6
Bore	106 mm (4.19 in.)	106 mm (4.19 in.)	106 mm (4.19 in.)	106 mm (4.19 in.)	106 mm (4.19 in.)	106 mm (4.19 in.)
Stroke	127 mm (5.0 in.)	127 mm (5.0 in.)	127 mm (5.0 in.)	127 mm (5.0 in.)	127 mm (5.0 in.)	127 mm (5.0 in.)
Displacement	4.5 L (276 cu in.)	4.5 L (276 cu in.)	4.5 L (276 cu in.)	4.5 L (276 cu in.)	6.8 L (414 cu in.)	6.8 L (414 cu in.)
Compression Ratio	17.6:1	17.0:1	17.0:1	17.0:1	17.0:1	17.0:1
Aspiration	Natural	Turbocharged	Turbocharged	Turbocharged	Turbocharged	Turbocharged
Engine Firing Order	1-3-4-2	1-3-4-2	1-3-4-2	1-3-4-2	1-5-3-6-2-4	1-5-3-6-2-4
Valves Per Cylinder	1 Intake 1 Exhaust	1 Intake 1 Exhaust	1 Intake 1 Exhaust	2 Intake 2 Exhaust	1 Intake 1 Exhaust	2 Intake 2 Exhaust
Valve Clearance (Cold) Intake (Checking)	0.31-0.38 mm (0.012-0.015 in)	0.31-0.38 mm (0.012-0.015 in)	0.31-0.38 mm (0.012-0.015 in)	0.31-0.38 mm (0.012-0.015 in)	0.31-0.38 mm (0.012-0.015 in)	0.31-0.38 mm (0.012-0.015 in)
Exhaust (Checking)	0.41-0.48 mm (0.016-0.019 in)	0.41-0.48 mm (0.016-0.019 in)	0.41-0.48 mm (0.016-0.019 in)	0.41-0.48 mm (0.016-0.019 in)	0.41-0.48 mm (0.016-0.019 in)	0.41-0.48 mm (0.016-0.019 in)
Intake (Adjusting)	0.36 mm (0.014 in.)	0.36 mm (0.014 in.)	0.36 mm (0.014 in.)	0.36 mm (0.014 in.)	0.36 mm (0.014 in.)	0.36 mm (0.014 in.)
Exhaust (Adjusting)	0.46 mm (0.018 in.)	0.46 mm (0.018 in.)	0.46 mm (0.018 in.)	0.46 mm (0.018 in.)	0.46 mm (0.018 in.)	0.46 mm (0.018 in.)
Max. Crank Pressure	0.5 kPa (2 H ₂ O)	0.5 kPa (2 H ₂ O)	0.5 kPa (2 H ₂ O)	0.5 kPa (2 H ₂ O)	0.5 kPa (2 H ₂ O)	0.5 kPa (2 H ₂ O)
Vibration Damper Maximum Radial Runout	1.50 mm (0.060 in.)	1.50 mm (0.060 in.)	1.50 mm (0.060 in.)	1.50 mm (0.060 in.)	1.50 mm (0.060 in.)	1.50 mm (0.060 in.)
Battery Capacities (CCA) 12-Volt System	640	640	640	640	800	800
24-Volt System	570	570	570	570	570	570
Governor Regulation (Industrial)	7—10 %	7—10 %	7—10 %	7—10 %	7—10 %	7—10 %
Governor Regulation (Generator)	5 %	5 %	5%	5%	5 %	5%
Thermostat Start To Open Temperature	82°C (180°F)	82°C (180°F)	82°C (180°F)	82°C (180°F)	82°C (180°F)	82°C (180°F)
Thermostat Fully Open Temperature	94°C (202°F)	94°C (202°F)	94°C (202°F)	94°C (202°F)	94°C (202°F)	94°C (202°F)
Coolant Capacity	8.5 L (9 qt)	8.5 L (9 qt)	8.5 L (9 qt)	8.5 L (9 qt)	11.3 L (12 qt)	11.3 L (12 qt)
Recommended Radiator Pressure Cap	70 kPa (10 psi)	70 kPa (10 psi)	70 kPa (10 psi)	70 kPa (10 psi)	70 kPa (10 psi)	70 kPa (10 psi)
Crankcase Oil Fill Capacity	See "Engine Crankcase Oil Fill Quantities" later in this section.					

Continued on next page

RG, RG34710, 5614 -19-28FEB03-1/2

Specifications

ITEM	4045DF270	4045TF270	4045TF/HF275	4045HF475	6068TF/HF275	6068HF475
Oil Pressure At Rated Speed, Full Load (± 15 psi)	345 kPa (50 psi)	345 kPa (50 psi)	345 kPa (50 psi)	345 kPa (50 psi)	345 kPa (50 psi)	345 kPa (50 psi)
Oil Pressure At Low Idle (Minimum)	105 kPa (15 psi)	105 kPa (15 psi)	105 kPa (15 psi)	105 kPa (15 psi)	105 kPa (15 psi)	105 kPa (15 psi)
Length	860 mm (33.9 in.)	860 mm (33.9 in.)	860 mm (33.9 in.)	860 mm (33.9 in.)	1123 mm (44.2 in.)	1123 mm (44.2 in.)
Width	612 mm (24.1 in.)	612 mm (24.1 in.)	612 mm (24.1 in.)	612 mm (24.1 in.)	623 mm (24.5 in.)	608 mm (23.9 in.)
Height	856 mm (33.7 in.)	994 mm (39.1 in.)	994 mm (39.1 in.)	994 mm (39.1 in.)	1015 mm (40.0 in.)	1044 mm (41.1 in.)
Weight	387 kg (853 lb)	451 kg (993 lb)	451 kg (993 lb)	451 kg (993 lb)	587 kg (1290 lb)	587 kg (1290 lb)

RG, RG34710, 5614 -19-28FEB03-2/2

Engine Power Ratings¹ And Fuel System Specifications²

Engine Model	Fuel System Option Codes	Electronic Software Option Codes	System Voltage	Power Rating @ Rated Speed kW (hp)	Rated Speed (rpm)	Slow Idle (rpm)	Fast Idle (rpm)
4045DF270 (Mechanical Controls)	164J	12V	36 (48)	2250	850	2450
	164K	24V	36 (48)	2250	850	2450
	164N	12V	60 (80)	2500	850	2700
	164O	24V	60 (80)	2500	850	2700
	164L	12V	55 (74)	2500	850	2700
	164M	24V	55 (74)	2500	850	2700
	162Q	12V	50 (67)	1800	1400	1870
	164P	12V	50 (67)	1800	1400	1870
164Q	24V	50 (67)	1800	1400	1870	
4045TF270 (Mechanical Controls)	164V	12V	74 (99)	2500	850	2700
	164W	24V	74 (99)	2500	850	2700
	164T	12V	74 (99)	2200	850	2400
	164U	24V	74 (99)	2200	850	2400
	163N, 164X	12V	74 (99)	1800	1400	1870
	164Y	24V	74 (99)	1800	1400	1870
	164R	12V	63 (84)	2500	850	2700
	164S	24V	63 (84)	2500	850	2700
4045TF275	161K, 163H	7288	12V	86 (115)	2500	800	2700
	161L, 163L	7289	24V	86 (115)	2500	800	2700
	161K, 163H	7290	12V	82 (110)	2400	800	2600
	161L, 163L	7291	24V	82 (110)	2400	800	2600
	161K, 163H	7292	12V	84 (112)	1800	1150	1870
	161L, 163L	7293	24V	84 (112)	1800	1150	1870
4045HF275	161F, 163G	7262	12V	104 (140)	2400	800	2600
	161G, 163K	7263	24V	104 (140)	2400	800	2600
	161F, 163G	7264	12V	93 (125)	2400	800	2600
	161G, 163K	7265	24V	93 (125)	2400	800	2600
	161F, 163G	72BD	12V	104 (140)	2200	800	2400
	161G, 163K	72BE	24V	104 (140)	2200	800	2400
	161F, 163G	7266	12V	93 (125)	2200	800	2400
	161G, 163K	7267	24V	93 (125)	2200	800	2400
	161F, 163G	7268	12V	86 (115)	2000	800	2100
	161G, 163K	7269	24V	86 (115)	2000	800	2100
	161F, 163G	7270	12V	108 (145)	1800	1150	1870
	161G, 163K	7271	24V	108 (145)	1800	1150	1870

¹Power ratings are for bare engines without drag effect of cooling fan or accessories like air compressors.

²Engine speeds listed are preset to factory specification. Slow idle speed may be reset depending upon specific vehicle application requirements. Refer to your machine operator's manual for engine speeds that are different from those preset at the factory.

Specifications

Engine Model	Fuel System Option Codes	Electronic Software Option Codes	System Voltage	Power Rating @ Rated Speed kW (hp)	Rated Speed (rpm)	Slow Idle (rpm)	Fast Idle (rpm)
4045HF275	161F, 163G	7272	12V	117 (157)	1800	1150	1870
	161G, 163K	7273	24V	117 (157)	1800	1150	1870
	161G, 163K	72BB	24V	93 (125)	2400	800	2600
	161F, 163G	12V	99 (133)	1500	1400	1575
	161G, 163K	24V	99 (133)	1500	1400	1575
4045HF475 (4-Valve Head)	161V	72AT	12V	129 (173)	2400	800	2600
	161V	72AU	12V	119 (160)	2200	800	2400
	161V	72AV	12V	143 (192)	1800	1400	1870
	161V	72AW	12V	120 (161)	1500	1400	1560
6068TF275	161J, 163M	72AA	24V	123 (165)	2400	800	2600
	161H, 163F	72AB	12V	101 (135)	2200	800	2400
	161J, 163M	72AC	24V	101 (135)	2200	800	2400
	161H, 163F	72AD	12V	112 (150)	2200	800	2400
	161J, 163M	72AE	24V	112 (150)	2200	800	2400
	161H, 163F	72AF	12V	104 (140)	2000	800	2100
	161J, 163M	72AG	24V	104 (140)	2000	800	2100
	161H, 163F	72AH	12V	123 (165)	1800	1150	1870
	161J, 163M	72AJ	24V	123 (165)	1800	1150	1870
	161H, 163F	7294	12V	116 (155)	2500	800	2700
	161J, 163M	7295	24V	116 (155)	2500	800	2700
	161H, 163F	7296	12V	127 (170)	2500	800	2700
	161J, 163M	7297	24V	127 (170)	2500	800	2700
	161H, 163F	7298	12V	123 (165)	2400	800	2600
	161H, 163F	12V	105 (141)	1500	1400	1575
	161H, 163F	24V	105 (141)	1500	1400	1575
6068HF275	16YS	7201, 7222, 7230	12V	168 (225)	2400	850	2600
	16YT	7202, 7223, 7231	24V	168 (225)	2400	850	2600
	16YS	7203, 7224, 7232	12V	149 (200)	2400	800	2600
	16YT	7204	24V	149 (200)	2400	850	2600
	16YS	7228, 7236	12V	149 (200)	2200	2400
	16YT	7297, 7237	24V	149 (200)	2200	2400
	16YS	7205, 7226, 7234	12V	138 (185)	2400	850	2600
	16YT	7206, 7227, 7235	24V	138 (185)	2400	850	2600
	16YS	7207	12V	149 (200)	2200	800	2400
	16YT	7208	24V	149 (200)	2200	800	2400
	16YS	7274	12V	187 (250)	2400	850	2600
	16YT	7275	24V	187 (250)	2400	850	2600
	16YS	7276	12V	168 (225)	2200	800	2400
	16YT	7277	24V	168 (225)	2200	800	2400
	16YS	7278	12V	157 (210)	2000	800	2100
	16YT	7279	24V	157 (210)	2000	800	2100
	161N, 163E	7280	12V	129 (173)	2000	800	2100
	161Q, 163J	7281	24V	129 (173)	2000	800	2100
	161N, 163E	7282	12V	164 (220)	1800	1150	1870
	161Q, 163J	7283	24V	164 (220)	1800	1150	1870
	16YS	7284	12V	187 (250)	1800	1150	1870
	16YT	7285	24V	187 (250)	1800	1150	1870
16YS, 162B	7286	12V	210 (282)	1800	1150	1870	

Continued on next page

OURGP11,0000157 -19-21JAN04-2/3

Specifications

Engine Model	Fuel System Option Codes	Electronic Software Option Codes	System Voltage	Power Rating @ Rated Speed kW (hp)	Rated Speed (rpm)	Slow Idle (rpm)	Fast Idle (rpm)
6068HF275	16YT, 162C	7287	24V	210 (282)	1800	1150	1870
	16YS	12V	138 (185)	1500	1400	1560
	16YT	24V	138 (185)	1500	1400	1560
	16YS	12V	175 (235)	1500	1400	1560
	16YT	24V	175 (235)	1500	1400	1560
6068HF475 4-Valve Head)	161U	72AP	12V	205 (275)	2400	800	2600
	165B	72CQ	24V	205 (275)	2400	800	2600
	161U	72AQ	12V	187 (250)	2200	800	2400
	165B	72CR	24V	187 (250)	2200	800	2400
	161U	72AR	12V	234 (314)	1800	1400	1870
	165B	72CS	24V	234 (314)	1800	1400	1870
	161U	72AS	12V	207 (278)	1500	1400	1560
	165B	72CT	24V	207 (278)	1500	1400	1560

OURGP11,0000157 -19-21JAN04-3/3

Engine Crankcase Oil Fill Quantities

To determine the option code for the oil fill quantity of your engine, refer to the engine option code label affixed to the rocker arm cover. The first two digits of the code (19) identify the oil pan option group. The last two digits of each code identify the specific oil pan on your engine.

NOTE: Crankcase oil capacity may vary slightly from amount shown. ALWAYS fill crankcase to within crosshatch on dipstick. DO NOT overfill.

The following table lists engine crankcase oil fill quantities:

Engine Model	Oil Pan Option Code(s)	Crankcase Oil Capacity L (qt)
4045DF270	1901	8.5 (9.0)
	1902	8.5 (9.0)
	1903	12.0 (12.7)
	1904	13.0 (13.7)
	1923	15.0 (15.8)
4045TF270	1903	12.0 (12.7)
	1904	13.0 (13.7)
	1923	15.0 (15.8)
4045TF275	1903	12.5 (13.2)
	1904	13.5 (14.3)
	1923	15.0 (15.8)
4045HF275	1904	13.5 (14.3)
	1923	15.0 (15.8)
	1976	20.5 (21.6)
4045HF475	1923	15.0 (15.8)
	1976	20.5 (21.6)
6068TF275	1907	19.5 (20.6)
	1908	19.0 (20.1)
	1909	19.0 (20.1)
	1924	24.2 (25.6)
	1944	20.0 (21.1)
	1956	18.0 (19.0)
	1961	31.5 (33.3)
	19AC	27.0 (28.5)
6068HF275	1907	19.5 (20.6)
	1908	19.0 (20.1)
	1909	19.0 (20.1)
	1924	24.2 (25.6)
	1961	31.5 (33.3)
6068HF475	1924	23.7 (25.0)
	1961	31.5 (33.3)
	19AC	27.0 (28.5)

Unified Inch Bolt and Screw Torque Values

TS1671 -UN-01MAY03

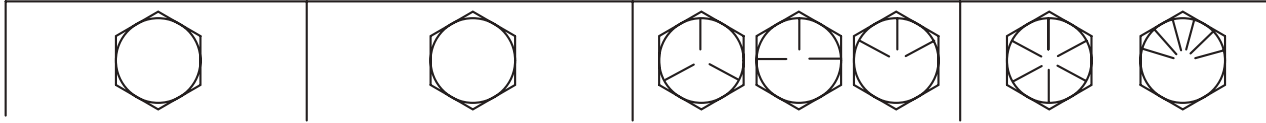

Bolt or Screw	SAE Grade 1				SAE Grade 2 ^a				SAE Grade 5, 5.1 or 5.2				SAE Grade 8 or 8.2			
	Lubricated ^b		Dry ^c		Lubricated ^b		Dry ^c		Lubricated ^b		Dry ^c		Lubricated ^b		Dry ^c	
Size	N•m	lb-in	N•m	lb-in	N•m	lb-in	N•m	lb-in	N•m	lb-in	N•m	lb-in	N•m	lb-in	N•m	lb-in
1/4	3.7	33	4.7	42	6	53	7.5	66	9.5	84	12	106	13.5	120	17	150
													N•m	lb-ft	N•m	lb-ft
5/16	7.7	68	9.8	86	12	106	15.5	137	19.5	172	25	221	28	20.5	35	26
									N•m	lb-ft	N•m	lb-ft				
3/8	13.5	120	17.5	155	22	194	27	240	35	26	44	32.5	49	36	63	46
			N•m	lb-ft	N•m	lb-ft	N•m	lb-ft								
7/16	22	194	28	20.5	35	26	44	32.5	56	41	70	52	80	59	100	74
	N•m	lb-ft														
1/2	34	25	42	31	53	39	67	49	85	63	110	80	120	88	155	115
9/16	48	35.5	60	45	76	56	95	70	125	92	155	115	175	130	220	165
5/8	67	49	85	63	105	77	135	100	170	125	215	160	240	175	305	225
3/4	120	88	150	110	190	140	240	175	300	220	380	280	425	315	540	400
7/8	190	140	240	175	190	140	240	175	490	360	615	455	690	510	870	640
1	285	210	360	265	285	210	360	265	730	540	920	680	1030	760	1300	960
1-1/8	400	300	510	375	400	300	510	375	910	670	1150	850	1450	1075	1850	1350
1-1/4	570	420	725	535	570	420	725	535	1280	945	1630	1200	2050	1500	2600	1920
1-3/8	750	550	950	700	750	550	950	700	1700	1250	2140	1580	2700	2000	3400	2500
1-1/2	990	730	1250	930	990	730	1250	930	2250	1650	2850	2100	3600	2650	4550	3350

Torque values listed are for general use only, based on the strength of the bolt or screw. DO NOT use these values if a different torque value or tightening procedure is given for a specific application. For plastic insert or crimped steel type lock nuts, for stainless steel fasteners, or for nuts on U-bolts, see the tightening instructions for the specific application. Shear bolts are designed to fail under predetermined loads. Always replace shear bolts with identical grade.

Replace fasteners with the same or higher grade. If higher grade fasteners are used, tighten these to the strength of the original. Make sure fastener threads are clean and that you properly start thread engagement. When possible, lubricate plain or zinc plated fasteners other than lock nuts, wheel bolts or wheel nuts, unless different instructions are given for the specific application.

^aGrade 2 applies for hex cap screws (not hex bolts) up to 6. in (152 mm) long. Grade 1 applies for hex cap screws over 6 in. (152 mm) long, and for all other types of bolts and screws of any length.

^b"Lubricated" means coated with a lubricant such as engine oil, fasteners with phosphate and oil coatings, or 7/8 in. and larger fasteners with JDM F13C zinc flake coating.

^c"Dry" means plain or zinc plated without any lubrication, or 1/4 to 3/4 in. fasteners with JDM F13B zinc flake coating.

Metric Bolt and Screw Torque Values

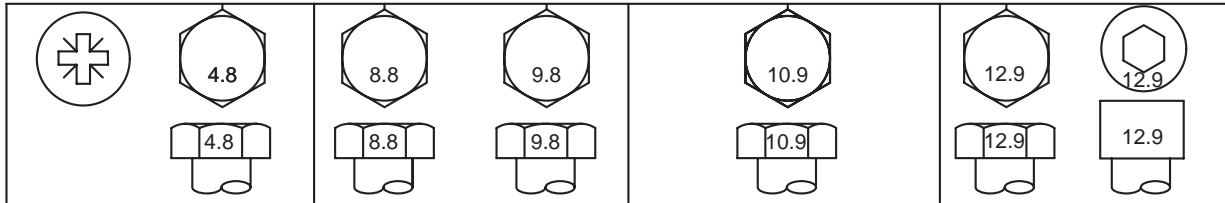

TS1670 -UN-01MAY03

Bolt or Screw	Class 4.8				Class 8.8 or 9.8				Class 10.9				Class 12.9			
	Lubricated ^a		Dry ^b		Lubricated ^a		Dry ^b		Lubricated ^a		Dry ^b		Lubricated ^a		Dry ^b	
Size	N•m	lb-in	N•m	lb-in	N•m	lb-in	N•m	lb-in	N•m	lb-in	N•m	lb-in	N•m	lb-in	N•m	lb-in
M6	4.7	42	6	53	8.9	79	11.3	100	13	115	16.5	146	15.5	137	19.5	172
									N•m	lb-ft	N•m	lb-ft	N•m	lb-ft	N•m	lb-ft
M8	11.5	102	14.5	128	22	194	27.5	243	32	23.5	40	29.5	37	27.5	47	35
			N•m	lb-ft	N•m	lb-ft	N•m	lb-ft								
M10	23	204	29	21	43	32	55	40	63	46	80	59	75	55	95	70
	N•m	lb-ft														
M12	40	29.5	50	37	75	55	95	70	110	80	140	105	130	95	165	120
M14	63	46	80	59	120	88	150	110	175	130	220	165	205	150	260	190
M16	100	74	125	92	190	140	240	175	275	200	350	255	320	235	400	300
M18	135	100	170	125	265	195	330	245	375	275	475	350	440	325	560	410
M20	190	140	245	180	375	275	475	350	530	390	675	500	625	460	790	580
M22	265	195	330	245	510	375	650	480	725	535	920	680	850	625	1080	800
M24	330	245	425	315	650	480	820	600	920	680	1150	850	1080	800	1350	1000
M27	490	360	625	460	950	700	1200	885	1350	1000	1700	1250	1580	1160	2000	1475
M30	660	490	850	625	1290	950	1630	1200	1850	1350	2300	1700	2140	1580	2700	2000
M33	900	665	1150	850	1750	1300	2200	1625	2500	1850	3150	2325	2900	2150	3700	2730
M36	1150	850	1450	1075	2250	1650	2850	2100	3200	2350	4050	3000	3750	2770	4750	3500

Torque values listed are for general use only, based on the strength of the bolt or screw. DO NOT use these values if a different torque value or tightening procedure is given for a specific application. For stainless steel fasteners or for nuts on U-bolts, see the tightening instructions for the specific application. Tighten plastic insert or crimped steel type lock nuts by turning the nut to the dry torque shown in the chart, unless different instructions are given for the specific application.

Shear bolts are designed to fail under predetermined loads. Always replace shear bolts with identical property class. Replace fasteners with the same or higher property class. If higher property class fasteners are used, tighten these to the strength of the original. Make sure fastener threads are clean and that you properly start thread engagement. When possible, lubricate plain or zinc plated fasteners other than lock nuts, wheel bolts or wheel nuts, unless different instructions are given for the specific application.

^a“Lubricated” means coated with a lubricant such as engine oil, fasteners with phosphate and oil coatings, or M20 and larger fasteners with JDM F13C zinc flake coating.

^b“Dry” means plain or zinc plated without any lubrication, or M6 to M18 fasteners with JDM F13B zinc flake coating.

Lubrication and Maintenance Records

Using Lubrication and Maintenance Records

Refer to specific Lubrication and Maintenance Section for detailed service procedures.

1. Keep a record of the number of hours you operate your engine by regular observation of hour meter.
2. Check your record regularly to learn when your engine needs service.
3. DO ALL the services within an interval section. Write the number of hours (from your service records) and the date in the spaces provided. For a

complete listing of all items to be performed and the service intervals required, refer to the quick-reference chart near the front of the Lubrication and Maintenance Section.

IMPORTANT: The service recommendations covered in this manual are for the accessories that are provided by John Deere. Follow manufacturer's service recommendations for servicing engine driven equipment not supplied by Deere.

RG, RG34710, 5620 -19-20MAY96-1/1

Daily (Prestarting) Service

- Check engine oil level.
- Check coolant level.
- Check fuel filters/water bowls.
- Check air cleaner dust unloader valve and air restriction indicator, if equipped.
- Perform visual walkaround inspection.

RG, RG34710, 5621 -19-11JUN02-1/1

500 Hour/12 Month Service

- Service fire extinguisher.
- Check engine mounts.
- Service battery.
- Check manual belt tensioner and belt wear.
- Change engine oil and filter.¹
- Check crankcase vent system.
- Check air intake hoses, connections, and system.
- Replace fuel filter element.
- Check automatic belt tensioner and belt wear.
- Check engine electrical ground connection.
- Check cooling system.
- Coolant solution analysis – add SCAs as needed.
- Pressure test cooling system.
- Check engine speeds.

Hours									
Date									
Hours									
Date									
Hours									
Date									
Hours									
Date									
Hours									
Date									
Hours									
Date									
Hours									
Date									
Hours									
Date									

¹If other than John Deere PLUS 50™ or ACEA-E4/E5 engine oil and the specified filter are used, the service interval for engine oil and filter is reduced to 250 hours.

2000 Hour/24 Month Service

- Check crankshaft vibration damper (6-cylinder only).
- Flush and refill cooling system.¹
- Test thermostats.
- Check and adjust valve clearance.
- Test glow plugs (4045HF475, 6068HF475)

Hours									
Date									
Hours									
Date									
Hours									
Date									
Hours									
Date									
Hours									
Date									
Hours									
Date									
Hours									
Date									
Hours									
Date									

¹If John Deere COOL-GARD is used, the flushing interval may be extended to 3000 hours, or 36 months. If John Deere COOL-GARD is used and the coolant is tested annually AND additives are replenished as needed by adding a supplemental coolant additive, the flushing interval may be extended to 5000 hours or 60 months, whichever occurs first.

Service as Required

- Add coolant
- Service air cleaner.
- Replace poly-vee belts.
- Check fuses
- Check air compressor (if equipped)
- Bleed fuel system

Hours									
Date									
Hours									
Date									
Hours									
Date									
Hours									
Date									
Hours									
Date									
Hours									
Date									
Hours									
Date									
Hours									
Date									

RG, RG34710, 5627 -19-11MAR03-1/1

Emission System Warranty

U.S. EPA Emissions Control Warranty Statement

Emissions control-related parts and components are warranted by John Deere for five years or 3000 hours of operation, whichever occurs first. John Deere further warrants that the engine covered by this warranty was designed, built, and equipped so as to conform at the time of sale with all U.S. emissions standards at the time of manufacture, and that it is free of defects in materials and workmanship which would cause it not to meet these standards within the period of five years or 3000 hours of operation, whichever occurs first.

Warranties stated in this manual refer only to emissions-related parts and components of your engine. The complete engine warranty, less emissions-related parts and components, is provided separately as the "John Deere New Off-Highway Engine Warranty".

RG, RG34710, 7629 -19-30JUN97-1/1

Emissions Control System Certification Label



Emissions Label

CAUTION: Statutes providing severe penalties for tampering with emissions controls may apply to the user or dealer.

The emissions warranty described below applies only to those engines marketed by John Deere that have been certified by the United States Environmental Protection Agency (EPA) and/or California Air Resources Board (CARB); and used in the United States and Canada in non-road mobile (self-propelled or portable/transportable¹) equipment. The presence of an emissions label like the one shown signifies that the engine has been certified with the EPA and/or CARB. The EPA and CARB warranties only apply to new

engines having the certification label affixed to the engine and sold as stated above in the geographic areas. The presence of an EU number in the third line of the label signifies that the engine has been certified with the European Union countries per Directive 97/68/EC. The emissions warranty does not apply to the EU countries.

NOTE: The hp/kW rating on the engine emissions certification label specifies the gross engine hp/kW, which is flywheel power without fan. In most applications this will not be the same rating as the advertised vehicle hp/kW rating.

¹Equipment moved at least once every 12 months.

John Deere Service Literature Available

Technical Information

Technical information is available from John Deere. Some of this information is available in electronic as well as printed form. Order from your John Deere dealer or call **1-800-522-7448**. Please have available the model number, serial number, and name of the product.

Available information includes:

- **PARTS CATALOGS** list service parts available for your machine with exploded view illustrations to help you identify the correct parts. It is also useful in assembling and disassembling.
- **OPERATOR'S MANUALS** providing safety, operating, maintenance, and service information. These manuals and safety signs on your machine may also be available in other languages.
- **OPERATOR'S VIDEO TAPES** showing highlights of safety, operating, maintenance, and service information. These tapes may be available in multiple languages and formats.
- **TECHNICAL MANUALS** outlining service information for your machine. Included are specifications, illustrated assembly and disassembly procedures, hydraulic oil flow diagrams, and wiring diagrams. Some products have separate manuals for repair and diagnostic information. Some components, such as engines, are available in separate component technical manuals
- **FUNDAMENTAL MANUALS** detailing basic information regardless of manufacturer:
 - Agricultural Primer series covers technology in farming and ranching, featuring subjects like computers, the Internet, and precision farming.
 - Farm Business Management series examines "real-world" problems and offers practical solutions in the areas of marketing, financing, equipment selection, and compliance.
 - Fundamentals of Services manuals show you how to repair and maintain off-road equipment.
 - Fundamentals of Machine Operation manuals explain machine capacities and adjustments, how to improve machine performance, and how to eliminate unnecessary field operations.



Parts Catalogs

RG9262 –UN–16MAR98



Operator Manuals

RG9260 –UN–16MAR98



Component Technical Manuals

RG9261 –UN–16MAR98



Fundamental Manuals

TS1663 –UN–10OCT97

DPSG, RG41165, 134 –19–10JUL00–1/1

Publications for this Engine

Technical information is available from John Deere in support of our products. Some of this information is available in electronic as well as printed form. Order from your John Deere dealer or call **1-800-522-7448**. Please have available the model number, and name of your engine.

Publications For *POWERTECH* 4.5 And 6.8 L Diesel Engines (English).

Publication Type	Title	Order Number
Operation And Maintenance Manual	<i>POWERTECH</i> 4.5 L and 6.8 L OEM Diesel Engines	OMRG33324
Parts Catalogs	<i>POWERTECH</i> 4.5 L OEM Diesel Engines (4045DF270, 4045TF270)	PC9355
	<i>POWERTECH</i> 4.5 L OEM Diesel Engines (4045TF275, 4045HF275, 4045HF475)	PC9080
	<i>POWERTECH</i> 6.8 L OEM Diesel Engines (6068TF275, 6068HF275, 6068HF475)	PC9081
Component Technical Manuals	<i>POWERTECH</i> 4.5 & 6.8 L Diesel Engines—	
	Base Engine	CTM104
	Mechanical Fuel Systems	CTM207
	Level 4 Electronic Fuel System With Bosch VP44 Pump	CTM170
	Level 12 Electronic Fuel System With Stanadyne DE10 Pump	CTM331
	Level 11 Electronic Fuel System With Denso High Pressure Common Rail	CTM220
	OEM Engine Accessories (English Only)	CTM67
	Alternators And Starter Motors	CTM77

DPSG,RG34710,105 -19-26FEB03-1/1

Index

	Page	Page
A		
Acid burns	30-2	
Adjust		
Valves, all except 475 engines	35-9	
Valves, 475 engines	35-12	
Air cleaner		
Air intake restriction indicator	25-1	
Dust unloader valve	25-1	
Replace single stage element	40-5	
Air compressor	40-11	
Air intake heaters	10-4	
Air intake system, check.	30-11	
Alternator belts	40-10	
Auxiliary gear drive, limitations	19-17, 20-3	
B		
Batteries		
Charge/Boost	19-11, 20-11	
Service	30-2	
Battery acid burns	30-2	
Battery explosion	30-2	
Belt tensioner		
Manual tensioner, adjust	30-4	
Manual tensioner, adjust with tool	30-5	
Belt tensioner, automatic	30-14	
Belts, fan and alternator		
Replacing	40-10	
Bleeding fuel system		
DE10 pump	40-14	
High Pressure Common Rail	40-17	
VP44 pump	40-12	
4045DF/TF270	40-19	
Blink codes		
Bosch VP44 pump	45-26	
High Pressure Common Rail	45-28	
Reading DTCs	45-20	
Break-in engine oil	10-6	
Break-in, engine		
Except 4045DF,TF270	19-1	
4045DF,TF270	20-2	
C		
Chart, service interval.	21-2, 21-4	
Check and adjust		
Valves, all except 475 engines	35-9	
Valves, 475 engines	35-12	
Check engine electrical ground.	30-16	
Cold weather aids.	10-4, 35-15	
Except 4045DF,TF270	19-9	
4045DF,TF270	20-6	
Compressor, air	40-11	
Configuration data, viewing - earlier engines	16-14	
Configuration data, viewing - later engines	17-6	
Coolant		
Adding	40-3	
Diesel engine	10-11	
Disposing	10-14	
Replenishing supplemental additives.	30-17	
Supplemental additives	10-13	
Testing	10-13, 30-19	
Warm temperature climates	10-14	
Cooling system		
Adding coolant	40-3	
Check	30-16	
Flush.	35-3	
Pressure test.	30-20	
Pressure test radiator cap.	30-20	
Refill	35-3	
Crankcase vent system, check.	30-9	
Crankshaft vibration damper.	35-2	
D		
Damper, checking.	35-2	
Diagnostic gauge		
Software version - later engines	45-31	
Diagnostic Procedure	45-22	
Diagnostic procedure		
Using diagnostic gauge - earlier engines	16-8	
Using diagnostic gauge - later engines	17-4	
Diagnostic trouble codes		
Blink codes	45-20	
Diagnostic trouble codes (DTCs)		
Active engine service codes, viewing - earlier engines	16-16	
Active engine service codes, viewing - later engines	17-10	
Electronic systems and Bosch VP44.	45-26	
Diagnostic Trouble Codes (DTCs)		
Electronic systems and Denso High Pressure Common Rail.	45-28	
Diagnostic trouble codes (DTCs)		
Electronic systems and Stanadyne DE10	45-24	
Diagnostic trouble codes (DTC's)		
Instrument panel	45-22	

	Page		Page
Diagnostic trouble codes (DTCs)		Engine wiring layout	
Stored service codes, viewing - earlier engines	16-17	With Bosch VP44 pump	45-4
Stored service codes, viewing - later engines	17-8	With Denso High Pressure Common Rail	45-5
Diesel engine oil	10-7	With Stanadyne DE10 pump	45-3
Diesel fuel	10-1, 10-3	Error Codes	45-30
DTCs (Diagnostic Trouble Codes)			
View active service codes - earlier engines	16-16	F	
View active service codes - later engines	17-10	Fan belts	40-10
View stored service codes - earlier engines	16-17	Filter, replace	
View stored service codes - later engines	17-8	Fuel	30-12
E		Oil	30-7
Emissions		Fire extinguisher, service	30-1
EPA Statement	65-1	Fuel	
Engine		Diesel	10-1, 10-3
Adjust speed	30-21	Handling and storing	10-2
Break-in, except 4045DF,TF270	19-1	Lubricity	10-1
Break-in, 4045DF,TF270	20-2	Fuel filter	
Changing speed	19-13	Checking	25-1
Check electrical ground	30-16	Draining water	25-1
Idling	19-12, 20-9	Replace	30-12
Operation, except 4045DF,TF270	19-7	Fuel injection pump model number	01-5
Operation, 4045DF,TF270	20-1	Fuel system	
Option codes	01-3	Bleeding (DE10 pump)	40-14
Serial number	01-1	Bleeding (High Pressure Common Rail)	40-17
Starting, except 4045DF,TF270 engine	19-4	Bleeding (VP44 pump)	40-12
Starting, 4045DF,TF270 engine	20-4	Bleeding (4045DF/TF270)	40-19
Stopping, except 4045DF,TF270	19-16	Fuses, checking	40-11
Stopping, 4045DF,TF270	20-10		
Troubleshooting	45-10	G	
Warming, except 4045DF,TF270	19-8	Gauges	
Warming, 4045DF,TF270	20-8	Except 4045DF,TF270	19-8
Engine coolant		4045DF,TF270	20-8
Disposing of	10-14	Generator (Standby) Applications	21-4
Engine mounts, check	30-1	Glow plugs	
Engine oil		Test, 475 engines	35-15
Break-In	10-6	Grease	
Change	30-7	Extreme pressure and multipurpose	10-10
Diesel	10-7		
Extended Service Intervals	10-8	I	
Engine speed		Idling engine	19-12, 20-9
Changing	19-13	Instrument panels	
Engine wiring diagram		Adjust backlighting - later engines	17-13
W/electronic instrument panel	45-6	Adjust contrast - later engines	17-15

Page	Page		
Changing units of measure - earlier engines	16-12	Fill quantity	55-6
Changing units of measure - later engines	17-17	Filler locations	25-1
Component function - earlier engines	16-1	Oil filter, change	30-7
Component function - later engines	17-1	Operating engine	
identification	15-1	Break-in, except 4045DF,TF270	19-1
Main menu navigation - later engines	17-5	Break-in, 4045DF,TF270	20-2
Setup 1-up display - later engines	17-20	Cold weather	10-4
Setup 4-up display - later engines	17-26	Cold weather, except 4045DF,TF270	19-9
Shutdown codes - later engines	17-12	Cold weather, 4045DF,TF270	20-6
Touch switches - earlier engines	16-10	Normal operation, except 4045DF,TF270	19-7
Using diagnostic gauge - earlier engines	16-8	Normal operation, 4045DF,TF270	20-1
Using diagnostic gauge - later engines	17-4	Option codes	01-3
Viewing active service codes - earlier engines	16-16		
Viewing active service codes - later engines	17-10	P	
Viewing configuration data - earlier engines	16-14	Poly-vee belts	
Viewing configuration data - later engines	17-6	Replace	40-10
Viewing stored service codes - earlier engines	16-17	Power ratings	55-3
Viewing stored service codes - later engines	17-8	Precautions for welding on engines equipped w/ECU	45-2
Intermittent fault diagnostics	45-31		
		R	
L		Radiator cap testing	30-20
Listing of DTCs.	45-24, 45-26, 45-28	Radiator shutters	10-4
Lubricant		Recordkeeping	
Mixing	10-8	Engine option codes	01-3
Storage	10-10	Engine serial number	01-1
Lubrication and Maintenance		Injection pump model number	01-5
Service Interval Chart	21-2, 21-4		
Lubricity of diesel fuel.	10-1	S	
		Serial number	
M		Engine	01-1
Maintenance interval chart		Fuel injection pump	01-5
Generator (Standby) applications	21-4	Service	
Standard industrial applications	21-2	Battery	30-2
Manual belt tensioner	30-4	Fire extinguisher	30-1
Manual belt tensioner - using belt tension tool	30-5	Intervals	21-2, 21-4
Mixing lubricants.	10-8	Service Intervals	
		Extended Diesel Engine Oil	10-8
O		Service intervals	
Oil		General information	21-1
Dipstick	25-1	Service literature	70-2
		Specifications	
		Battery capabilities	30-2
		Belt tensioner	30-14

Page	Page		
Damper	35-2	475 engines.	35-12
Engine crankcase oil fill	55-6	Vibration damper	35-2
Fuel injection pump and power ratings	55-3		
General OEM	55-1	W	
Standby power units.	19-17, 20-4	Warming engine, except 4045DF,TF270	19-8
Starting engine, except 4045DF,TF270		Warming engine, 4045DF,TF270	20-8
engine.	19-4	Warranty	
Starting engine, 4045DF,TF270 engine	20-4	Emission System	65-2
Stopping engine, except 4045DF,TF270.	19-16	Winterfronts	10-4
Stopping engine, 4045DF,TF270	20-10	Wiring diagrams, engine	
Storage		Engines w/electronic instrument panel	45-6
Guidelines.	50-1	Wiring harness	
Long term	50-2	With Bosch VP44 pump	45-4
Removing from	50-3	With Denso High Pressure Common Rail	45-5
Storing fuel.	10-2	With Stanadyne DE10 pump.	45-3
Storing lubricants	10-10		
Supplemental coolant additives			
Replenishing.	30-17		
T			
Tensioner, belt			
Automatic	30-14		
Manual	30-4		
Thermostat			
Install	35-6		
Remove	35-6		
Test opening temperature	35-6		
Touch switches - earlier engines	16-10		
Trouble codes			
Electronic systems and Bosch VP44.	45-26		
Electronic systems and Denso High Pressure			
Common Rail.	45-28		
Electronic systems and Stanadyne DE10	45-24		
Troubleshooting			
General, engine	45-10		
U			
Units of measure, changing - earlier engines	16-12		
Units of measure, changing - later engines	17-17		
V			
Valves			
Clearance, check and adjust			
All except 475 engines	35-9		